

# 5G/IoT APPLICATION GUIDE



CAPACITORS | FUSES | VARISTORS | CONNECTORS | DIODES |  
ANTENNAS | 5G MMWAVE CHAMBER | FILTERS | INDUCTORS



# 5G/IoT PRODUCT GUIDE

## COMMUNICATION

### PASSIVE ANTENNAS FOR IoT

- Application notes available with standard antennas for easier system integration
- Excellent isolation due to patented Isolated Magnetic Dipole™ Technology
- R&D and manufacturing facilities all over the globe
- Tuning capabilities for performance optimization
- Evaluation boards available with standard on-board antennas

IoT Antennas Series Include: [X9001248](#), [1004795/1004796](#), [1002436](#), [1002289](#), [1000146](#), [P822601/P822602](#)



Scan the QR code to visit our Online Search Filter for Passive Antennas

### BAND SWITCHING FOR IoT

- Ideal for meeting harsh specifications when bandwidth of antenna is reduced
- Optimizes the antenna's direction in real-time on a per millisecond basis
- Major increase in range, reliability, and data rate between devices
- Ultra-low loss SP4T switches

EtherChip Series Include: [EC646](#) and [EC686-3](#)

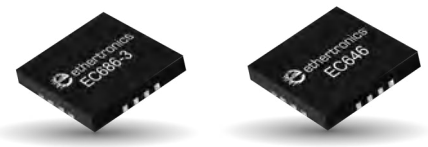

#### Typical Tuning and Efficiency Behavior

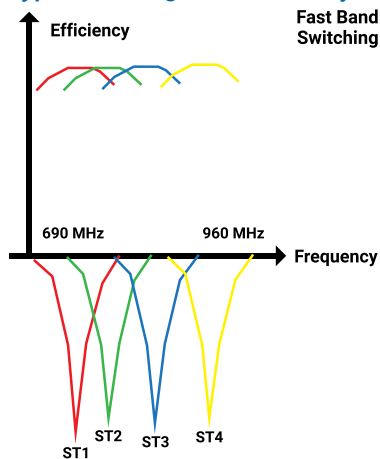

#### Typical Switch & Tune Diagram

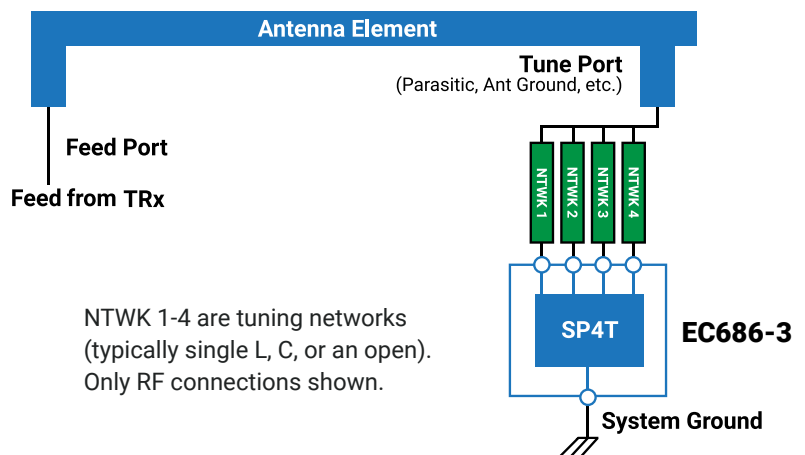

### TEST SERVICES FOR IoT ANTENNAS

ITS-00X for ISM / LoRa / Sigfox – LTS-00X for NB-IoT / LTE-M

Automotive Testing Chamber is available for large/heavy devices (e.g. washing machines or parking meters).

TEST	MEASUREMENT
<b>ITS-001 OR LTS-001</b> <i>Passive Testing in Anechoic Chamber</i>	Full characterization, measurement, & analysis of passive performance *Benchmark Testing Possible
<b>ITS-002 OR LTS-002</b> <i>Antenna Optimization &amp; Passive Testing in Anechoic Chamber</i>	Antenna matching and performance optimization. Full characterization, measurement, & analysis of passive performance
<b>ITS-003</b> <i>Active Testing in Anechoic Chamber</i>	Active tests of full system: TRP (CW mode)
<b>ITS-004 OR LTS-003</b> <i>Active Testing in Anechoic Chamber</i>	Active tests of full system: TRP/TIS (LoRa, NB-IoT, LTE-M)
<b>ITS-005 OR LTS-005</b> <i>RF Simulations</i>	EM simulation for antenna design

# COMMUNICATION

## 5G SUB-6GHZ and mmWAVE

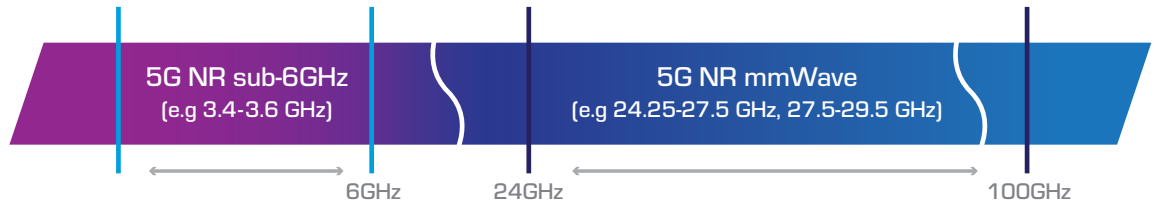

### PASSIVE ANTENNAS FOR 5G SUB-6GHZ

- Application notes available with standard antennas for easier system integration
- Excellent isolation due to patented Isolated Magnetic Dipole™ Technology
- R&D and manufacturing facilities all over the globe
- Tuning capabilities for performance optimization
- Evaluation boards available with standard on-board antennas

5G Antennas Series Include: [1004795/1004796](#), [1000146](#), [P822601/P822602](#)

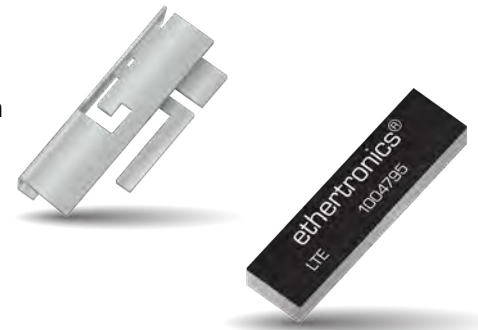

### MMWAVE TESTING FOR 5G ANTENNAS

TEST	MEASUREMENT
<b>mmWTS-001</b> Passive Testing Fixed Array Configuration	Full characterization, measurement, & analysis of passive antenna performance
<b>mmWTS-002</b> Passive Testing Beam forming Array Configuration	
<b>mmWTS-003</b> 5G Non-Signaling Active Testing	TRP testing with CW signal
<b>mmWTS-004</b> 5G Signaling Active Testing	TRP/TIS testing with 5G emulator. *Dependent upon availability of local third-party equipment*
<b>mmWTS-005</b> 5G mmWave Chamber Rental	Includes logistics, setup, tear down & operator training

### 5G MMWAVE CHAMBER

#### KEY FEATURES

**Technology:** Far-field / Spherical with oversampling

**Frequency Range:** 18GHz – 75GHz

**Maximum Size of DUT:** 45cm

**Maximum Mass of DUT:** 10kg on the mast

**Typical Dynamic Range:** 50db

#### MEASUREMENT CAPABILITIES (PASSIVE & ACTIVE)

Gain	Sidelobe Levels
Directivity	3D Radiation Pattern
Efficiency	Radiation Pattern in any Polarization
Beamwidth	TRP, TIS, EIRP & EIS
Cross Polar Discrimination	

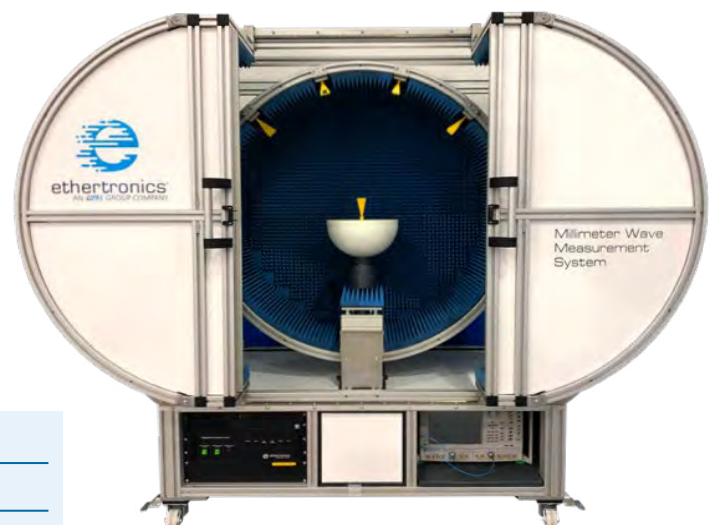

Scan the QR code to learn more about our 5G Chamber.

# POWER

## SUPERCAPACITORS

- Customizability of increasing working voltage or capacitance through series/parallel combinations
- Superior to batteries in cycle life, charge/discharge time, depth of discharge, & temperature range
- Very low ESR characteristics make them ideal for pulse power applications
- Large energy storage ability for backup and energy harvesting

Series Include: [SCM and SCC Series](#)

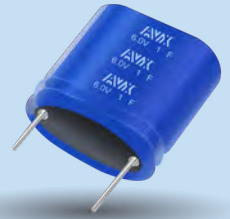

## BULK CAPACITANCE

### Tantalum Capacitors

- Lowest DCL product offering
- Smallest case size MnO<sub>2</sub>
- Four manufacturing plants worldwide
- Highest temperature capabilities up to 230°C
- Flexibility and capacity for the demanding electronic industry
- Global leader in MnO<sub>2</sub> solid tantalum technologies



### Polymer Capacitors

- High capacitance in small and low profiles
- Highest reliability polymer in hermetically sealed package (Elektra award 2015)
- Highest voltage in the industry, over 100Vr (Elektra award 2010)
- Highest energy density Joules / cc.
- Smallest case size 0402, 0603, 0805
- Benign failure mode
- Low ESR

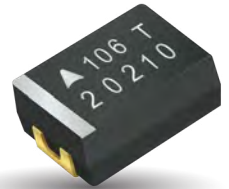
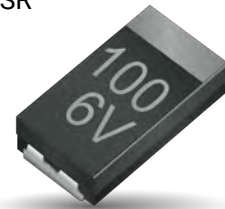

### Niobium Oxide Capacitors

- High CV
- Low ESR and Low Profile
- Up to 125°C and multi-anode technologies
- High safety technology with non-burning high resistance failure mode and high break down voltage
- Highest reliability level in commercial range products

## HIGH FREQUENCY DECOUPLING

- 60% Reduced Equivalent Series Inductance compared to traditional MLCCs
- 0306 / 0508 / 0612 sizes available

Series Include: [LICC, InterDigitated Capacitor, & Land Grid Array](#)

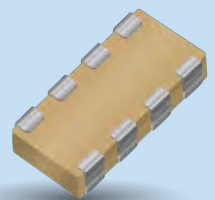
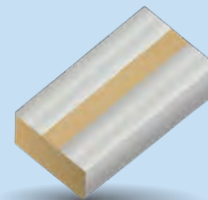

## THERMAL MANAGEMENT

- More efficient thermal management
- High thermal conductivity
- Low Capacitance (6fF - 0.2pF)
- Increases circuit reliability

Series Include: [Q-Bridge](#)

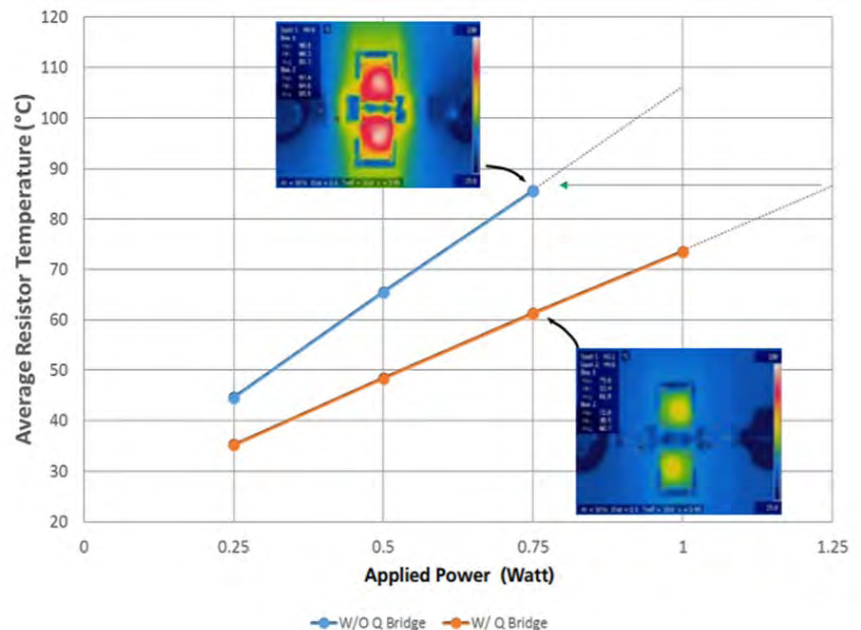

## CIRCUIT PROTECTION

### MULTILAYER VARISTOR

- High speed data lines/RF circuits
- High energy
- High temperature
- Harsh environment varistors

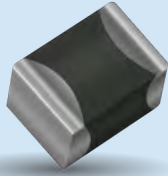

Series Include: **TransGuard® & AntennaGuard®**

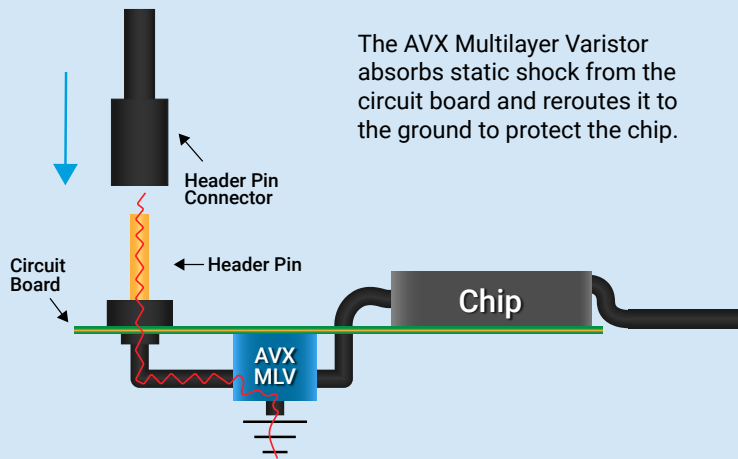

### FUSES

- Highly accurate current ratings: 28mA to 5A
- Typical lifetime: 20,000 hours
- Post fusing resistance >20MΩ

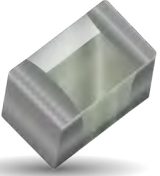

Series Include: **Accu-Guard® & Accu-Guard®-II**

### TVS DIODES

- Voltages below 12v and cap values as low as 0.3pf
- GG series complies with IEC 61000-4-2 (ESD)
- Level 4+ ( $\pm 20\text{kV}$  air,  $\pm 20\text{kV}$  contact discharge)
- IEC 61000-4-4 (electrical fast transient-EFT) (20A, 5/50 ns)
- Very fast charged device model (CDM) ESD and cable discharge event (CDE)
- Protects sensitive ICs during ESD events
- Standard EIA 0201/0402 components

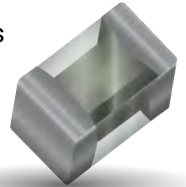

Series Include: **GiGuard® (GG) Series**

## COMMUNICATION

### RF FILTERS

- High part to part repeatability
- Low insertion loss and high rejection
- Sharp roll-off and excellent temperature stability
- Available in standard sizes across a wide range of frequencies

Series Include: **Thin Film, Multi-layer Organic**

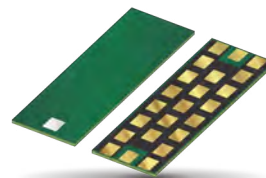

### RF CAPACITORS AND INDUCTORS

- Great RF performance and repeatability
- High Q and low ESR
- High self resonance frequency
- Tight tolerance

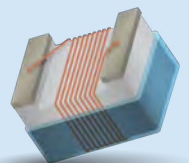
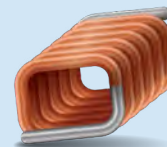
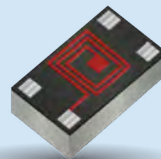
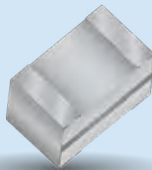

RF Capacitor Series Include: **Accu-P®, MLO®, 100, 111, 116, 200, 520, 530, 531, 560, 600, 700, 800, 900, U Series**

RF Inductor Series Include: **Accu-L®, MLO®, AL Series, AS Series, LCCI Series, LCWC Series**

### RF COAX CABLE INSULATION DISPLACEMENT CONNECTOR

- Can replace costly traditional RF connector systems
- Good RF performance up to 6GHz
- Mechanically strong with peel off force up to 70N
- Easy assembly process with ability to automate
- On-board height is less than 5mm

Series Include: **6791 Series**



## ABOUT AVX

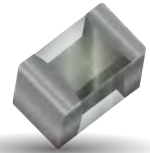
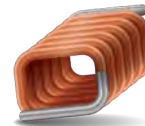

AVX is a worldwide leading supplier of passive electronic components, connectors, passive and active antennas, sensors and control units. AVX offers a wide range of components manufactured to the highest quality and reliability standards.

Our products include ceramic, solid electrolytic and film capacitors, pulse supercapacitors, varistors, thermistors, filters, inductors, diodes, antennas, connectors, sensors and control units. Our worldwide manufacturing capability includes facilities located in seventeen countries on four continents, allowing us to continue meeting customer needs on a global basis.

AVX is committed to supporting the needs of its customers for applications today and in the future. Together with continuous quality improvement process, AVX components provide reliable solutions for consumer application needs.

As a technology leader, AVX will continue to add to its product portfolio on a regular basis. Details of new devices being offered and their specifications will be shown on the AVX website.

**NORTH AMERICA**  
Tel: +1 864-967-2150

**CENTRAL AMERICA**  
Tel: +55 11-46881960

**EUROPE**  
Tel: +44 1276-697000

**ASIA**  
Tel: +65 6286-7555

**JAPAN**  
Tel: +81 740-321250