

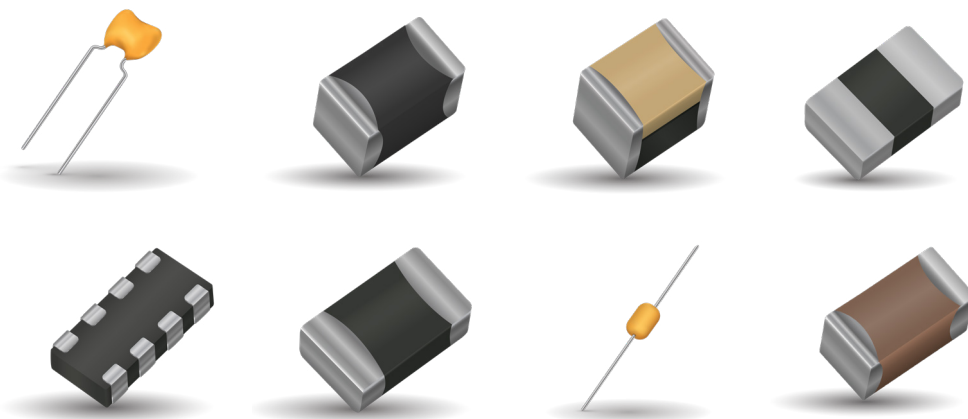

# Transient Suppression Products



## IMPORTANT INFORMATION/DISCLAIMER

All product specifications, statements, information and data (collectively, the “Information”) in this datasheet or made available on the website are subject to change. The customer is responsible for checking and verifying the extent to which the Information contained in this publication is applicable to an order at the time the order is placed. All Information given herein is believed to be accurate and reliable, but it is presented without guarantee, warranty, or responsibility of any kind, expressed or implied.

Statements of suitability for certain applications are based on AVX’s knowledge of typical operating conditions for such applications, but are not intended to constitute and AVX specifically disclaims any warranty concerning suitability for a specific customer application or use.

**ANY USE OF PRODUCT OUTSIDE OF SPECIFICATIONS OR ANY STORAGE OR INSTALLATION INCONSISTENT WITH PRODUCT GUIDANCE VOIDS ANY WARRANTY.**

The Information is intended for use only by customers who have the requisite experience and capability to determine the correct products for their application. Any technical advice inferred from this Information or otherwise provided by AVX with reference to the use of AVX’s products is given without regard, and AVX assumes no obligation or liability for the advice given or results obtained.

Although AVX designs and manufactures its products to the most stringent quality and safety standards, given the current state of the art, isolated component failures may still occur. Accordingly, customer applications which require a high degree of reliability or safety should employ suitable designs or other safeguards (such as installation of protective circuitry or redundancies) in order to ensure that the failure of an electrical component does not result in a risk of personal injury or property damage.

Unless specifically agreed to in writing, AVX has not tested or certified its products, services or deliverables for use in high risk applications including medical life support, medical device, direct physical patient contact, water treatment, nuclear facilities, weapon systems, mass and air transportation control, flammable environments, or any other potentially life critical uses. Customer understands and agrees that AVX makes no assurances that the products, services or deliverables are suitable for any high-risk uses. Under no circumstances does AVX warrant or guarantee suitability for any customer design or manufacturing process.

Although all product–related warnings, cautions and notes must be observed, the customer should not assume that all safety measures are indicated or that other measures may not be required.

# Transient Suppression Products

## Table of Contents



### INTRODUCTION

Introduction.....	2
Multilayer Ceramic Transient Voltage Suppressors	
Product Selection Guide .....	4

### PRODUCT CATALOG

TransGuard® .....	7
TransGuard® Automotive Series .....	16
Low Clamp Automotive TransGuard® .....	26
StaticGuard .....	29
StaticGuard Automotive Series .....	32
Miniature 0201 Automotive MLV .....	35
MultiGuard® Series .....	37
UltraGuard® Series .....	42
Communication BUS Varistor .....	45
USB Series .....	49
AntennaGuard Series .....	53
AntennaGuard Automotive Series .....	57
Antenna PowerGuard.....	60
AntennaGuard® Series Sub pF .....	65
AntennaGuard Automotive Series Sub pF .....	67
Controlled Capacitance Multilayer Varistor .....	70
Miniature AC Varistor – MAV .....	72
Glass Encapsulated TransGuard® .....	75
Glass Encapsulated TransGuard® Automotive Series .....	77
High Temp. Automotive VT Series .....	79
High Temp. Automotive CAN Series.....	86
High Temp. Low Leakage Automotive Varistors .....	88
Radial Leaded Automotive TransGuard® .....	90
Radial Leaded High Temp. Automotive TransGuard® .....	92
Radial Leaded CapGuard® .....	94
Surface Mount CapGuard™ .....	96
Axial TransGuard® and StaticGuard.....	98
TransFeed® .....	100
TransFeed® Automotive Series.....	107
SnPb Multilayer Varistors .....	112
Glass Encapsulated MLV.....	114

### APPLICATION GUIDE

General Applications (TransGuard®).....	127
Automotive Application (TransGuard®) .....	133

### APPLICATION NOTES

TransGuard® .....	143
IEC 61000-4 Requirements	
Turn on Time Characteristics of AVX Multilayer Varistors	
The Impact of ESD on Insulated Portable Equipment	
Motor and Relay Application Study	
Multilayer Varistors In Automobile MUX Bus Applications	

### SOLDERING – ASSEMBLY GUIDELINES

TransGuard® .....	155
-------------------	-----

### PACKAGING

Paper Carrier Configuration .....	160
Embossed Carrier Configuration.....	161
Packaging of Chip Components .....	162
Axial (Leads/Packaging).....	163
Radial Leads/Packaging .....	164





# Introduction

- Introduction
- Product Selection Guide

# Introduction

## Multilayer Ceramic Transient Voltage Suppressors

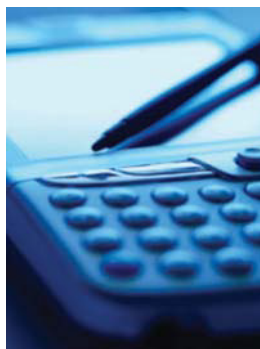

### AVX TRANSGUARD - MULTILAYER VARISTORS

The AVX TransGuard® Varistors - Transient Voltage Suppressors (TVS) with unique high-energy multilayer construction represent state-of-the-art overvoltage circuit protection. Monolithic multilayer construction provides protection from voltage transients caused by ESD (e.g. IEC 61000-4-2), lightning, inductive switching, automotive related transients such as load dump (ISO 7637-2-5), jump start with and other automotive transients (e.g. ISO 7637 Pulse 1-3, AEC-Q200-002, ISO 10605, ISO 16750-2, CI-220, CI-260) and more.

AVX varistors provide bi-directional transient voltage protection in the on-state and EMI/RFI attenuation in the off-state which allows designers to combine the circuit protection and EMI/RFI attenuation function into a single highly reliable device. Parts are designed for use in temperatures from -55°C to +125°C (+150°C components available) with no derating, exhibit very fast response, multiple strikes capability and high reliability. In addition, AVX automotive series varistors are AEC-Q200 qualified.

AVX Varistors are provided in different mounting options, covering wide range of applications requirements. Surface mount varistors are available in single element or multiple element (array) EIA industry standard packages. The parts are RoHS compliant and offer excellent solderability thanks to Ni Barrier/100% Sn termination; Pd/Ag parts for hybrid assembly are also available as option upon request. AVX also offers SnPb termination as a special option. Thru-hole components are supplied as conformally epoxy coated axial and radial devices and are RoHS compliant.

### BENEFITS AND FEATURES

- SMT 0201 - 3220, Axial and Radial configuration
- Bi Directional transient voltage protection
- EMI Filtering in the off-state
- Very fast response (< 1ns)
- Multiple strikes capability
- High reliability
- No derating over operating temperature range -55°C to +125°C (+150°C components available)
- High peak current and high energy options
- Low capacitance parts for RF, high speed data lines and capacitance sensitive applications
- AEC-Q200 qualified automotive series
- RoHS Compliant

### APPLICATIONS

AVX Varistors are used in wide range of application sectors such as:

- Automotive
- Consumer
- Home appliances
- Automation
- Lighting
- Industrial/Professional
- Medical
- Renewable/Smart Energy
- Military

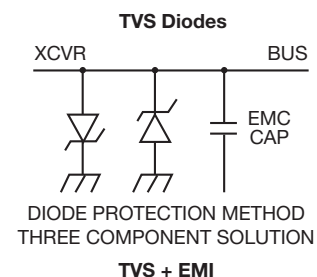
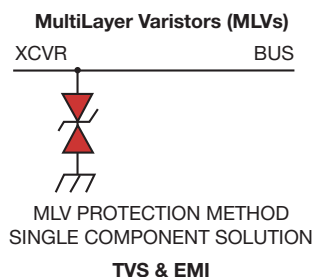

# Introduction

## Multilayer Ceramic Transient Voltage Suppressors

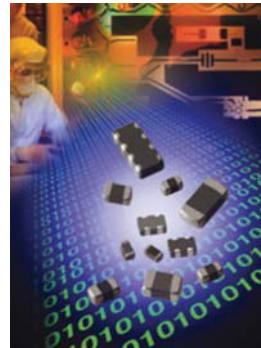

### TRANSGUARD<sup>®</sup> DESCRIPTION

TransGuard<sup>®</sup> products are zinc oxide (ZnO) based ceramic semiconductor devices with non-linear voltage-current characteristics (bi-directional) similar to back-to-back zener diodes. They have the added advantage of greater current and energy handling capabilities as well as EMI/RFI attenuation. Devices are fabricated by a ceramic sintering process that yields a structure of conductive ZnO grains surrounded by electrically insulating barriers, creating varistor-like behavior.

AVX VG series parts (large case size, high energy) are glass encapsulated. These parts provide the same high reliability as traditional VC series parts. The glass encapsulation provides enhanced resistance against harsh environment or process such as acids, salts, chlorite flux.

The number of grain-boundary interfaces between conducting electrodes determines "Breakdown Voltage" of the device. High voltage applications such as AC line protection require many grains between electrodes while low voltage requires few grains to establish the appropriate breakdown voltage. Single layer ceramic disc processing proved to be a viable production method for thick cross section devices with many grains, but attempts to address low voltage suppression needs by processing single layer ceramic disc formulations with huge grains has had limited success.

AVX, the world leader in the manufacture of multilayer ceramic capacitors, now offers the low voltage transient protection marketplace a true multilayer, monolithic surface mount varistor. Technology leadership in processing thin dielectric materials and patented processes for precise ceramic grain growth have yielded superior energy dissipation in the smallest size. Now a varistor has voltage characteristics determined by design and not just cell sorting whatever falls out of the process.

Multilayer ceramic varistors are manufactured by mixing ceramic powder in an organic binder (slurry) and casting it into thin layers of precision thickness. Metal electrodes are deposited onto the green ceramic layers which are then stacked to form a laminated structure. The metal electrodes are arranged so that their terminations alternate from one end of the varistor to the other. The device becomes a monolithic block during the sintering (firing) cycle providing uniform energy dissipation in a small volume.

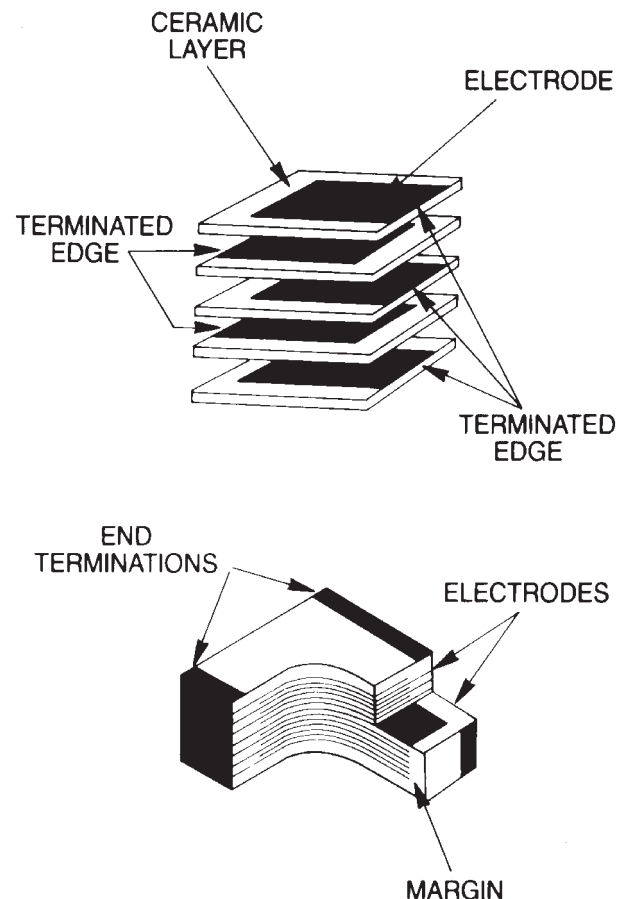

# Product Selection Guide

## Multilayer Ceramic Transient Voltage Suppressors

### AVX VARISTORS – PRODUCT SELECTION GUIDE

Series	PN Code	Fig.	Technical Data	Features / Applications	Page
TransGuard <sup>®</sup>	VC VG		Case size: 0402 - 3220 Working Voltage: 3.3 - 85Vdc Energy: 0.05J - 12J Peak Current: 20A - 2000A	Wide range of multilayer varistors for bi-directional overvoltage protection as well as EMI/RFI attenuation.	5-13
TransGuard <sup>®</sup> Automotive Series	VCAS VGAS		Case size: 0402 - 3220 Working Voltage: 5.6 - 85Vdc Energy: 0.05J - 13J Peak Current: 20A - 2000A	Wide range multilayer varistors for bi-directional overvoltage protection as well as EMI/RFI attenuation in automotive applications (AEC-Q200).	14-23
StaticGuard	VC**LC		Case size: 0402 - 1206 Working Voltage: 18Vdc Energy: 0.02J - 0.1J Capacitance: 40 - 200pF	Lower capacitance version of TransGuard <sup>®</sup> for bi-directional ESD protection as well as EMI/RFI attenuation.	24-26
StaticGuard Automotive Series	VCAS**LC		Case size: 0402 - 0805 Working Voltage: 18Vdc Energy: 0.02 - 0.1J Capacitance: 40 - 80pF	Lower capacitance version of TransGuard <sup>®</sup> for bi-directional ESD protection as well as EMI/RFI attenuation in automotive applications (AEC-Q200).	27-29
Miniature 0201 MLV	VC0201		Case size: 0201 Working Voltage: 3.5 - 16Vdc Energy: 0.01, 0.02J Peak Current: 1 - 10A	Miniature 0201 varistor for any circuits with space constraints or for embedded applications.	30-31
MultiGuard Array	MG		Case size: 0405 - 0612 Working Voltage: 5.6 - 18Vdc Energy: 0.02 - 0.1J Peak Current: 15 - 30A	2 and 4-element MLV arrays to protect multiple lines against ESD while saving board space and pick and place costs.	32-36
UltraGuardLow Leakage Varistors	VCUG MGUG		Case size: 0402 - 0612 Working Voltage: 3.0 - 32Vdc Energy: 0.02 - 0.4J Peak Current: 10 - 150A	Low leakage (<1μA) varistors for battery operated devices, high clock speed IC, low voltage power conversion circuits and low leakage requirements.	37-39
Communication Bus Varistors	CAN FLX		Case size: 0402 - 0612 Working Voltage: 18, 32Vdc Peak Current: 4 - 15A Capacitance: 15 - 50pF	Low capacitance varistors designed for protection of communication bus, data lines and other capacitance sensitive automotive (AEC-Q200) as well as general applications.	40-43
Low Capacitance USB Series	USB		Case size: 0402 - 0612 Working Voltage: 18Vdc Peak Current: 4A Capacitance: 3 - 10pF	Low capacitance varistors designed for use in high-speed data lines and other capacitance sensitive applications.	44-47
AntennaGuard Low Capacitance Varistors	VC**AG		Case size: 0402 - 0603 Working Voltage: 18Vdc Capacitance: 2 - 12pF	Low capacitance varistors designed for protection in RF circuits, antennas, sensors, high-speed data lines, optic circuits and other capacitance sensitive applications etc.	48-51
AntennaGuard Low Capacitance Automotive Series	VCAS**AG		Case size: 0402 - 0603 Working Voltage: 18Vdc Capacitance: 2 - 12pF	Low capacitance varistors designed for protection in RF circuits, antennas, sensors, high-speed data lines, optic circuits and capacitance sensitive applications in automotive applications (AEC-Q200).	52-54
AntennaGuard PowerGuard Low Capacitance Varistors	VCAS**AP		Case size: 0402 - 0603 Working Voltage: 18 - 30Vdc Capacitance: 1.5 - 3.3pF	Low capacitance varistors with higher energy rating and low signal distortion designed for protection in RF circuits, high-speed data lines, radars and other capacitance sensitive automotive (AEC-Q200). and general applications.	55-57
Sub pF AG Series Ultra-Low Capacitance	VCH4**AG		Case size: 0201, 0402 Working Voltage: 10 - 18Vdc Capacitance: 0.47 - 0.8pF	Ultra-low capacitance (<1pF) varistors designed for protection in RF circuits, antennas, sensors, high-speed data lines, optic circuits and capacitance sensitive applications.	58-59
Sub pF AG Automotive Series Ultra-Low Capacitance	VCASH4		Case size: 0402 Working Voltage: 16Vdc Capacitance: 0.8pF	Ultra-low capacitance (<1pF) varistor designed for protection in RF circuits, sensors, high-speed data lines, optic circuits and capacitance sensitive automotive (AEC-Q200) applications.	60-62
Controlled Capacitance	VCAC		Case size: 0402, 0603 Working Voltage: 9 - 30Vdc Peak Current: 2 - 120A Capacitance: 33 - 1000pF	Varistors developed for use in mixed signal environment for targeted EMI/RFI filtering and transient suppression in automotive (AEC-Q200) and general applications.	63-64

# Product Selection Guide

## Multilayer Ceramic Transient Voltage Suppressors

Series	PN Code	Fig.	Technical Data	Features / Applications	Page
Miniature MAV Series	MAV		Case size: 0402 - 0603 Working Voltage: 70Vdc Peak Current: 1 - 3A Capacitance: 6-22pF	Varistors designed for low power AC circuit protection, transient suppression in LC resonant circuits and higher DC voltage data lines protection in automotive (AEC-Q200) and general applications.	65-67
Glass Encapsulated TransGuard <sup>®</sup>	VG		Case size: 1206 - 3220 Working Voltage: 16 -125Vdc Energy: 0.7 - 12J Peak Current: 200 - 2000A	High energy range extension of TransGuard varistors. In addition the glass encapsulation provides enhanced resistance against harsh environment.	68-69
Glass Encapsulated TransGuard <sup>®</sup> Automotive Series	VGAS		Case size: 1206 - 3220 Working Voltage: 16 - 85Vdc Energy: 0.7 - 13J Peak Current: 200 - 2000A	High energy range extension of TransGuard automotive series varistors for automotive (AEC-Q200) applications. In addition the glass encapsulation provides enhanced resistance against harsh environment.	70-71
High Temperature Automotive Series	CANAT VCAT		Case size: 0603 - 0612 Working Voltage: 18Vdc Peak Current: 4A Capacitance: 12, 22pF	High temperature varistors specified to +150°C for automotive (AEC-Q200) and general applications.	72-73
High Temperature Low Leakage Automotive Series	CANATL		Case size: 0603 Working Voltage: 32Vdc Peak Current: 5A Capacitance: 10pF	High temperature varistors with low leakage, specified to +150°C for high temperature automotive (AEC-Q200) and general applications.	74-75
Radial Leaded Automotive TransGuard <sup>®</sup>	VR**AS		Case size: Radial Working Voltage: 18 - 48Vdc Energy: 0.7 - 1.6J Peak Current: 200 - 500A	Radial leaded epoxy coated varistors, designed for durability in harsh environments for automotive (AEC-Q200) and general applications.	76-77
Radial Leaded High Temperature Automotive TransGuard <sup>®</sup>	VR**AT		Case size: Radial Working Voltage: 14 - 48Vdc Energy: 0.1 - 2.0J Peak Current: 30 - 250A	High temperature, radial leaded epoxy coated varistors, specified to +150°C. Designed for durability in harsh environments and for high temperature automotive (AEC-Q200) and general applications.	78-79
Radial CapGuard™	CG		Case size: Radial Working Voltage: 26, 45Vdc Peak Current: 200A Capacitance: 0.47, 1pF	TransGuard varistor and RF filtering high capacitance ceramic capacitor integrated into single radial leaded component for bi-directional overvoltage protection and RFI noise suppression in automotive (AEC-Q200) and general applications.	80-81
Axial TransGuard and StaticGuard	VA		Case size: Axial Working Voltage: 3.3 - 60Vdc Energy: 0.1 - 2.0J Peak Current: 30 - 300A	Axial Version of TransGuard <sup>®</sup> and StaticGuard varistors for bi-directional overvoltage protection as well as EMI/RFI attenuation in the off-state.	84-85
TransFeed	V*F		Case size: 0805 Working Voltage: 5.6 - 26Vdc Energy: 0.05 - 0.3J Peak Current: 20 - 120A	Varistor with FeedThru filter construction for transient protection with enhanced attenuation characteristics for EMI reduction.	86-92
TransFeed Automotive Series	V*AF		Case size: 0805 Working Voltage: 5.6 - 26Vdc Energy: 0.05 - 0.3J Peak Current: 15 - 120A	Varistor with FeedThru filter construction for transient protection with enhanced attenuation characteristics for EMI reduction for automotive (AEC-Q200) applications.	93-97
SnPb Multilayer Varistors	VCLD		Case size: 0603 - 1210 Working Voltage: 5.6 - 85Vdc Energy: 0.1 - 2.0J Peak Current: 30 - 500A	Varistors with SnPb termination for bi-directional overvoltage protection as well as EMI/RFI attenuation in the off-state.	98-99
Glass Encapsulated MLV	VJ		Case size: 1206 - 3220 Working Voltage: 16 - 385Vdc Energy: 0.3 - 15J Peak Current: 120 - 3000A	Special series of high energy, large case size varistors for automotive, industrial/commercial and telecom applications.	100-111





# Product Catalog

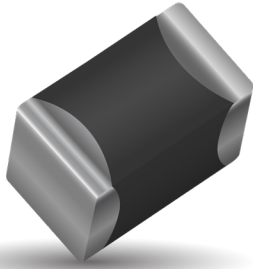

### GENERAL DESCRIPTION

TransGuard® multilayer varistors are zinc oxide (ZnO) based ceramic semiconductor devices with non-linear voltage-current characteristics (bi-directional) similar to back-to-back zener diodes. They have the added advantage of greater current and energy handling capabilities as well as EMI/RFI attenuation.

The increasing use of electronics technologies in all areas require reliable protection against transient voltages that could damage the electronics circuitry as well as EMI/RFI attenuation to prevent signal distortion and to meet regulatory requirements. AVX TransGuard components help achieve both functions with single component.

### GENERAL CHARACTERISTICS

- Operating Temperature: -55°C to +125°C
- Working Voltage: 3.3 - 85Vdc
- Case Size: 0402 - 1812
- Energy: 0.05 - 4.2J
- Peak Current: 20 - 2000A

### FEATURES

- Bi-Directional protection
- Very fast response to ESD strikes
- Multi-strike capability
- High Reliability
- EMI/RFI Filtering
- Wide range of components

### APPLICATIONS

- IC Protection
- Micro Controllers
- Relays
- I/O Ports
- Keyboard Protection
- Portable devices
- Industrial Controllers
- Automation
- Smart Grid
- Telecom
- LED Lights
- Cameras
- Base Stations
- Motion detector
- Alarms
- and more

### HOW TO ORDER

VC T Varistor Chip	1206 T Case Size	18 T Working Voltage	D T Energy Rating	400 T Clamping Voltage	R T Packaging	P T Termination			
VC = Varistor Chip VG = Varistor Glass	0402 0603 0805 1206 1210 1812 2220 3220	03 = 3.3Vdc 05 = 5.6Vdc 09 = 9Vdc 12 = 12Vdc 14 = 14Vdc 16 = 16Vdc 18 = 18Vdc 22 = 22Vdc 26 = 26Vdc 30 = 30Vdc	31 = 31Vdc 38 = 38Vdc 42 = 42Vdc 45 = 45Vdc 48 = 48Vdc 56 = 56Vdc 60 = 60Vdc 65 = 65Vdc 85 = 85Vdc	X= 0.05J A= 0.1J B= 0.2J C= 0.3J D= 0.4J E= 0.5J F= 0.7J G= 0.9J H= 1.2J J= 1.5-1.6J K= 0.6J	M= 1.0J N= 1.1J P= 2.5-3.7J R= 1.7J L= 0.8J S= 1.9-2.0J U= 4.0-5.0J W= 5.1-6.0J Y= 6.5-12J	100 = 12V 150 = 18V 200 = 22V 250 = 27V 300 = 32V 380 = 38V 390 = 42V 400 = 42V 440 = 44V 490 = 49V 540 = 54V 560 = 60V 570 = 57V 580 = 60V	620 = 67V 650 = 67V 770 = 77V 800 = 80V 900 = 90V 101 = 100V 111 = 110V 121 = 120V 131 = 135V 151 = 150V 161 = 165V	D = 7" (1000)* R = 7" (4000 or 2000)* T = 13" (10,000)* W = 7" (10,000)**  *Not available for 0402 **Only available for 0402	P = Ni/Sn plated

ELECTRICAL CHARACTERISTICS

AVX PN	V <sub>w</sub> (DC)	V <sub>w</sub> (AC)	V <sub>R</sub>	V <sub>C</sub>	I <sub>VC</sub>	I <sub>L</sub>	E <sub>T</sub>	I <sub>p</sub>	Cap	Freq	Case
	Vdc	Vac	V	V	A	µA	J	A	pF		
VC060303A100	3.3	2.3	5.0±20%	12	1	100	0.1	30	1450	K	0603
VC080503A100	3.3	2.3	5.0±20%	12	1	100	0.1	40	1400	K	0805
VC080503C100	3.3	2.3	5.0±20%	12	1	100	0.3	120	5000	K	0805
VC120603A100	3.3	2.3	5.0±20%	12	1	100	0.1	40	1250	K	1206
VC120603D100	3.3	2.3	5.0±20%	12	1	100	0.4	150	4700	K	1206
VC040205X150	5.6	4.0	8.5±20%	18	1	35	0.05	20	175	M	0402
VC060305A150	5.6	4.0	8.5±20%	18	1	35	0.1	30	750	K	0603
VC080505A150	5.6	4.0	8.5±20%	18	1	35	0.1	40	1100	K	0805
VC080505C150	5.6	4.0	8.5±20%	18	1	35	0.3	120	3000	K	0805
VC120605A150	5.6	4.0	8.5±20%	18	1	35	0.1	40	1200	K	1206
VC120605D150	5.6	4.0	8.5±20%	18	1	35	0.4	150	3000	K	1206
VC040209X200	9.0	6.4	12.7±15%	22	1	25	0.05	20	175	M	0402
VC060309A200	9.0	6.4	12.7±15%	22	1	25	0.1	30	550	K	0603
VC080509A200	9.0	6.4	12.7±15%	22	1	25	0.1	40	750	K	0805
VC080512A250	12.0	8.5	16±15%	27	1	25	0.1	40	525	K	0805
VC040214X300	14.0	10.0	18.5±12%	32	1	15	0.05	20	85	K	0402
VC060314A300	14.0	10.0	18.5±12%	32	1	15	0.1	30	350	K	0603
VC080514A300	14.0	10.0	18.5±12%	32	1	15	0.1	40	325	K	0805
VC080514C300	14.0	10.0	18.5±12%	32	1	15	0.3	120	900	K	0805
VC120614A300	14.0	10.0	18.5±12%	32	1	15	0.1	40	600	K	1206
VC120614D300	14.0	10.0	18.5±12%	32	1	15	0.4	150	1050	K	1206
VC121016J390	16.0	13.0	25.5±10%	40	2.5	10	1.6	500	3100	K	1210
VG181216P390	16.0	11.0	24.5±10%	40	5	15	2.9	1000	7000	K	1812
VG181216P400	16.0	11.0	24.5±10%	42	5	10	2.9	1000	5000	K	1812
VG222016Y400	16.0	11.0	24.5±10%	42	10	10	7.2	1500	13000	K	2220
VC040218X400	18.0	13.0	25.5±10%	42	1	10	0.05	20	65	M	0402
VC060318A400	18.0	13.0	25.5±10%	42	1	10	0.1	30	150	K	0603
VC080518A400	18.0	13.0	25.5±10%	42	1	10	0.1	30	225	K	0805
VC080518C400	18.0	13.0	25.5±10%	42	1	10	0.3	100	550	K	0805
VC120618A400	18.0	13.0	25.5±10%	42	1	10	0.1	30	350	K	1206
VC120618D400	18.0	13.0	25.5±10%	42	1	10	0.4	150	900	K	1206
VC120618E380	18.0	13.0	25.5±10%	38	1	15	0.5	200	930	K	1206
VG121018J380	18.0	14.0	22±10%	38	2.5	15	1.5	400	2300	K	1210
VC121018J390	18.0	13.0	25.5±10%	42	5	10	1.6	500	3100	K	1210
VG181218P380	18.0	14	22±10%	38	5	15	2.3	800	5000	K	1218
VG181218P440	18.0	14.0	27.5±10%	44	5	15	2.9	800	5000	K	1812
VG222018W380	18.0	14.0	22±10%	38	10	15	5.8	1200	18000	K	2220
VG121022R440	22.0	17.0	27±10%	44	2.5	15	1.7	400	1600	K	1210
VG222022Y440	22.0	17.0	27±10%	44	10	15	7.2	1200	18000	K	2220
VG222022Y490	22.0	17.0	30±10%	49	10	15	6.8	1200	12000	K	2220
VC060326A580	26.0	18.0	34.5±10%	60	1	10	0.1	30	155	K	0603
VC080526A580	26.0	18.0	34.5±10%	60	1	10	0.1	30	120	K	0805
VC080526C580	26.0	18.0	34.5±10%	60	1	10	0.3	100	250	K	0805
VC120626D580	26.0	18.0	34.5±10%	60	1	10	0.4	120	500	K	1206
VC120626F540	26.0	20.0	33.0±10%	54	1	15	0.7	200	600	K	1206
VC121026H560	26.0	18.0	34.5±10%	60	5	10	1.2	300	2150	K	1210
VG121026S540	26.0	20.0	33±10%	54	2.5	15	1.9	400	1600	K	1210
VG181226P540	26.0	20	35±10%	54	5	15	3	800	3000	K	1812

ELECTRICAL CHARACTERISTICS

AVX PN	V <sub>w</sub> (DC)	V <sub>w</sub> (AC)	V <sub>B</sub>	V <sub>C</sub>	I <sub>Vc</sub>	I <sub>L</sub>	E <sub>T</sub>	I <sub>p</sub>	Cap	Freq	Case
	Vdc	Vac	V	V	A	µA	J	A	pF		
VG181226P570	26.0	23.0	35.0±10%	57	5	15	2.5	600	3000	K	1812
VG181226P540	26.0	20.0	35.0±10%	54	5	15	3.0	800	3000	K	1812
VG222026Y540	26.0	20.0	33.0±10%	54	10	15	7.8	1200	11000	K	2220
VG222026Y570	26.0	23.0	35.0±10%	57	10	15	6.8	1100	7000	K	2220
VG322026N570	26.0	20.0	33.0±10%	57	10	15	1.1	400	5500	K	3220
VC060330A650	30.0	21.0	41.0±10%	67	1	10	0.1	30	125	K	0603
VC080530A650	30.0	21.0	41.0±10%	67	1	10	0.1	30	90	M	0805
VC080530C650	30.0	21.0	41.0±10%	67	1	10	0.3	80	250	K	0805
VC120630D650	30.0	21.0	41.0±10%	67	1	10	0.4	120	400	K	1206
VC121030G620	30.0	21.0	41.0±10%	67	5	10	0.9	220	1750	K	1210
VC121030H620	30.0	21.0	41.0±10%	67	5	10	1.2	280	1850	K	1210
VC121030S620	30.0	21.0	41.0±10%	67	5	10	1.9	300	1500	K	1210
VC080531C650	31.0	25.0	39.0±10%	65	1	10	0.3	80	250	K	0805
VC120631M650	31.0	25.0	39.0±10%	65	1	15	1.0	200	500	K	1206
VG121031R650	31.0	25.0	39.0±10%	65	2.5	15	1.7	300	1200	K	1210
VG181231P650	31.0	25.0	39.0±10%	65	5	15	3.7	800	2600	K	1812
VG222031Y650	31.0	25.0	39.0±10%	65	10	15	9.6	1200	6100	K	2220
VC080538C770	38.0	30.0	47.0±10%	77	1	10	0.3	80	200	K	0805
VC120638N770	38.0	30.0	47.0±10%	77	1	15	1.1	200	400	K	1206
VG121038S770	38.0	30.0	47.0±10%	77	2.5	15	2.0	400	1000	K	1210
VG181238U770	38.0	30.0	47.0±10%	77	5	15	4.2	800	1300	K	1812
VG222038Y770	38.0	30.0	47.0±10%	77	10	15	12	2000	4200	K	2220
VG322038J920	38.0	30.0	47.0±10%	92	10	15	1.5	400	2600	K	3220
VC120642L800	42.0	32.0	51.0±10%	80	1	15	0.8	180	600	K	1206
VC120645K900	45.0	35.0	56.0±10%	90	1	15	0.6	200	260	K	1206
VG121045S900	45.0	35.0	56.0±10%	90	2.5	15	2	300	800	K	1210
VG181245U900	45.0	35.0	56.0±10%	90	5	15	4.0	500	1200	K	1812
VG222045Y900	45.0	35.0	56.0±10%	90	10	15	12	1000	5000	K	2220
VC120648D101	48.0	34.0	62.0±10%	100	1	10	0.4	100	225	K	1206
VC121048G101	48.0	34.0	62.0±10%	100	5	10	0.9	220	450	K	1210
VC121048H101	48.0	34.0	62.0±10%	100	5	10	1.2	250	500	K	1210
VC120656F111	56.0	40.0	68.0±10%	110	1	15	0.7	100	180	K	1206
VG121056P111	56.0	40.0	68.0±10%	110	2.5	15	2.3	250	500	K	1210
VG181256U111	56.0	40.0	68.0±10%	110	5	15	4.8	500	800	K	1812
VG222056Y111	56.0	40.0	68.0±10%	110	10	15	9	1000	2000	K	2220
VC121060J121	60.0	42.0	76.0±10%	120	5	10	1.5	250	400	K	1210
VC120665L131	65.0	50.0	82.0±10%	135	1	15	0.8	100	250	K	1206
VC120665M131	65.0	50.0	82.0±10%	135	1	15	1.0	150	250	K	1206
VG121065P131	65.0	50.0	82.0±10%	135	2.5	15	2.7	350	600	K	1210
VG181265U131	65.0	50.0	82.0±10%	135	5	15	4.5	400	600	K	1812
VG222065Y131	65.0	50.0	82.0±10%	135	10	15	6.5	800	3000	K	2220
VC121085S151	85.0	60.0	100±10%	150	1	35	2.0	250	275	K	1210
VG181285U161	85.0	60.0	100±10%	165	5	15	4.5	400	500	K	1812
VG222085Y161	85.0	60.0	100±10%	165	10	15	6.8	800	1500	K	2220

V<sub>w</sub> (DC) DC Working Voltage (V)

V<sub>w</sub> (AC) AC Working Voltage (V)

V<sub>B</sub> Typical Breakdown Voltage (V @ 1mA<sub>DC</sub>)

V<sub>C</sub> Clamping Voltage (V @ I<sub>Vc</sub>)

I<sub>Vc</sub> Test Current for V<sub>C</sub> (A, 8x20µS)

I<sub>L</sub> Maximum Leakage Current at the Working Voltage (µA)

E<sub>T</sub> Transient Energy Rating (J, 10x1000µS)

I<sub>p</sub> Peak Current Rating (A, 8x20µS)

Cap Typical Capacitance (pF) @ frequency specified and 0.5 V<sub>RMS</sub>

Freq Frequency at which capacitance is measured (K = 1kHz, M = 1MHz)

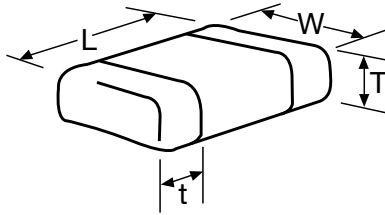

### DIMENSIONS:

mm (inches)

AVX Style		0402	0603	0805	1206	1210	1812	2220	3220
(L) Length	mm (in.)	1.00±0.10 (0.040±0.004)	1.60±0.15 (0.063±0.006)	2.01±0.20 (0.079±0.008)	3.20±0.20 (0.126±0.008)	3.20±0.20 (0.126±0.008)	4.50±0.30 (0.177±0.012)	5.70±0.40 (0.224±0.016)	8.20±0.40 (0.323±0.016)
(W) Width	mm (in.)	0.50±0.10 (0.020±0.004)	0.80±0.15 (0.031±0.006)	1.25±0.20 (0.049±0.008)	1.60±0.20 (0.063±0.008)	2.49±0.20 (0.098±0.008)	3.20±0.30 (0.126±0.012)	5.00±0.40 (0.197±0.016)	5.00±0.40 (0.197±0.016)
(T) Max Thickness	mm (in.)	0.6 (0.024)	0.9 (0.035)	1.02 (0.040)	1.02 (0.040) 1.27 (0.050) <sup>1)</sup> 1.70 (0.067) <sup>2)</sup>	1.70 (0.067)	2.00 (0.080)	2.50 (0.098)	2.50 max. (0.098 max.)
(t) Land Length	mm (in.)	0.25±0.15 (0.010±0.006)	0.35±0.15 (0.014±0.006)	0.71 max. (0.028 max.)	0.94 max. (0.037 max.)	1.14 max. (0.045 max.)	1.00 max. (0.039 max.)	1.00 max. (0.039 max.)	1.30 max. (0.051 max.)

1) Applicable for: VC120618E380

2) Applicable for: VC120626F540, VC120631M650, VC120638N770, VC120642L800, VC120645K900, VC120656F111, VC120660M131

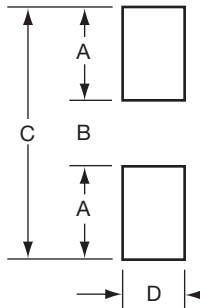

### SOLDERING PAD:

mm (inches)

Pad Layout	0402	0603	0805	1206	1210	1812	2220	3220
A	1.61 (0.024)	0.89 (0.035)	1.02 (0.040)	1.02 (0.040)	1.02 (0.040)	1.00 (0.039)	1.00 (0.039)	2.21 (0.087)
B	1.51 (0.020)	0.76 (0.030)	1.02 (0.040)	2.03 (0.080)	2.03 (0.080)	3.60 (0.142)	4.60 (0.18)	5.79 (0.228)
C	1.70 (0.067)	2.54 (0.100)	3.05 (0.120)	4.06 (0.160)	4.06 (0.160)	5.60 (0.220)	6.60 (0.26)	10.21 (0.402)
D	1.51 (0.020)	0.76 (0.030)	1.27 (0.050)	1.65 (0.065)	2.54 (0.100)	3.00 (0.118)	5.00 (0.20)	5.50 (0.217)

### TYPICAL PERFORMANCE CURVES (0402 CHIP SIZE)

#### VOLTAGE/CURRENT CHARACTERISTICS

Multilayer construction and improved grain structure result in excellent transient clamping characteristics up to 20 amps peak current, while maintaining very low leakage currents under DC operating conditions. The VI curves below show the voltage/current characteristics for the 5.6V, 9V, 14V, 18V and low capacitance StaticGuard parts with currents ranging from parts of a micro amp to tens of amps.

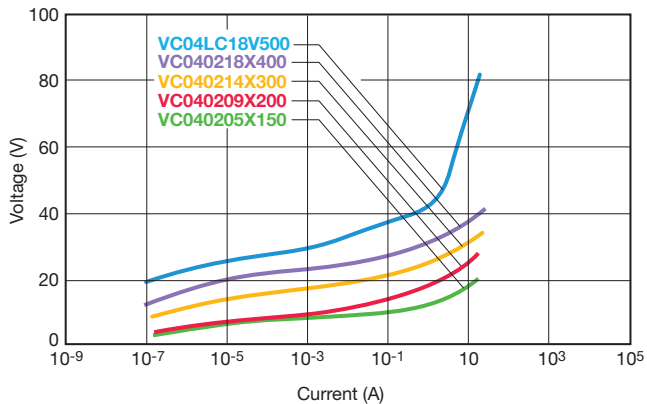

#### PULSE DEGRADATION

Traditionally varistors have suffered degradation of electrical performance with repeated high current pulses resulting in decreased breakdown voltage and increased leakage current. It has been suggested that irregular intergranular boundaries and bulk material result in restricted current paths and other non-Schottky barrier paralleled conduction paths in the ceramic. Repeated pulsing of TransGuard® transient voltage suppressors with 150Amp peak 8 x 20µs waveforms shows negligible degradation in breakdown voltage and minimal increases in leakage current.

#### ESD TEST OF 0402 PARTS

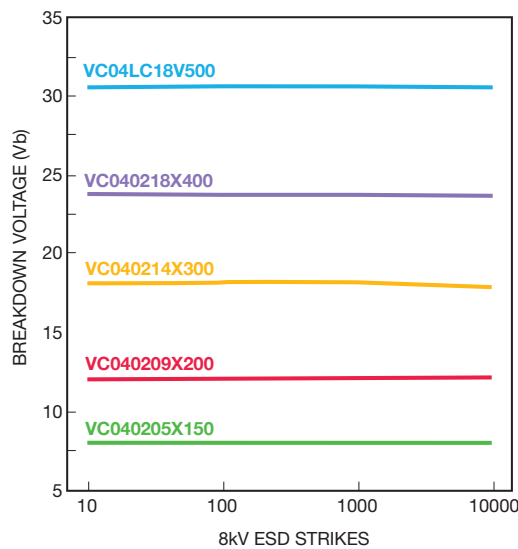

#### PEAK POWER VS PULSE DURATION

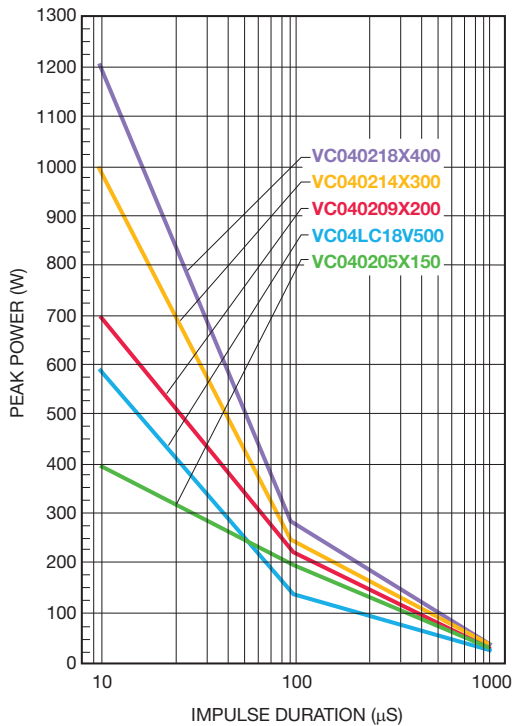

#### INSERTION LOSS CHARACTERISTICS

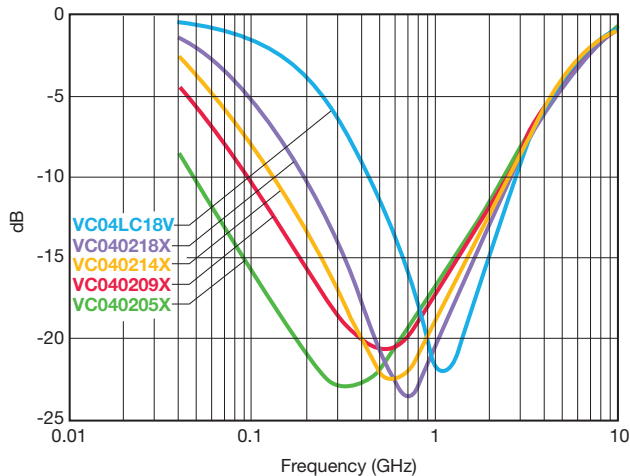

**TYPICAL PERFORMANCE CURVES (0603, 0805, 1206 & 1210 CHIP SIZES)**

**VOLTAGE/CURRENT CHARACTERISTICS**

Multilayer construction and improved grain structure result in excellent transient clamping characteristics up to 500 amps peak current, depending on case size and energy rating, while maintaining very low leakage currents under DC operating conditions. The VI curve below shows the voltage/current characteristics for the 3.3V, 5.6V, 12V, 14V, 18V, 26V, 30V, 48V and 60VDC parts with currents ranging from parts of a micro amp to tens of amps.

**VI Curves - 3.3V and 5.6V Products**

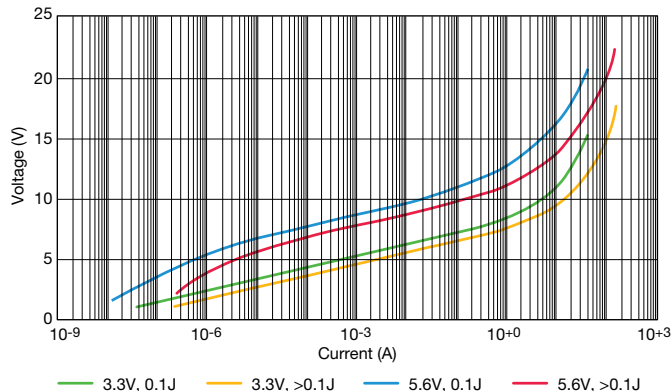

**VI Curves - 9V, 12V, and 14V Products**

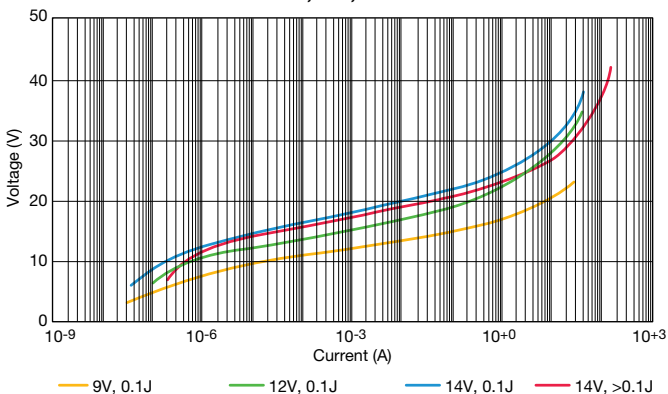

**VI Curves - 18V and 26V Products**

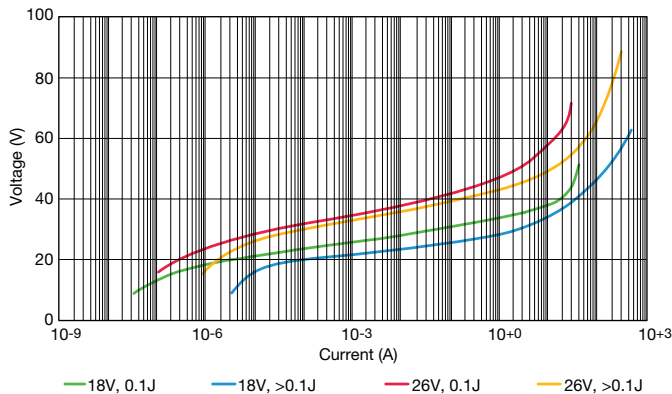

**VI Curves - 30V, 48V, and 60V Products**

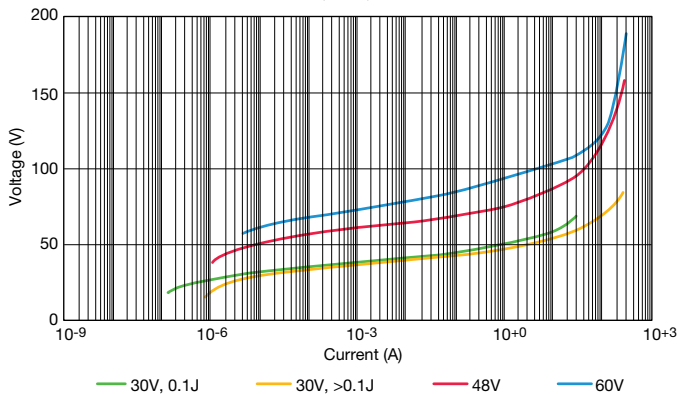

**VI Curve - 85V Product**

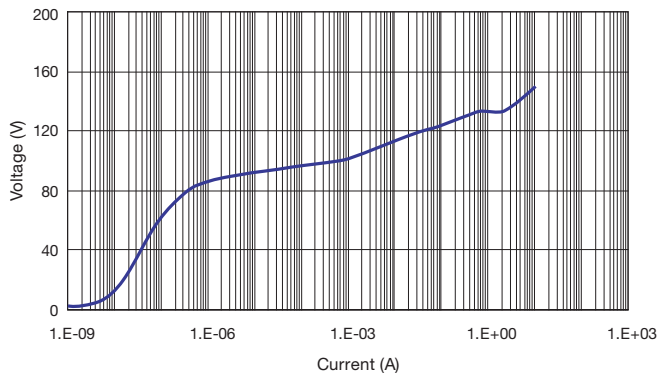

**TYPICAL PERFORMANCE CURVES (0603, 0805, 1206 & 1210 CHIP SIZES)**

TYPICAL PULSE RATING CURVE  
 3.3V MULTILAYER TRANSGUARD®

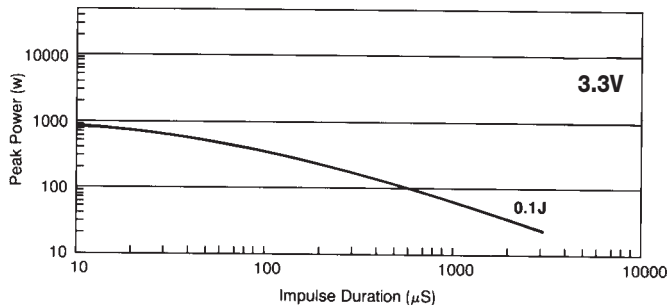

TYPICAL PULSE RATING CURVE  
 26V MULTILAYER TRANSGUARD®

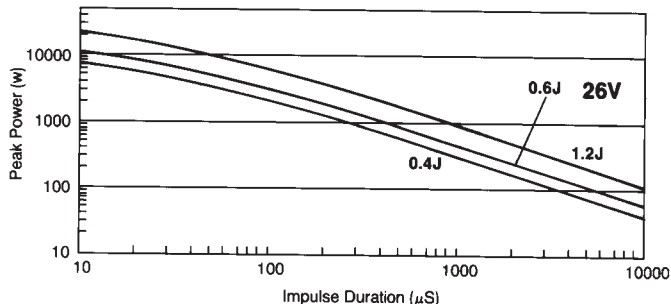

TYPICAL PULSE RATING CURVE  
 5.6V MULTILAYER TRANSGUARD®

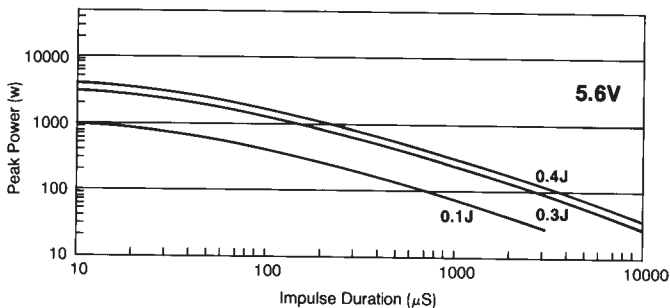

TYPICAL PULSE RATING CURVE  
 30V MULTILAYER TRANSGUARD®

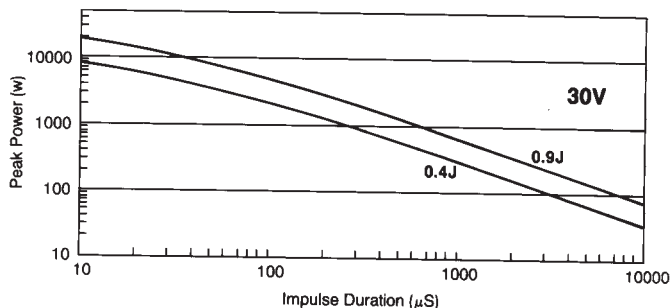

TYPICAL PULSE RATING CURVE  
 14V MULTILAYER TRANSGUARD®

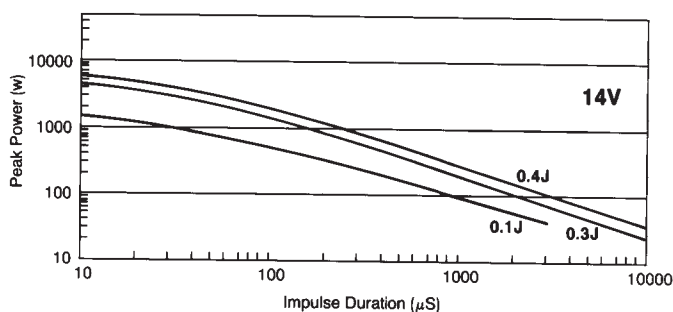

TYPICAL PULSE RATING CURVE  
 48V MULTILAYER TRANSGUARD®

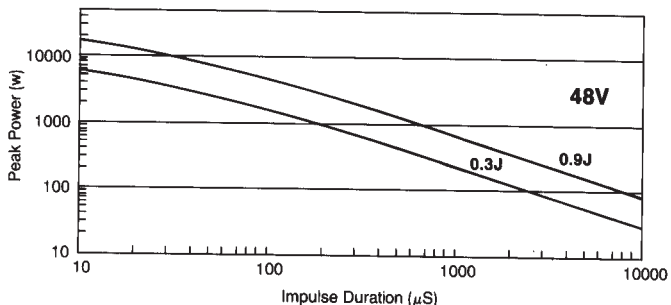

TYPICAL PULSE RATING CURVE  
 18V MULTILAYER TRANSGUARD®

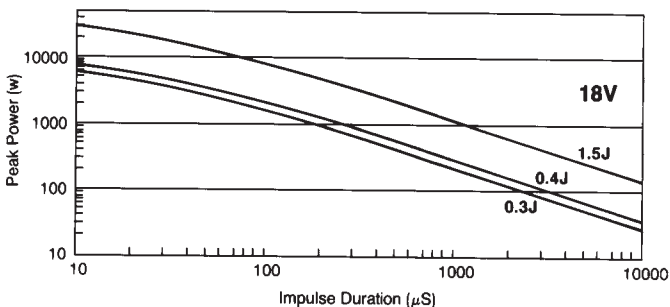

TYPICAL PULSE RATING CURVE  
 60V MULTILAYER TRANSGUARD®

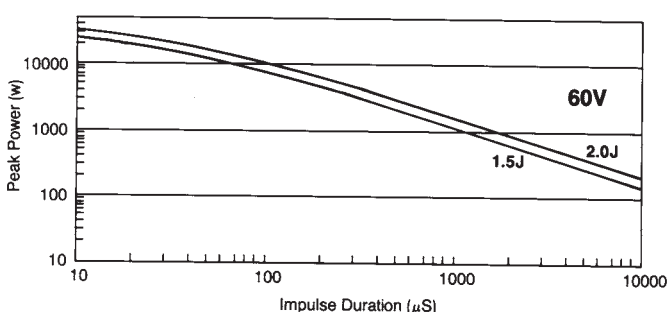



### TYPICAL PERFORMANCE CURVES (0603, 0805, 1206 & 1210 CHIP SIZES)

#### TEMPERATURE CHARACTERISTICS

TransGuard® suppressors are designed to operate over the full temperature range from -55°C to +125°C. This operating temperature range is for both surface mount and axial leaded products.

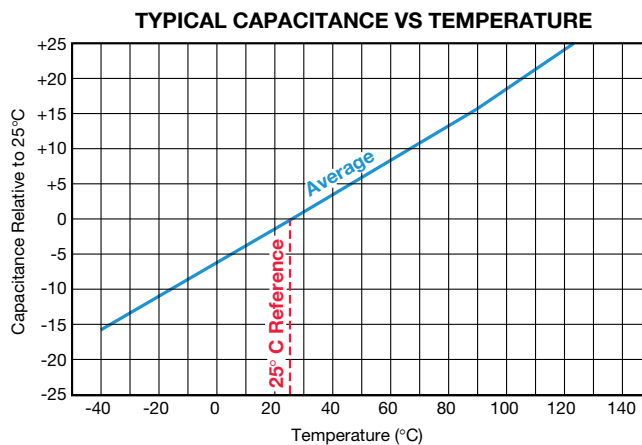
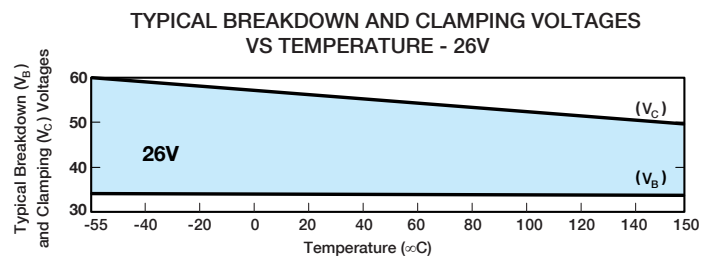
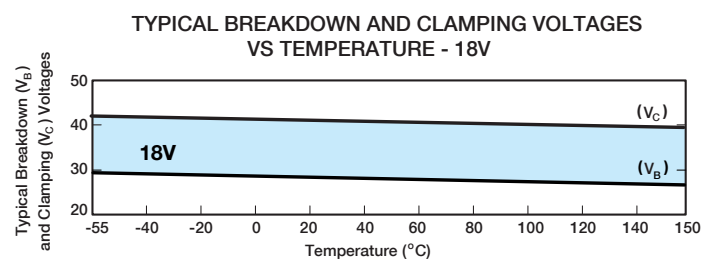
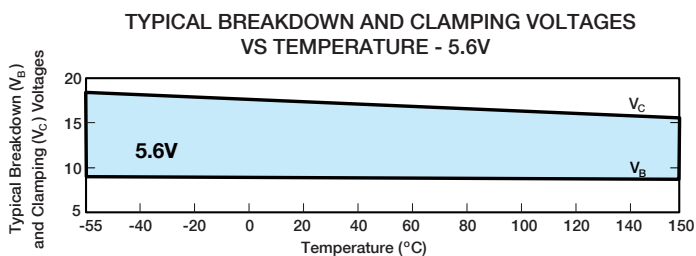
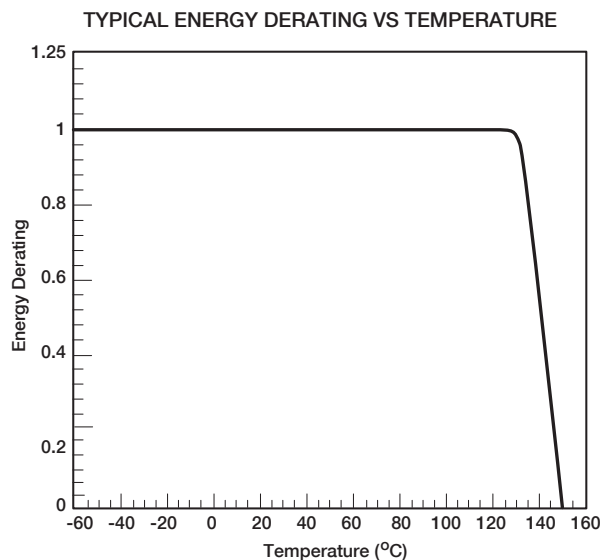
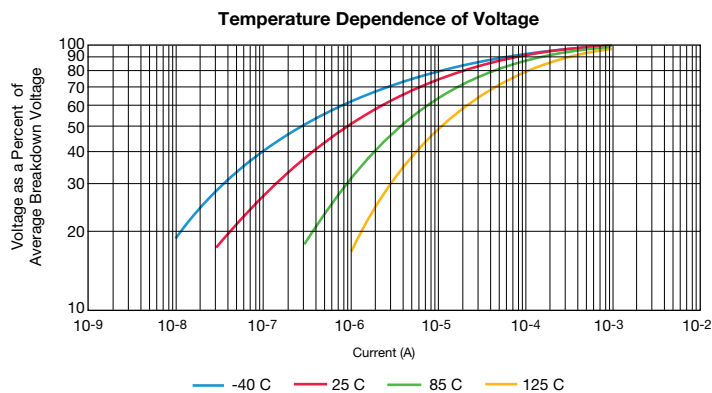

**TYPICAL PERFORMANCE CURVES (0603, 0805, 1206 & 1210 CHIP SIZES)**  
**PULSE DEGRADATION**

Traditionally varistors have suffered degradation of electrical performance with repeated high current pulses resulting in decreased breakdown voltage and increased leakage current. It has been suggested that irregular intergranular boundaries and bulk material result in restricted current paths and other non-Schottky barrier paralleled conduction paths in the ceramic. Repeated pulsing of both 5.6 and 14V TransGuard® transient voltage

suppressors with 150 Amp peak 8 x 20µS waveforms shows negligible degradation in breakdown voltage and minimal increases in leakage current. The plots of typical breakdown voltage vs number of 150A pulses are shown below.

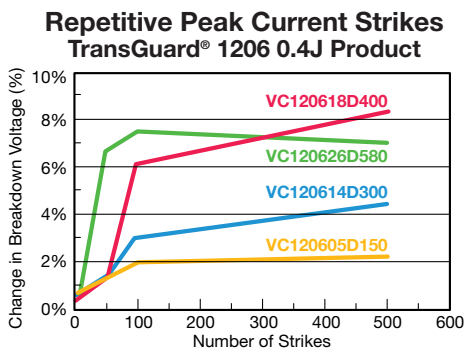

Figure 1

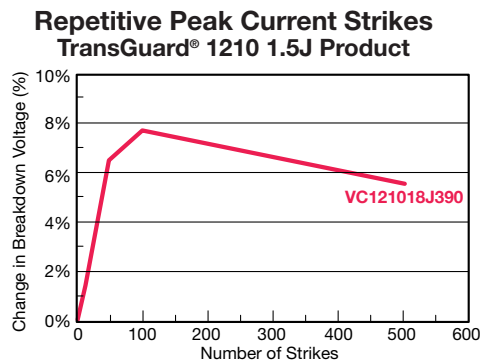

Figure 3

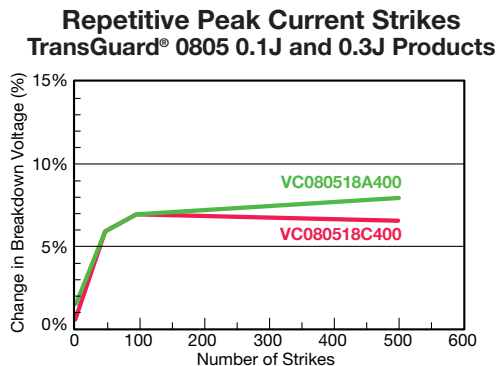

Figure 2

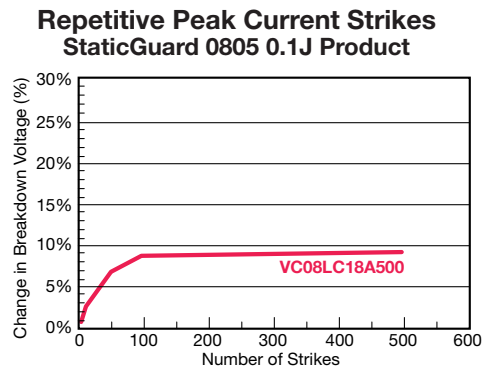
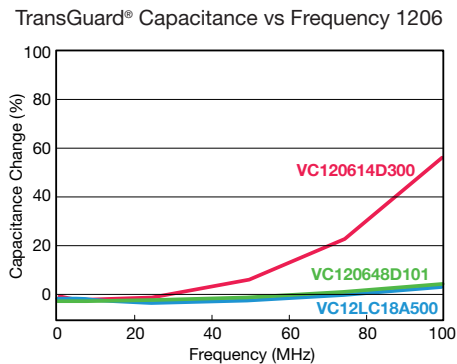
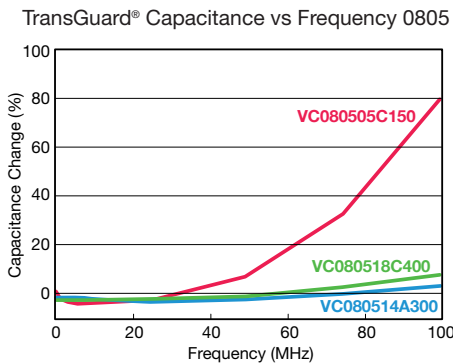
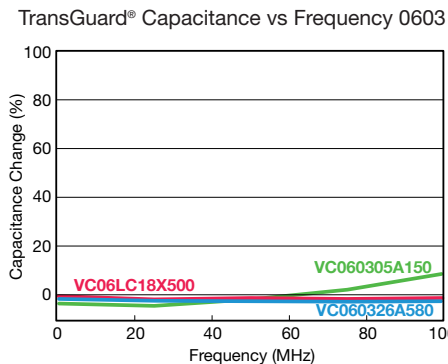

Figure 4

**CAPACITANCE/FREQUENCY CHARACTERISTICS**



# TransGuard® Automotive Series

## Multilayer Varistors for Automotive Applications

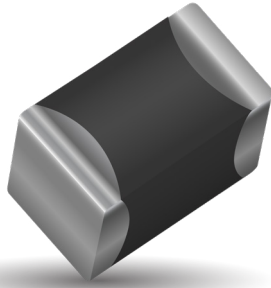

### GENERAL DESCRIPTION

The TransGuard Automotive Series are zinc oxide (ZnO) based ceramic semiconductor devices with non-linear, bi-directional voltage-current characteristics.

They have the advantage of offering bi-directional overvoltage protection as well as EMI/RFI attenuation in a single SMT package. The Automotive Series high current and high energy handling capability make them well suited for protection against automotive related transients.

AVX VG series parts (large case size, high energy) are glass encapsulated. These parts provide the same high reliability as traditional VC series parts. The glass encapsulation provides also enhanced resistance against harsh environment or process such as acids, salts, chlorite flux.

Operating Temperature: -55°C to +125°C

### FEATURES

- High Reliability
- High Energy Absorption (Load Dump)
- High Current Handling
- AEC Q200 Qualified
- Bi-Directional protection
- EMI/RFI attenuation
- Multi-strike capability
- Sub 1nS response to ESD strike

### APPLICATIONS

- Internal Combustion Engine (ICE) Vehicles
- Hybrid Electric Vehicles (HEV)
- Plug-in Hybrid Electric Vehicles (PHEV)
- Commercial Vehicles
  - CAN, LIN, FLEXRAY based modules
  - Sensors
  - Module load dump protection
  - Motor/inductive load transient suppression



### HOW TO ORDER

VC	AS	1206	18	D	400	R	P			
Varistor Chip	Automotive Series	Case Size	Working Voltage	Energy Rating	Clamping Voltage	Package	Termination			
VC = Varistor Chip VG = Varistor Glass Encapsulated Chip		0402 0603 0805 1206 1210 1812 2220 3220	03 = 3.3Vdc 05 = 5.6Vdc 09 = 9Vdc 12 = 12Vdc 14 = 14Vdc 16 = 16Vdc 18 = 18Vdc 22 = 22Vdc 26 = 26Vdc 30 = 30Vdc	31 = 31Vdc 34 = 34Vdc 38 = 38Vdc 42 = 42Vdc 45 = 45Vdc 48 = 48Vdc 56 = 56Vdc 60 = 60Vdc 65 = 65Vdc 85 = 85Vdc	A = 0.1J B = 0.2J C = 0.3J D = 0.4J E = 0.5J F = 0.7J H = 1.2J J = 1.5J K = 0.6J L = 0.8J	S = 1.9-2.0J X = 0.05J M = 1J N = 1.1J U = 4.0-5.0J P = 2.5-3.7J Y = 6.5-12J Z = 13J	140 = 14V 150 = 18V 220 = 22V 250 = 27V 300 = 32V 380 = 38V 390 = 42V 400 = 42V 440 = 44V 490 = 49V 540 = 54V 570 = 57V	580 = 60V 620 = 67V 650 = 67V 770 = 77V 800 = 80V 900 = 90V 101 = 100V 111 = 110V 131 = 135V 151 = 150V	D = 7" (1000)* R = 7" (4000)* T = 13" (10,000)* W = 7" (10,000)** 0402 only  *Not available for 0402 **Only available for 0402	P = Ni/Sn plated

# TransGuard® Automotive Series

## Multilayer Varistors for Automotive Applications



### ELECTRICAL CHARACTERISTICS

AVX PN	V <sub>w</sub> (DC)	V <sub>w</sub> (AC)	V <sub>B</sub>	V <sub>C</sub>	I <sub>VC</sub>	I <sub>L</sub>	E <sub>T</sub>	E <sub>LD</sub>	I <sub>P</sub>	Cap	Freq	V <sub>Jump</sub>	P <sub>Diss. Max</sub>
	Vdc	Vac	V	V	A	µA	J	J	A	pF	V	W	
VCAS060303A140	3.3	2.3	6.0±20%	14	1	50	0.1	-	30	1450	K	-	0.002
VCAS080503A140	3.3	2.3	6.0±20%	14	1	50	0.1	-	40	1000	K	-	0.002
VCAS080503C140	3.3	2.3	6.0±20%	14	1	50	0.3	-	120	4500	K	-	0.006
VCAS120603A140	3.3	2.3	6.0±20%	14	1	50	0.1	-	40	1500	K	-	0.002
VCAS120603D140	3.3	2.3	6.0±20%	14	1	50	0.4	-	150	4000	K	-	0.009
VCAS040205X150__	5.6	4.0	8.5±20%	18	1	35	0.05	-	20	175	M	-	0.001
VCAS060305A150__	5.6	4.0	8.5±20%	18	1	35	0.1	-	30	750	K	-	0.001
VCAS080505A150__	5.6	4.0	8.5±20%	18	1	35	0.1	-	40	1100	K	-	0.001
VCAS080505C150__	5.6	4.0	8.5±20%	18	1	35	0.3	-	120	3000	K	-	0.005
VCAS120605A150__	5.6	4.0	8.5±20%	18	1	35	0.1	-	40	1200	K	-	0.002
VCAS120605D150__	5.6	4.0	8.5±20%	18	1	35	0.4	-	150	3000	K	-	0.008
VCAS040209X200__	9	6.4	12.7±15%	22	1	25	0.05	-	20	175	M	-	0.001
VCAS060309A200__	9	6.4	12.7±15%	22	1	25	0.1	-	30	550	K	-	0.002
VCAS080509A200__	9	6.4	12.7±15%	22	1	25	0.1	-	40	750	K	-	0.002
VCAS080512A250__	12	8.5	16±15%	27	1	25	0.1	-	40	525	K	-	0.002
VCAS040214X300__	14	10	18.5±12%	32	1	15	0.05	-	20	85	K	16	0.001
VCAS060314A300__	14	10	18.5±12%	32	1	15	0.1	-	30	350	K	16	0.002
VCAS080514A300__	14	10	18.5±12%	32	1	15	0.1	-	40	325	K	16	0.002
VCAS080514C300__	14	10	18.5±12%	32	1	15	0.3	-	120	900	K	20	0.006
VCAS120614A300__	14	10	18.5±12%	32	1	15	0.1	-	40	600	K	20	0.002
VCAS120614D300__	14	10	18.5±12%	32	1	15	0.4	-	150	1050	K	20	0.008
VCAS060316B400__	16	11	25.5±10%	42	1	10	0.2	0.25	30	150	K	27.5	0.003
VCAS120616K380__	16	11	25.5±10%	38	1	10	0.6	1.5	200	930	K	27.5	0.010
VCAS121016J390__	16	11	25.5±10%	42	5	10	1.6	3	500	3100	K	27.5	0.030
VGAS121016S390	16	14	24.5±10%	40	2.5	15	2	5	500	3000	K	27.5	0.01
VGAS181216P390	16	11	24.5±10%	40	5	15	2.9	10	1000	7000	K	27.5	0.07
VGAS222016Y390	16	11	24.5±10%	40	10	15	10.2	35	1500	20000	K	27.5	0.08
VGAS181216P400__	16	11	24.5±10%	42	5	10	2.9	10	1000	5000	K	27.5	0.070
VGAS222016Y400	16	11	24.5±10%	42	10	10	7.2	25	1500	13000	K	25.5	0.100
VCAS040218X400__	18	13	25.5±10%	42	1	10	0.05	0.05	20	65	M	27.5	0.001
VCAS060318A400__	18	13	25.5±10%	42	1	10	0.1	0.25	30	150	K	27.5	0.003
VCAS080518A400__	18	13	25.5±10%	42	1	10	0.1	0.1	30	225	K	27.5	0.002
VCAS080518C400__	18	13	25.5±10%	42	1	10	0.3	1	120	550	K	27.5	0.007
VCAS120618A400__	18	13	25.5±10%	42	1	10	0.1	0.5	30	350	K	27.5	0.002
VCAS120618D400__	18	13	25.5±10%	42	1	10	0.4	1.5	150	900	K	27.5	0.008
VCAS120618E380__	18	13	25.5±10%	38	1	10	0.5	1.5	200	930	K	27.5	0.010
VCAS121018J390__	18	13	25.5±10%	42	5	10	1.6	3	500	3100	K	27.5	0.030
VGAS181218P440	18	14	27.5±10%	44	5	15	2.9	6	800	5000	K	27.5	0.05
VGAS222022Y490	22	17	30±10%	49	10	15	6.8	25	1200	12000	K	27.5	0.03
VCAS060326A580__	26	18	34.5±10%	60	1	10	0.1	0.1	30	155	K	27.5	0.002
VCAS080526A580__	26	18	34.5±10%	60	1	10	0.1	0.15	30	120	K	27.5	0.002
VCAS080526C580__	26	18	34.5±10%	60	1	10	0.3	0.5	100	250	K	27.5	0.006
VCAS120626D580__	26	18	34.5±10%	60	1	10	0.4	1	120	500	K	27.5	0.008
VCAS120626F540__	26	18	33.0±10%	54	1	15	0.7	1.5	200	600	K	27.5	0.008
VCAS121026H560__	26	18	34.5±10%	60	5	10	1.2	3	300	2150	K	27.5	0.018
VGAS181226P570	26	23	35.0±10%	57	5	15	2.5	8	600	3000	K	30	0.015
VGAS222026Y570	26	23	35±10%	57	10	15	6.8	25	1100	7000	K	30	0.030
VGAS322026Z570	26	23	35±10%	57	10	15	13	50	1800	15000	K	30	0.04
VCAS060330A650__	30	21	41.0±10%	67	1	10	0.1	0.15	30	125	K	29	0.002
VCAS080530A650__	30	21	41.0±10%	67	1	10	0.1	0.15	30	90	M	29	0.002
VCAS080530C650__	30	21	41.0±10%	67	1	10	0.3	0.5	80	250	K	29	0.005
VCAS120630D650__	30	21	41.0±10%	67	1	10	0.4	1	120	400	K	29	0.008
VCAS121030H620__	30	21	41.0±10%	67	5	10	1.2	3	280	1850	K	30	0.018
VCAS121030S620__	30	21	41.0±10%	67	5	10	1.9	3	300	1500	K	29	0.038
VCAS080531C650__	31	25	39.0±10%	65	1	10	0.3	0.5	80	250	K	29	0.005
VCAS120631M650__	31	25	39.0±10%	65	1	15	1	1.5	200	500	K	29	0.008
VGAS121031R650	31	25	39±10%	65	2.5	15	1.7	4.5	300	1200	K	30	0.05
VGAS181231P650	31	25	39.0±10%	65	5	15	3.7	8	800	2600	K	30	0.06
VGAS222031Y650	31	25	39±10%	65	10	15	9.6	23	1200	6100	K	30	0.03
VCAS120634N770__	34	30	47.0±10%	77	1	15	1.1	1.5	200	400	K	48	0.008
VGAS121034S770__	34	30	47.0±10%	77	2.5	15	2	3.0	400	1000	K	48	0.040
VGAS181234U770__	34	30	47.0±10%	77	5	15	5	6.1	800	1500	K	48	0.080



The Important Information/Disclaimer is incorporated in the catalog where these specifications came from or available online at [www.avx.com/disclaimer/](http://www.avx.com/disclaimer/) by reference and should be reviewed in full before placing any order.

# TransGuard® Automotive Series

## Multilayer Varistors for Automotive Applications



### ELECTRICAL CHARACTERISTICS

AVX PN	V <sub>w</sub> (DC)	V <sub>w</sub> (AC)	V <sub>B</sub>	V <sub>c</sub>	I <sub>vc</sub>	I <sub>L</sub>	E <sub>T</sub>	E <sub>LD</sub>	I <sub>p</sub>	Cap	Freq	V <sub>Jump</sub>	P <sub>Diss. Max</sub>
	Vdc	Vac	V	V	A	µA	J	J	A	pF	V	W	
VGAS222034Y770	34	30	47.0±10%	77	10	15	12	25	2000	6300	K	48	0.240
VGAS322034Z770	34	30	47±10%	77	10	15	13	50	2000	18000	K	48	0.26
VCAS080538C770 __	38	30	47.0±10%	77	1	10	0.3	-	80	200	K	48	0.006
VCAS120642L800 __	42	32	51.0±10%	80	1	15	0.8	-	180	600	K	48	0.016
VCAS120642K900	42	32	56±10%	90	1	15	0.6	-	200	260	K	48	0.012
VGAS181242U900	42	35	56.0±10%	90	5	15	4.0	6	500	1200	K	48	0.015
VGAS222042Y900	42	37	56±10%	90	10	15	12	24	1000	5000	K	48	0.06
VCAS120645K900	45	35	56±10%	90	1	25	0.6	-	200	260	K	48	0.012N
VCAS120648D101 __	48	34	62.0±10%	100	1	10	0.4	-	100	225	K	48	0.008
VCAS121048H101 __	48	34	62.0±10%	100	1	10	1.2	-	250	500	K	48	0.022
VCAS120656F111 __	56	40	68.0±10%	110	1	15	0.7	-	100	180	K	48	0.014
VGAS181256U111	56	40	68±10%	110	5	15	4.8	-	500	1100	K	48	0.04
VCAS120660M131 __	60	50	82.0±10%	135	1	15	1	-	150	250	K	48	0.008
VCAS121060J121	60	42	76±10%	120	5	10	1.5	-	250	400	K	48	0.03
VGAS121065P131	65	50	82±10%	135	2.5	15	2.7	-	350	600	K	48	0.05
VGAS181265U131	65	50	82±10%	135	5	15	4.5	-	400	800	K	48	0.03
VGAS222065Y131	65	50	82±10%	135	10	15	6.5	-	1100	3000	K	48	0.06
VCAS121085S151 __	85	60	100.0±10%	150	1	35	2	-	250	275	K	48	0.040
VGAS181285U161	85	60	100±10%	165	5	15	4.5	-	400	500	K	48	0.04

- V<sub>w</sub> (DC) DC Working Voltage (V)
- V<sub>w</sub> (AC) AC Working Voltage (V)
- V<sub>B</sub> Typical Breakdown Voltage (V @ 1mA<sub>DC</sub>)
- V<sub>c</sub> Clamping Voltage [V @ I<sub>vc</sub>]
- I<sub>vc</sub> Test Current for V<sub>c</sub>
- I<sub>L</sub> Maximum Leakage Current at the working voltage, 25°C (µA)
- E<sub>T</sub> Transient Energy Rating (J, 10x1000µS)
- I<sub>p</sub> Peak Current Rating (A, 8x20µS)
- Cap Typical Capacitance (pF) @ frequency specified and 0.5 V<sub>RMS</sub>, 25°C
- V<sub>Jump</sub> Jump Start (V)
- P Power Dissipation (W)

### AUTOMOTIVE SERIES – LOAD DUMP TEST ACCORDING TO ISO DP7637 REV 2 PULSE 5

**Automotive Load Dump Pulse  
(According to ISO 7637 Pulse 5)**

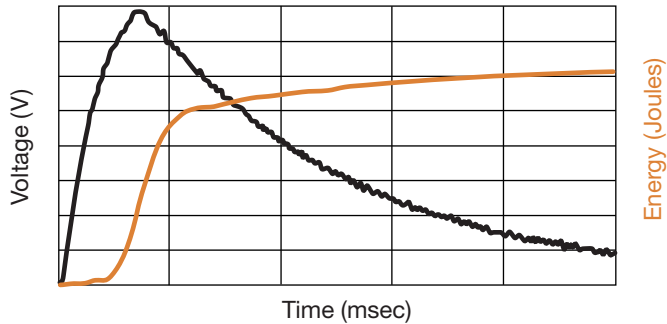

When using the test method indicated below, the amount of Energy dissipated by the varistor must not exceed the Load Dump Energy value specified in the product table.

### LOAD DUMP LIBRARY

#### TYPICAL MAX VZ VERSUS PULSE DURATION AND RI

##### 12V SYSTEMS

<b>VCAS060316B400</b>	<b>0.5Ω</b>	<b>1Ω</b>	<b>4Ω</b>
100ms	37	38	42
200ms	36	37	41
400ms	35	36	39
<b>VCAS120616K380</b>	<b>0.5Ω</b>	<b>1Ω</b>	<b>4Ω</b>
100ms	42	45	55
200ms	40	43	50
400ms	39	40	45
<b>VCAS121016J390</b>	<b>0.5Ω</b>	<b>1Ω</b>	<b>4Ω</b>
100ms	48	53	74
200ms	46	50	64
400ms	43	46	56
<b>VGAS181216P400</b>	<b>0.5Ω</b>	<b>1Ω</b>	<b>4Ω</b>
100ms	46	52	72
200ms	37	41	59
400ms	32	35	51
<b>VGAS222016Y400</b>	<b>0.5Ω</b>	<b>1Ω</b>	<b>4Ω</b>
100ms	53	60	77
200ms	50	55	73
400ms	47	50	66
<b>VCAS040218X400</b>	<b>0.5Ω</b>	<b>1Ω</b>	<b>4Ω</b>
100ms	38	39	40
200ms	37	37	38
400ms	34	35	36
<b>VCAS060318A400</b>	<b>0.5Ω</b>	<b>1Ω</b>	<b>4Ω</b>
100ms	37	38	42
200ms	36	37	41
400ms	35	36	39
<b>VCAS080518A400</b>	<b>0.5Ω</b>	<b>1Ω</b>	<b>4Ω</b>
100ms	37	39	40
200ms	35	38	39
400ms	33	37	38
<b>VCAS080518C400</b>	<b>0.5Ω</b>	<b>1Ω</b>	<b>4Ω</b>
100ms	40	41	48
200ms	39	40	45
400ms	38	39	42
<b>VCAS120618A400</b>	<b>0.5Ω</b>	<b>1Ω</b>	<b>4Ω</b>
100ms	43	45	55
200ms	41	43	48
400ms	40	41	45
<b>VCAS120618D400</b>	<b>0.5Ω</b>	<b>1Ω</b>	<b>4Ω</b>
100ms	42	45	55
200ms	40	42	50
400ms	39	40	45
<b>VCAS120618E380</b>	<b>0.5Ω</b>	<b>1Ω</b>	<b>4Ω</b>
100ms	42	45	55
200ms	40	43	50
400ms	39	40	45
<b>VCAS121018J390</b>	<b>0.5Ω</b>	<b>1Ω</b>	<b>4Ω</b>
100ms	48	53	74
200ms	46	50	64
400ms	43	46	56

##### 24V SYSTEMS

<b>VCAS060326A580</b>	<b>1Ω</b>	<b>4Ω</b>	<b>8Ω</b>
100ms	51	56	58
200ms	50	54	56
400ms	49	51	53
<b>VCAS080526A580</b>	<b>1Ω</b>	<b>4Ω</b>	<b>8Ω</b>
100ms	51	53	59
200ms	49	51	57
400ms	48	50	51
<b>VCAS080526C580</b>	<b>1Ω</b>	<b>4Ω</b>	<b>8Ω</b>
100ms	51	54	62
200ms	49	51	56
400ms	48	49	51
<b>VCAS120626D580</b>	<b>1Ω</b>	<b>4Ω</b>	<b>8Ω</b>
100ms	52	60	68
200ms	50	57	65
400ms	47	54	61
<b>VCAS121026H560</b>	<b>1Ω</b>	<b>4Ω</b>	<b>8Ω</b>
100ms	61	74	91
200ms	59	69	82
400ms	55	64	70
<b>VCAS060330A650</b>	<b>1Ω</b>	<b>4Ω</b>	<b>8Ω</b>
100ms	57	59	63
200ms	56	58	61
400ms	54	57	58
<b>VCAS080530A650</b>	<b>1Ω</b>	<b>4Ω</b>	<b>8Ω</b>
100ms	58	62	66
200ms	56	61	64
400ms	53	57	61
<b>VCAS080530C650</b>	<b>1Ω</b>	<b>4Ω</b>	<b>8Ω</b>
100ms	58	61	63
200ms	57	58	62
400ms	55	56	59
<b>VCAS120630D650</b>	<b>1Ω</b>	<b>4Ω</b>	<b>8Ω</b>
100ms	61	70	75
200ms	57	66	69
400ms	56	62	64
<b>VCAS121030H620</b>	<b>1Ω</b>	<b>4Ω</b>	<b>8Ω</b>
100ms	70	77	98
200ms	64	70	89
400ms	56	65	70
<b>VGAS181234U770</b>	<b>1Ω</b>	<b>4Ω</b>	<b>8Ω</b>
100ms	87	110	125
200ms	82	97	114
400ms	75	85	95
<b>VGAS222034Y770</b>	<b>1Ω</b>	<b>4Ω</b>	<b>8Ω</b>
100ms	100	125	165
200ms	91	115	155
400ms	84	104	120

# TransGuard® Automotive Series

## Multilayer Varistors for Automotive Applications

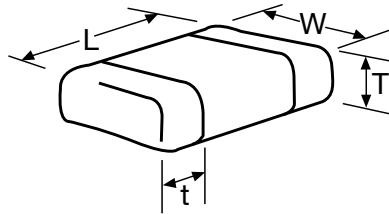

### DIMENSIONS: MM (INCHES)

AVX Style		0402	0603	0805	1206	1210	1812	2220	3220
(L) Length	mm (in.)	1.00±0.10 (0.040±0.004)	1.60±0.15 (0.063±0.006)	2.01±0.20 (0.079±0.008)	3.20±0.20 (0.126±0.008)	3.20±0.20 (0.126±0.008)	4.50±0.30 (0.177±0.012)	5.70±0.40 (0.224±0.016)	8.20±0.40 (0.323±0.016)
(W) Width	mm (in.)	0.50±0.10 (0.020±0.004)	0.80±0.15 (0.031±0.006)	1.25±0.20 (0.049±0.008)	1.60±0.20 (0.063±0.008)	2.49±0.20 (0.098±0.008)	3.20±0.30 (0.126±0.012)	5.00±0.40 (0.197±0.016)	5.00±0.40 (0.197±0.016)
(T) Max Thickness	mm (in.)	0.6 (0.024)	0.9 (0.035)	1.02 (0.040)	1.02 (0.040) 1.27 (0.050) <sup>1)</sup> 1.70 (0.067) <sup>2)</sup>	1.70 (0.067)	2.00 (0.080)	2.50 (0.098)	2.50 max. (0.098 max.)
(t) Land Length	mm (in.)	0.25±0.15 (0.010±0.006)	0.35±0.15 (0.014±0.006)	0.71 max. (0.028 max.)	0.94 max. (0.037 max.)	1.14 max. (0.045 max.)	1.00 max. (0.039 max.)	1.00 max. (0.039 max.)	1.30 max. (0.051 max.)

1) Applicable for: VCAS120618E380

2) Applicable for: VCAS120626F540, VCAS120631M650, VCAS120638N770, VCAS120642L800, VCAS120645K900, VCAS120656F111, VCAS120660M131

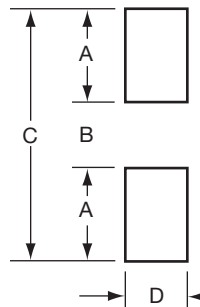

### SOLDERING PAD: MM (INCHES)

Pad Layout	0402	0603	0805	1206	1210	1812	2220	3220
A	1.61 (0.024)	0.89 (0.035)	1.02 (0.040)	1.02 (0.040)	1.02 (0.040)	1.00 (0.039)	1.00 (0.039)	2.21 (0.087)
B	1.51 (0.020)	0.76 (0.030)	1.02 (0.040)	2.03 (0.080)	2.03 (0.080)	3.60 (0.142)	4.60 (0.18)	5.79 (0.228)
C	1.70 (0.067)	2.54 (0.100)	3.05 (0.120)	4.06 (0.160)	4.06 (0.160)	5.60 (0.220)	6.60 (0.26)	10.21 (0.402)
D	1.51 (0.020)	0.76 (0.030)	1.27 (0.050)	1.65 (0.065)	2.54 (0.100)	3.00 (0.118)	5.00 (0.20)	5.50 (0.217)

**FORWARD TRANSMISSION CHARACTERISTICS (S21)**

**0603 Case Size**

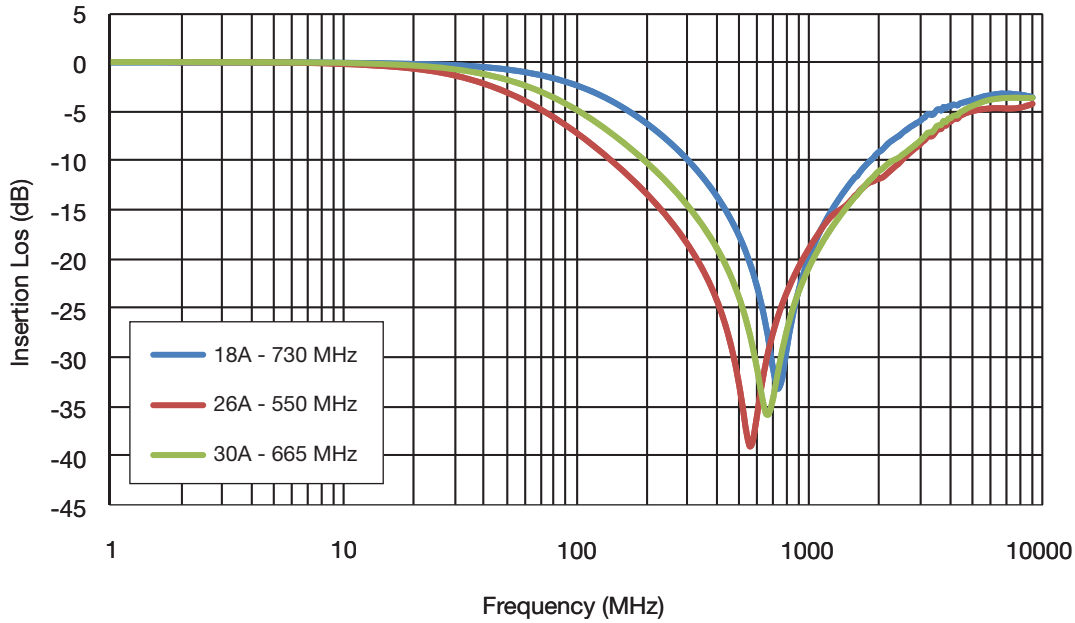

**0805 Case Size**

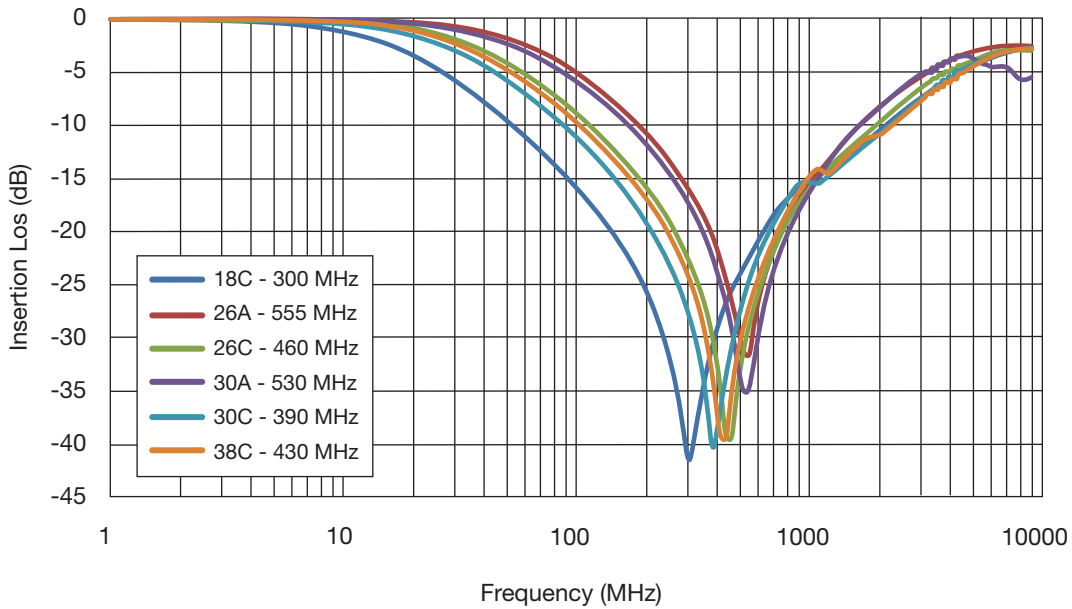



**FORWARD TRANSMISSION CHARACTERISTICS (S21)**

**1206 Case Size**

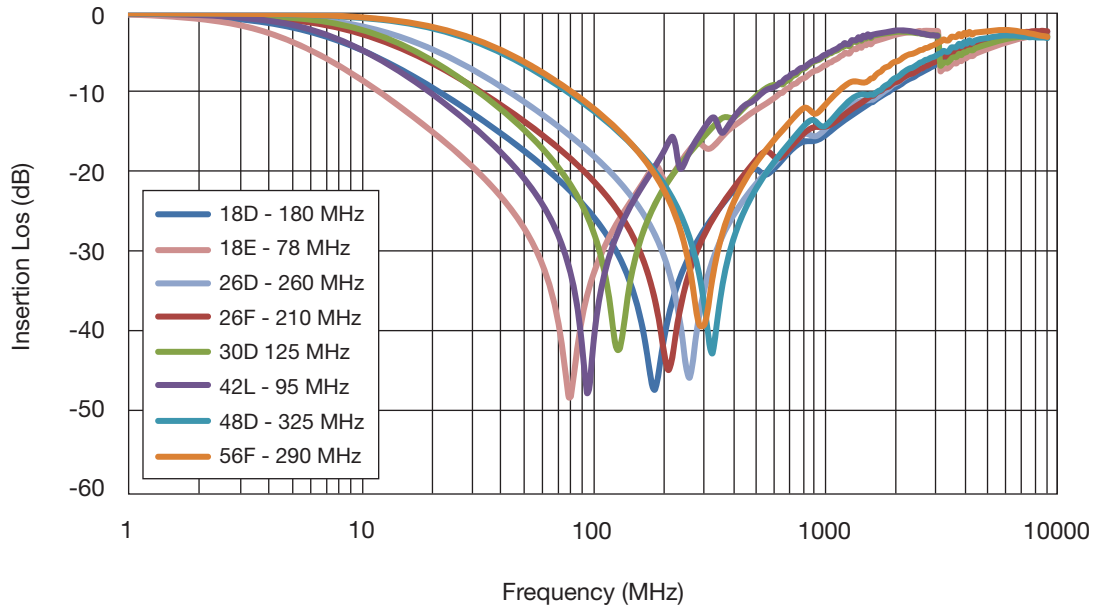

**1210 Case Size**

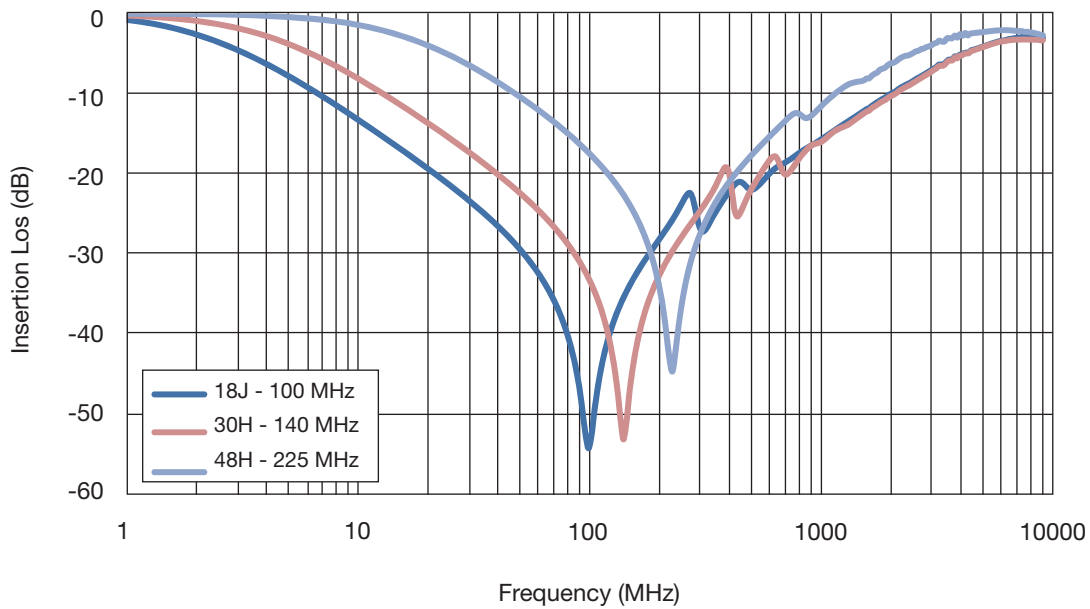

**V-I CHARACTERISTICS**

**0603 Case Size**

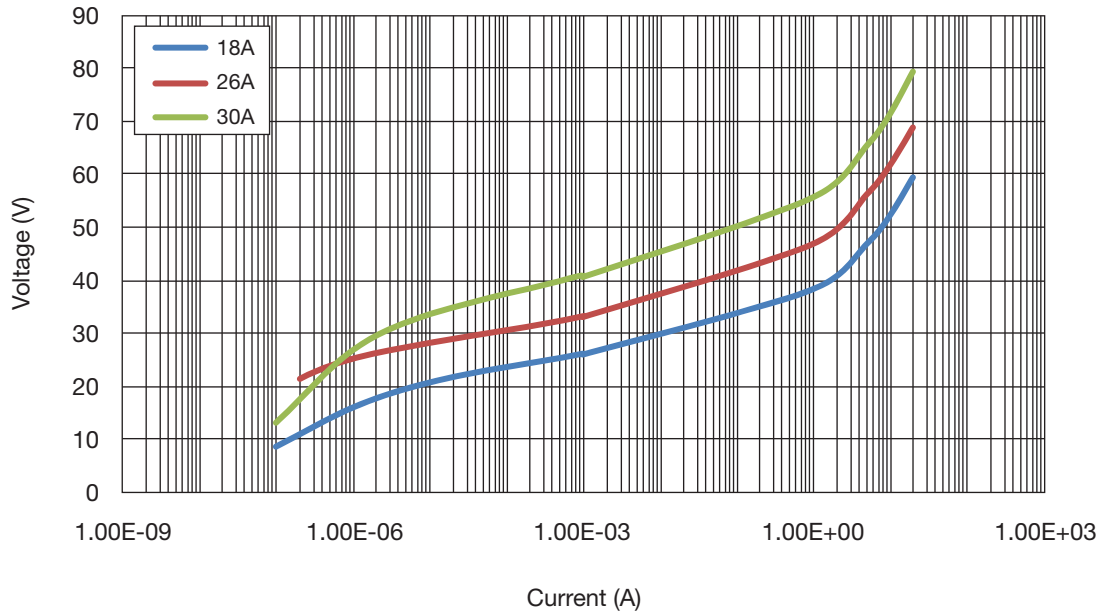

**0805 Case Size**

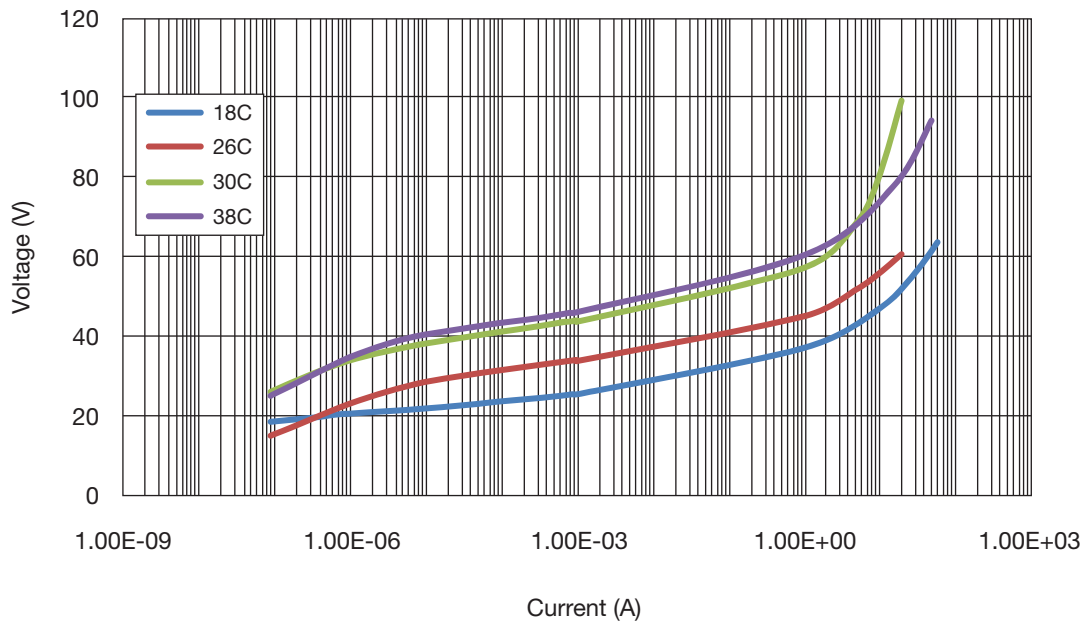

**FORWARD TRANSMISSION CHARACTERISTICS (S21)**

**1206 Case Size**

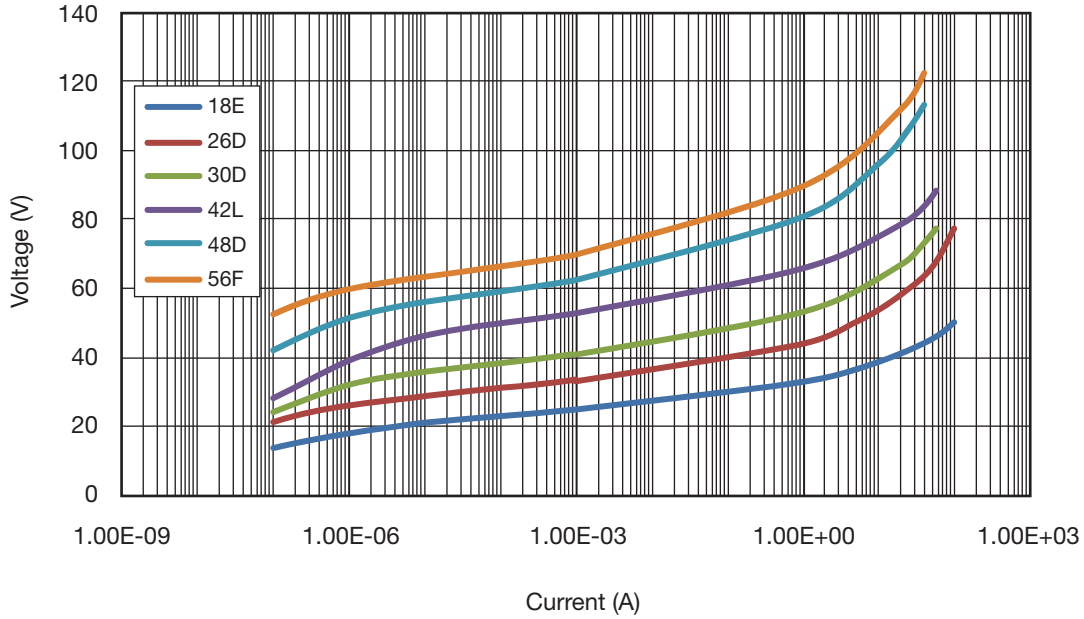

**1210 Case Size**

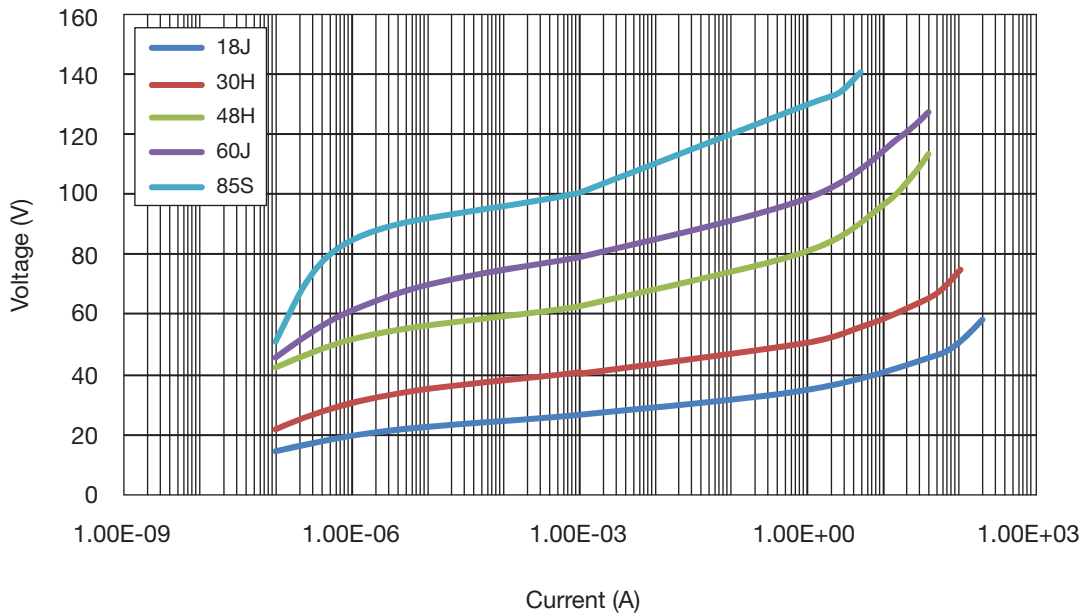

**ESD V-I CHARACTERISTICS**

**8 kV ESD Vc  
 (150pF/300ohm IEC Network)**

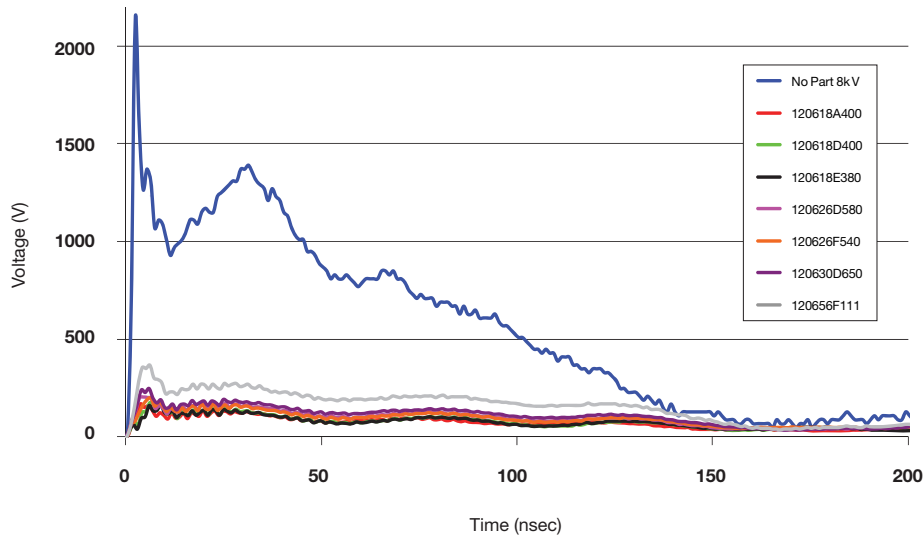

**TYPICAL VOLTAGE AT 8 KV PULSE**

8kV Pulse	Peak Voltage (V)	30ns Voltage (V)	100ns Voltage (V)
No Part (No Suppression)	2130	1370	517
120618A400	171	123	65
120618D400	177	133	66
120618E380	161	121	63
120626D580	203	155	88
102626F540	201	159	84
120630D650	249	177	106
120656F111	366	262	169

**ESD 8 kV IEC 61000-4-2 150pF / 330Ω Resistor  
 VC060318A400**

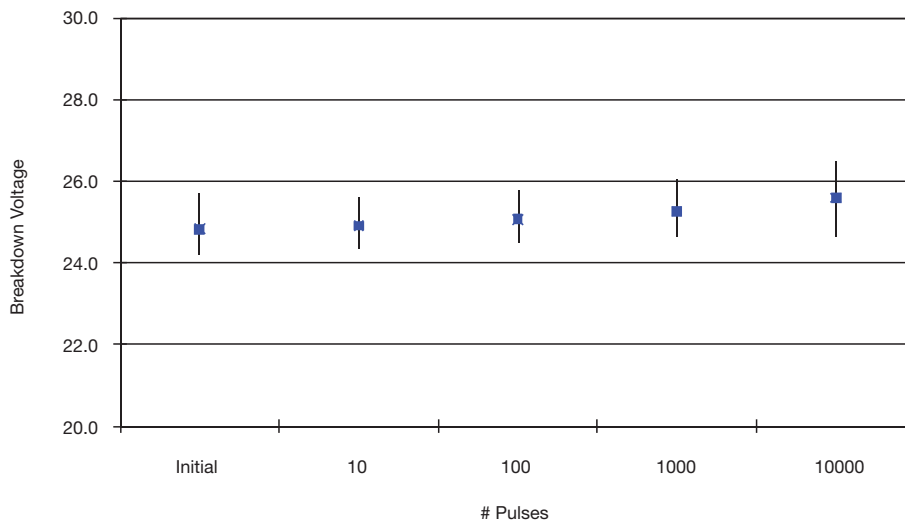

# Low Clamp Automotive TransGuard®

## Multilayer Varistors with Low Clamping to Working Voltage Ratio

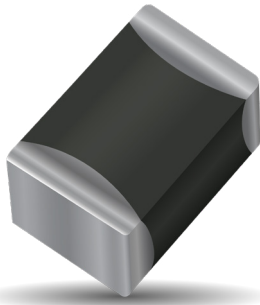

### GENERAL DESCRIPTION

AVX Low Clamping Automotive TransGuard® Multilayer Varistors are designed for applications where lower clamping to working voltage ratio is required. Parts are suitable for automotive, industrial and general applications. Parts are AEC-Q200 qualified.

They offer bi-directional ESD overvoltage protection as well as EMI/RFI attenuation in a single SMT package. This allows designers the ability to combine the circuit protection and EMI/RFI attenuation function into a single highly reliable device.

Compared to standard varistors, low clamp varistors exhibit lower breakdown and clamping to working voltage ratio and provide enhanced protection for components with higher sensitivity to overvoltage.

Available in 0603 to 1210 case size, 16-30 Vdc working voltage, energy rating 0.1 - 1.6J, load dump energy 0.7 - 3J, peak current 50 - 500A and capacitance 275 - 5000pF. Operating temperature range is -55°C to +125°C. Parts offer excellent lead free solderability thanks to Ni Barrier/100% Sn termination.

### GENERAL CHARACTERISTICS

- Operating Temp.: -55 to +125°C
- Working Voltage: 16-30 Vdc
- Case Size: 0603 - 1210

### FEATURES & BENEFITS

- AEC-Q200 Qualified
- Low Clamping to Working Voltage ratio
- EMI/RFI attenuation

### APPLICATIONS

- Infotainment
- ECU
- Displays
- Microcontrollers
- Low  $V_C$  to  $V_W$  ratio requirements

### HOW TO ORDER

**VL**  
Varistor Low Clamp

**AS**  
Automotive Series

**0603**  
Case Size  
0603  
0805  
1206  
1210

**16**  
Working Voltage  
16 = 16Vdc  
30 = 30Vdc

**A**  
Energy Rating  
A = 0.1J  
C = 0.3J  
D = 0.4J  
E = 0.5J  
J = 1.6J

**350**  
Clamping Voltage  
350 = 35V  
570 = 57V

**R**  
Package  
D = 7" (1,000)  
R = 7" (4,000)  
T = 13" (10,000)

**P**  
Termination  
P = Ni/Sn plated



### DIMENSIONS

Size (EIA)	Length (L)	Width (W)	Max Thickness (T)	Land Length (t)
0603	1.60±0.15 (0.063±0.006)	0.80±0.15 (0.031±0.006)	0.90 (0.035)	0.35±0.15 (0.014±0.006)
0805	2.01±0.20 (0.079±0.008)	1.25±0.20 (0.049±0.008)	1.02 (0.040)	0.71 max. (0.028 max.)
1206	3.20±0.20 (0.126±0.008)	1.60±0.20 (0.063±0.008)	1.02 (0.040)	0.94 max. (0.037 max.)
1210	3.20±0.20 (0.126±0.008)	2.49±0.20 (0.098±0.008)	1.70 (0.067)	1.14 max. (0.045 max.)

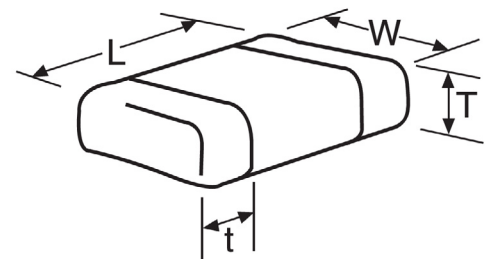

# Low Clamp Automotive TransGuard®

## Multilayer Varistors with Low Clamping to Working Voltage Ratio



### ELECTRICAL CHARACTERISTICS

AVX PM	V <sub>w</sub> (DC)	V <sub>w</sub> (AC)	V <sub>B</sub>	V <sub>C</sub>	V <sub>CTYP</sub>	I <sub>VC</sub>	I <sub>L</sub>	E <sub>T</sub>	E <sub>LD</sub>	I <sub>P</sub>	Cap	V <sub>Jump</sub>	P <sub>Diss. Max</sub>
	Vdc	Vac	V	V	V	A	μA	J	J	A	pF	V	W
VLAS060316A350	16	11	19.5+12%	35	30	1	10	0.1	-	50	400	20	0.003
VLAS080516C350	16	11	19.5+12%	35	30	1	10	0.3	0.7	120	900	20	0.006
VLAS120616E350	16	11	19.5+12%	35	30	1	10	0.5	1.3	200	1400	20	0.010
VLAS121016J350	16	11	19.5+12%	35	30	2.5	10	1.6	3	500	5000	20	0.030
VLAS080530D570	30	21	34+13%	57	50	1	15	0.4	0.6	125	275	29	0.008
VLAS060334B650	34	30	39+13%	65	60	1	10	0.2	0.25	50	90	29	0.004
VLAS080534C650	34	30	39+13%	65	60	1	10	0.3	1	80	275	29	0.006

- V<sub>w</sub>(DC) DC Working Voltage [V]
- V<sub>w</sub>(AC) AC Working Voltage [V]
- V<sub>B</sub> Breakdown Voltage [V @ 1mADC]
- V<sub>C</sub> Clamping Voltage [V @ I<sub>VC</sub>]
- V<sub>CTYP</sub> Typical Clamping Voltage [V @ I<sub>VC</sub>]
- I<sub>VC</sub> Test Current for VC
- I<sub>L</sub> Maximum leakage current at the working voltage, 25°C [μA]
- E<sub>T</sub> Transient Energy Rating [J, 10x1000μS]
- I<sub>P</sub> Peak Current Rating [A, 8x20μS]
- Cap Typical capacitance [pF] @ 1kHz and 0.5VRMS, 25°C
- V<sub>Jump</sub> Jump Start (V)
- P<sub>Diss Max</sub> Max Power Dissipation (W)

### V-I CHARACTERISTICS

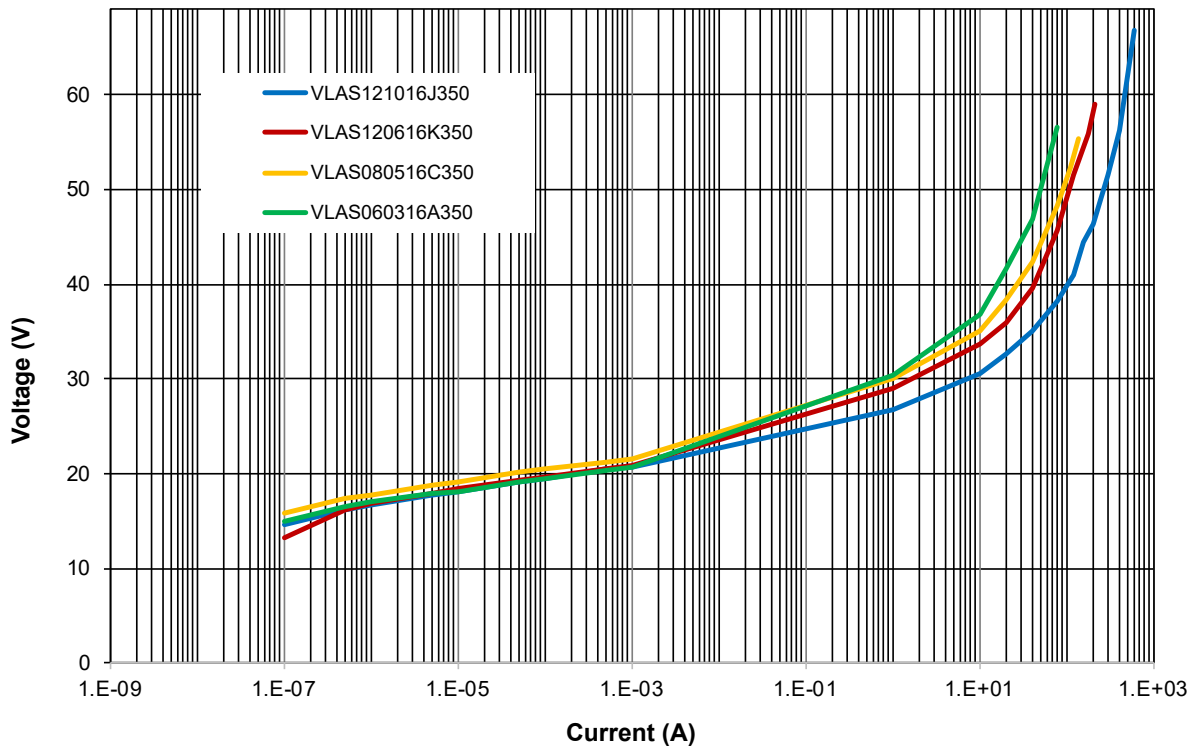

### FORWARD TRANSMISSION CHARACTERISTICS (S21)

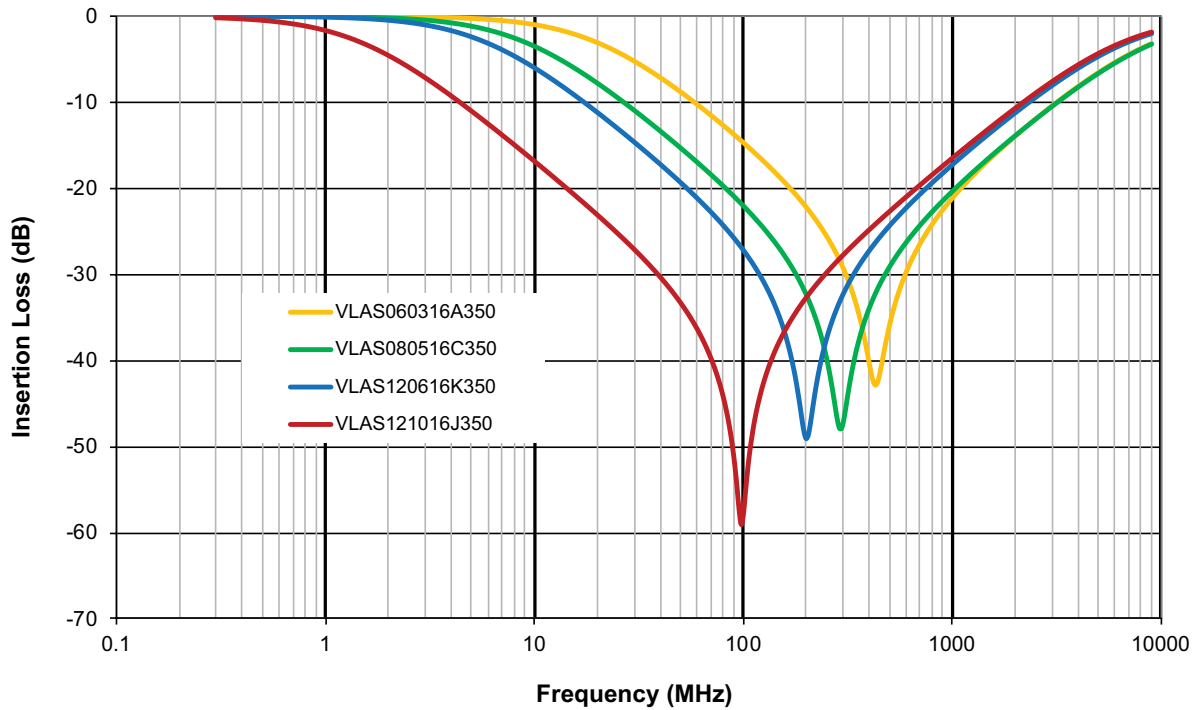

# StaticGuard

## Multilayer Ceramic Transient Voltage Suppressors ESD Protection for CMOS, Bi Polar and SiGe Based Systems

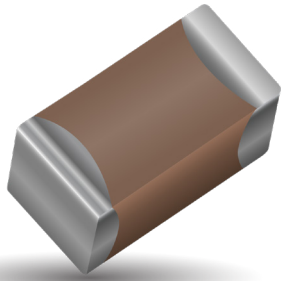

### GENERAL DESCRIPTION

The StaticGuard Series are low capacitance versions of the TransGuard and are designed for general ESD protection of CMOS, Bi-Polar, and SiGe based systems. The low capacitance makes these products suitable for use in high speed data transmission lines.

### GENERAL CHARACTERISTICS

- Operating Temperature: -55°C to 125°C
- Working Voltage:  $\leq 18\text{Vdc}$
- Case Size: 0402, 0603, 0805, 1206

### FEATURES

- Typical ESD failure voltage for CMOS and/or Bi Polar is  $\geq 200\text{V}$
- Low capacitance ( $<200\text{pF}$ ) is required for high-speed data transmission.
- Low leakage current (IL) is necessary for battery operated equipment.
- 15kV ESD pulse (air discharge) per IEC 61000-4-2, Level 4, generates  $< 20$  millijoules of energy.

### APPLICATIONS

- Sensors
- CMOS
- SiGe based systems
- Higher speed data lines
- Capacitance sensitive applications and more

### HOW TO ORDER

**VC**  
T  
Varistor Chip

**06**  
T  
Case Size  
04 = 0402  
06 = 0603  
08 = 0805  
12 = 1206

**LC**  
T  
Low Cap Design

**18**  
T  
Working Voltage  
18 = 18.0VDC

**X**  
T  
Energy Rating  
A = 0.10 Joules  
V = 0.02 Joules  
X = 0.05 Joules

**500**  
T  
Clamping Voltage  
500 = 50V

**X**  
T  
Packaging (PCS/REEL)  
D = 1,000\*  
R = 4,000\*  
T = 10,000\*  
W = 10,000\*\*

**P**  
T  
Termination  
P = Ni/Sn

\*Not available for 0402  
\*\*Only available for 0402

### ELECTRIAL CHARACTERISTICS

AVX PN	V <sub>w</sub> (DC)	V <sub>w</sub> (AC)	V <sub>B</sub>	V <sub>C</sub>	I <sub>VC</sub>	I <sub>L</sub>	E <sub>T</sub>	I <sub>P</sub>	Cap	Freq	Size
VC04LC18V500	$\leq 18.0$	$\leq 14.0$	25-40	50	1	10	0.02	15	40	M	0402
VC06LC18X500	$\leq 18.0$	$\leq 14.0$	25-40	50	1	10	0.05	30	50	M	0603
VC08LC18A500	$\leq 18.0$	$\leq 14.0$	25-40	50	1	10	0.1	30	80	M	0805
VC12LC18A500	$\leq 18.0$	$\leq 14.0$	25-40	50	1	10	0.1	30	200	K	1206

V<sub>w</sub>(DC) DC Working Voltage [V]  
V<sub>w</sub>(AC) AC Working Voltage [V]  
V<sub>B</sub> Typical Breakdown Voltage (Min-Max) [V @ 1mA<sub>DC</sub>, 25°C]  
V<sub>C</sub> Clamping Voltage [V @ I<sub>VC</sub>]  
I<sub>VC</sub> Test Current for V<sub>C</sub> [A, 8x20μs]

I<sub>L</sub> Maximum leakage current at the working voltage, 25°C [μA]  
E<sub>T</sub> Transient Energy Rating [J, 10x1000μs]  
I<sub>P</sub> Peak Current Rating [A, 8x20μs]  
Cap Typical capacitance [pF] @ frequency specified and 0.5V<sub>RMS</sub>, 25°C, K = 1kHz, M = 1MHz



### TYPICAL PERFORMANCE DATA

VC06LC18X500 Capacitance Histogram

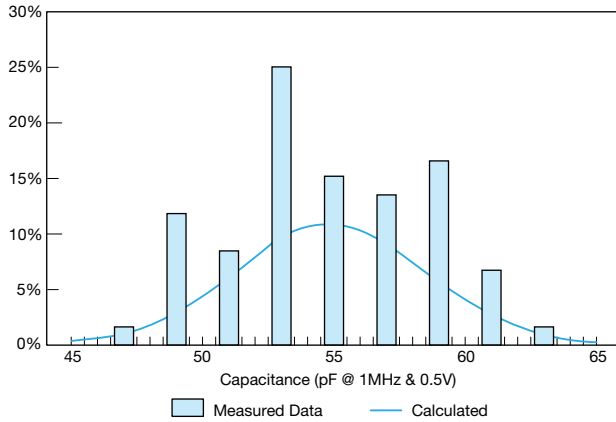

StaticGuard ESD RESPONSE  
IEC 61000-4-2 (8 Kv Contact Discharge)

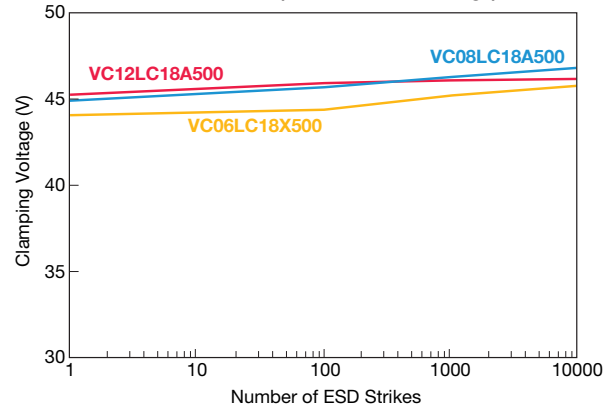

VC08LC18A500 Capacitance Histogram

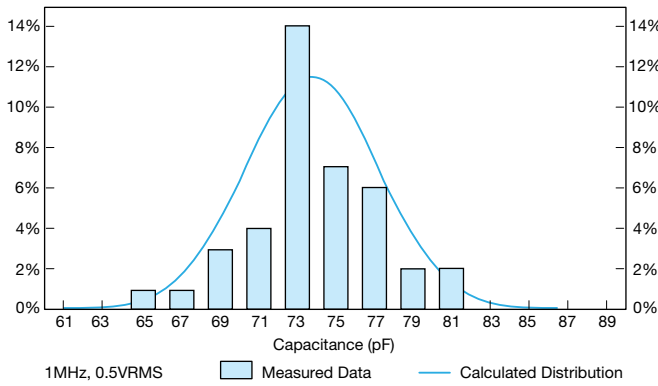

StaticGuard S21

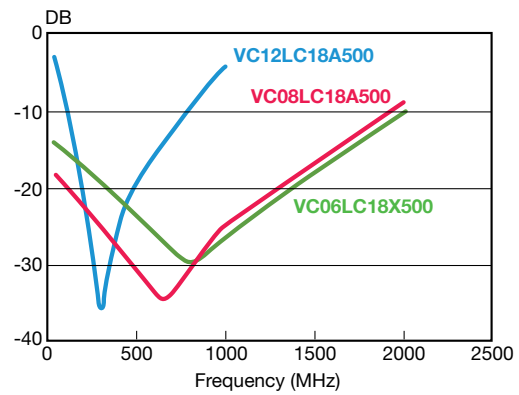

VC12LC18A500 Capacitance Histogram

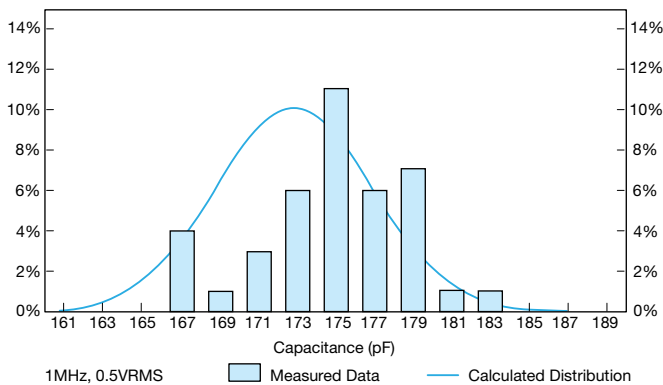

VI Curves - StaticGuard Products

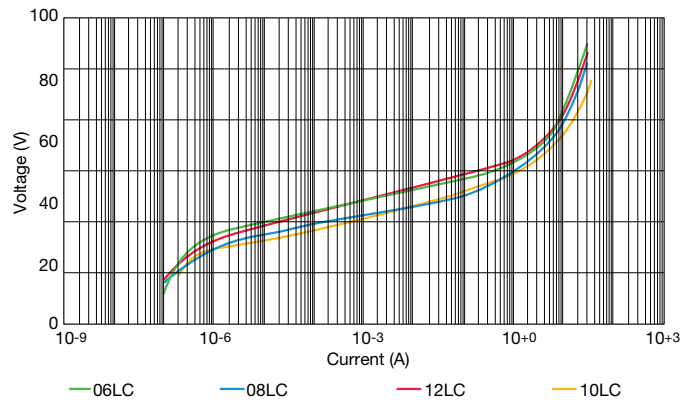

### TYPICAL PERFORMANCE CURVES (0402 CHIP SIZE)

#### VOLTAGE/CURRENT CHARACTERISTICS

Multilayer construction and improved grain structure result in excellent transient clamping characteristics up to 20 amps peak current, while maintaining very low leakage currents under DC operating conditions. The VI curves below show the voltage/current characteristics for the 5.6V, 9V, 14V, 18V and low capacitance StaticGuard parts with currents ranging from parts of a micro amp to tens of amps.

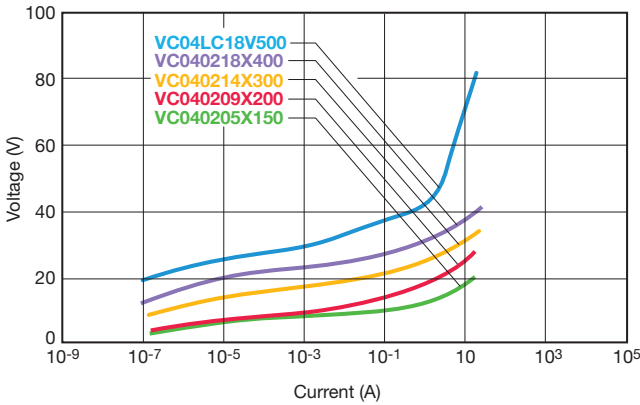

#### PEAK POWER VS PULSE DURATION

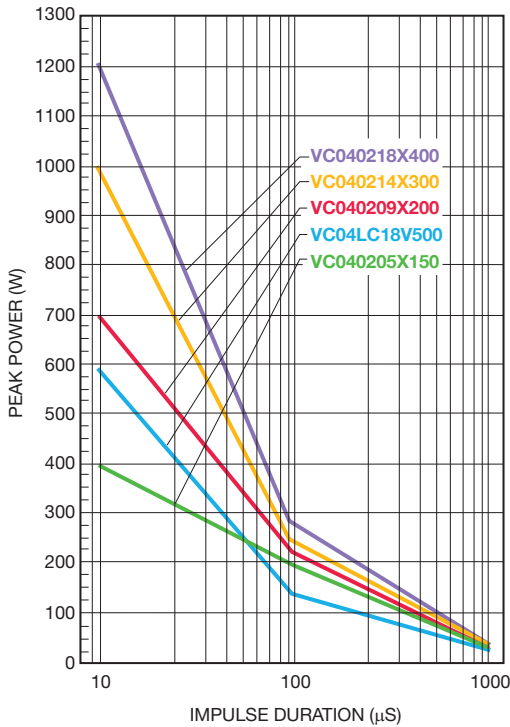

#### PULSE DEGRADATION

Traditionally varistors have suffered degradation of electrical performance with repeated high current pulses resulting in decreased breakdown voltage and increased leakage current. It has been suggested that irregular intergranular boundaries and bulk material result in restricted current paths and other non-Schottky barrier paralleled conduction paths in the ceramic. Repeated pulsing of TransGuard® transient voltage suppressors with 150Amp peak 8 x 20µs waveforms shows negligible degradation in breakdown voltage and minimal increases in leakage current.

#### ESD TEST OF 0402 PARTS

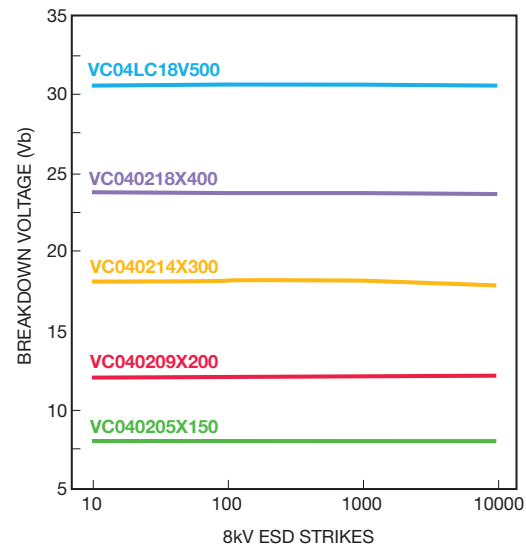

#### INSERTION LOSS CHARACTERISTICS

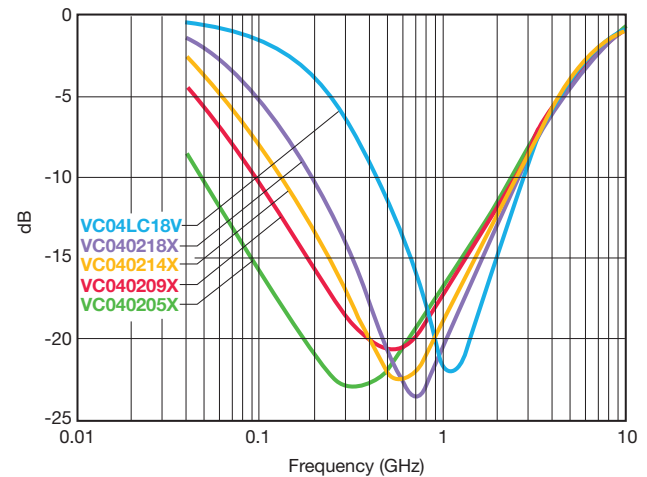



**VOLTAGE/CURRENT CHARACTERISTICS**

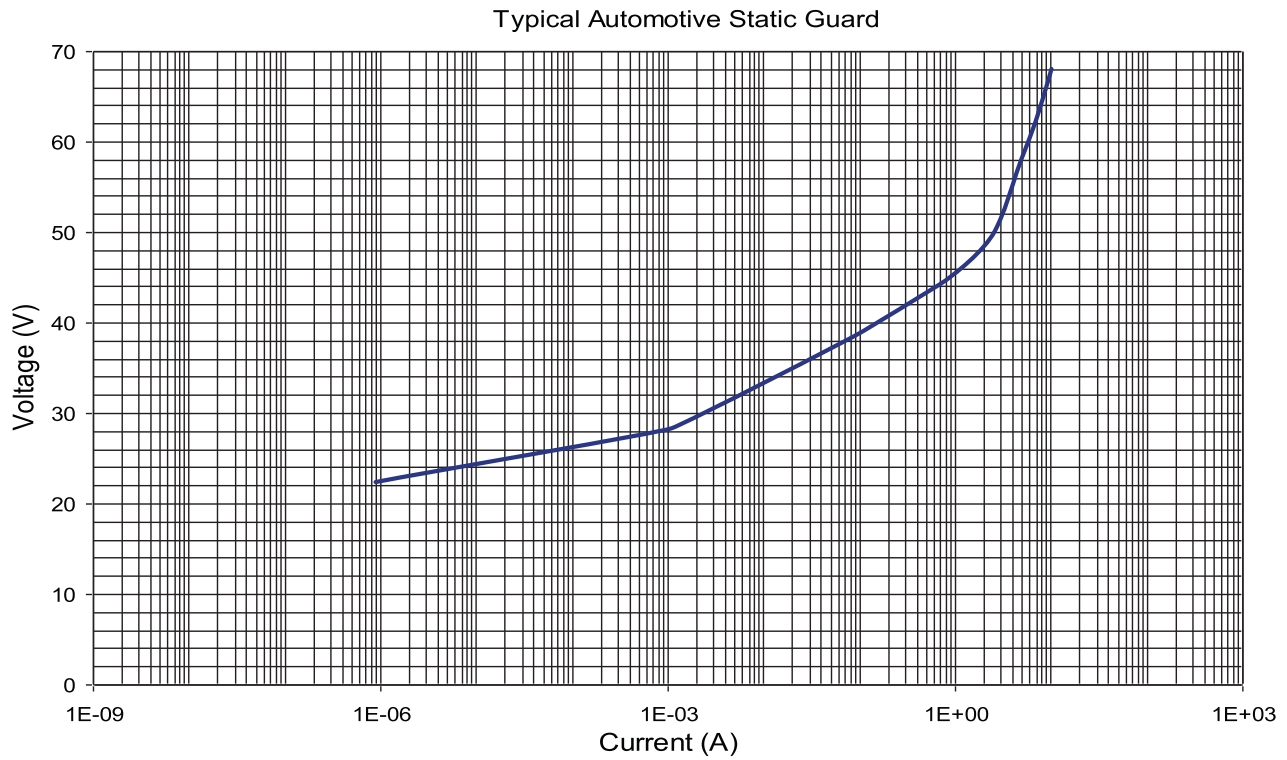

**ELECTRICAL TRANSIENT CONDUCTION**

ISO 7637 Pulse 1-3

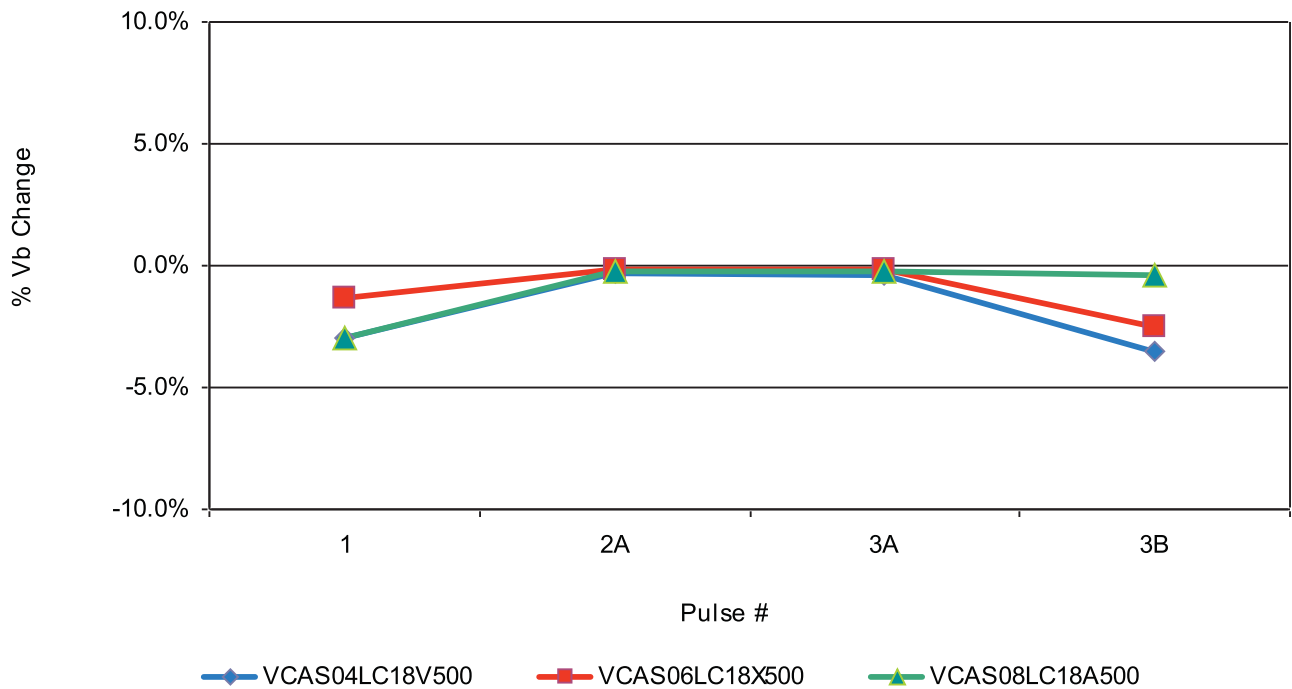

# StaticGuard Automotive Series

## Multilayer Varistors for Automotive Applications



### VOLTAGE/CURRENT CHARACTERISTICS

VCAS04LC18V500

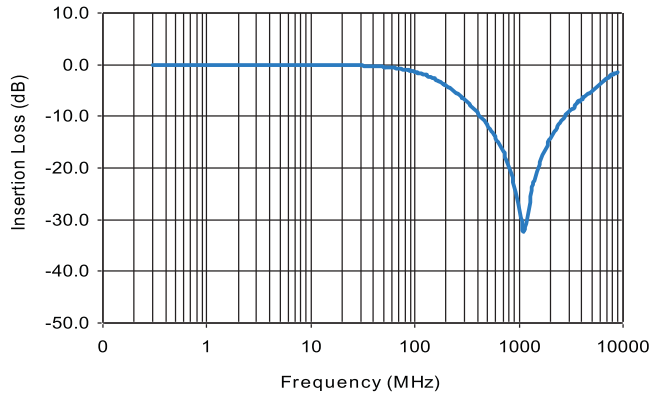

VCAS06LC18X500

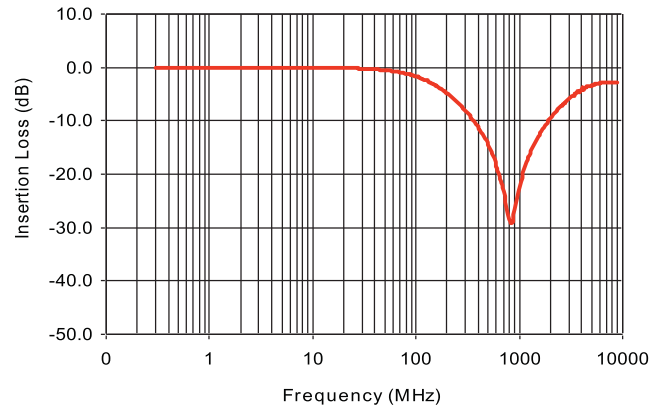

VCAS08LC18A500

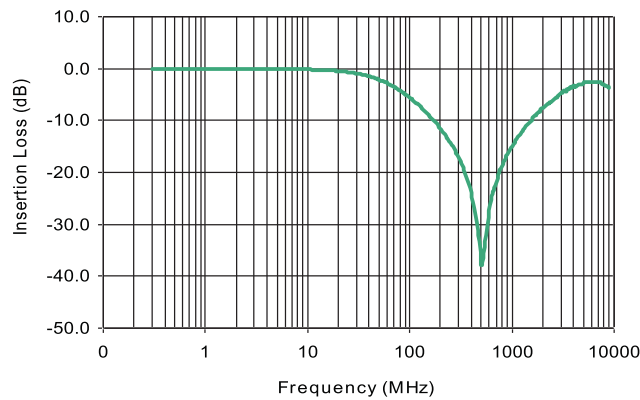

# Miniature 0201 Automotive MLV

## ESD Protection for Automotive Circuits with Board Space Constraints

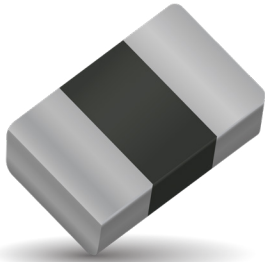

### GENERAL DESCRIPTION

AVX 0201 Multi-Layer Automotive Varistors are designed for circuits where board space is a premium. 0201 MLV offer bi-directional ESD protection in the smallest package available today. The added advantage is EMI/RFI attenuation. 0201 MLV can replace 2 diodes and the EMC capacitor for a one chip solution.

The miniature size and one chip solution team to offer designers the best in ESD protection and EMI filtering in one ultra compact device.

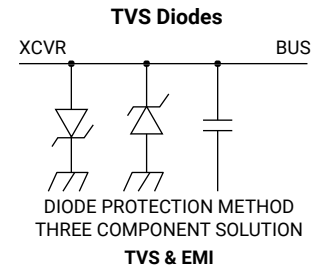
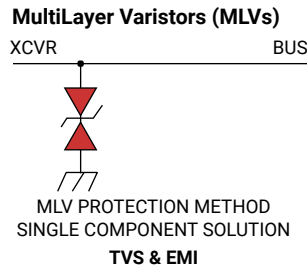

### GENERAL CHARACTERISTICS

- Operating Temperature: -55°C to +125°C
- Working Voltage: 9Vdc
- Case Size: 0201

### APPLICATIONS

- Manifold absolute pressure sensor
- Camera modules
- Embedded components
- Any circuit with space constraints

### FEATURES

- Bi-Directional protection
- AEC-Q200 Qualified
- Low  $V_B$  Version
- Fastest response time to ESD strikes
- Multi-strike capability
- Ultra compact 0201 case size

### HOW TO ORDER

<b>VC</b> Varistor Clamp	<b>AS</b> Automotive Series	<b>0201</b> Chip Size 0201	<b>09</b> Working Voltage 09 = 9V	<b>V</b> Energy Rating V = 0.02J	<b>300</b> Capacitance 300 = 32V	<b>W</b> Package W = 7" 10kpcs	<b>P</b> Termination P = Ni Barrier/ 100% Sn (matte)	 <b>MSL 1</b> <b>Pb Free 260°C</b>
--------------------------------	-----------------------------------	-------------------------------------	--	---	--	---	---	--

AVX PN	V <sub>w</sub> (DC)	V <sub>w</sub> (AC)	V <sub>B</sub>	V <sub>C</sub>	I <sub>vc</sub>	I <sub>L</sub>	E <sub>T</sub>	I <sub>P</sub>	Cap	Cap tol
	Vdc	Vac	V	V	A	µA	J	A	pF	
VCAS020109V300WP	9.0	6.4	16.5±10%	32	1	10	0.02	5	30	±40%

V<sub>w</sub>(DC) DC Working Voltage [V]

V<sub>w</sub>(AC) AC Working Voltage [V]

V<sub>B</sub> Breakdown Voltage [V @ 1mADC]

V<sub>C</sub> Clamping Voltage [V @ IVC]

I<sub>vc</sub> Test Current for VC [A, 8x20µS]

I<sub>L</sub> Maximum leakage current at the working voltage [µA]

E<sub>T</sub> Transient Energy Rating [J, 10x1000µS]

I<sub>P</sub> Peak Current Rating [A, 8x20µS]

Cap Capacitance [pF] @ 1KHz specified and 0.5V<sub>RMS</sub>



The Important Information/Disclaimer is incorporated in the catalog where these specifications came from or available online at [www.avx.com/disclaimer/](http://www.avx.com/disclaimer/) by reference and should be reviewed in full before placing any order.

# Miniature 0201 Automotive MLV

## ESD Protection for Automotive Circuits with Board Space Constraints



### PHYSICAL DIMENSIONS<sup>SL</sup>: mm (inches)

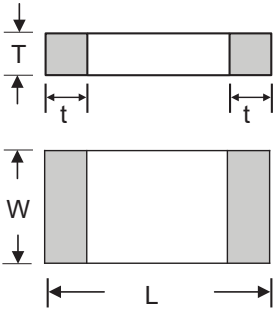

Size (EIA)	Length (L)	Width (W)	Max Thickness (T)	Terminal
0201	0.60±0.03 (0.024±0.001)	0.30±0.03 (0.011±0.001)	0.33 max. (0.013 max.)	0.15±0.05 (0.006±0.002)

### VOLTAGE/CURRENT CHARACTERISTICS

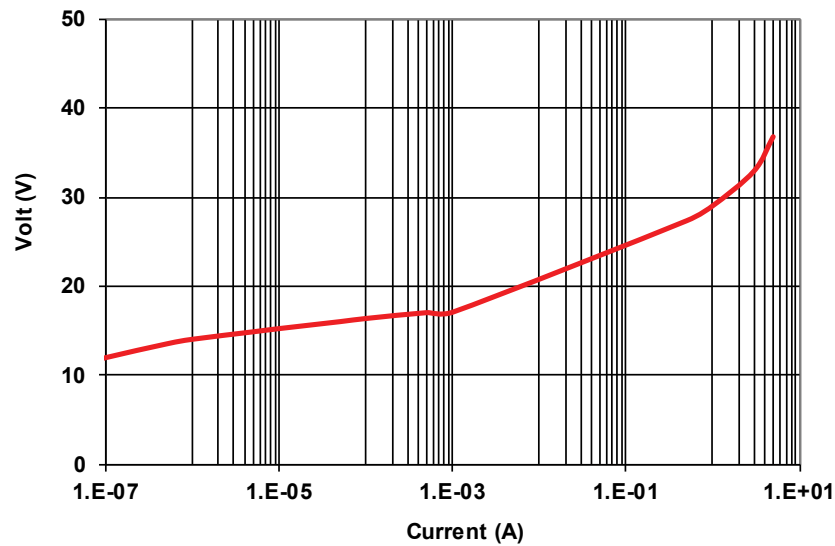

# MultiGuard® Series

## (2&4 Elements) Multilayer Ceramic Transient Voltage Suppression Arrays – ESD Protection for CMOS and Bi Polar Systems

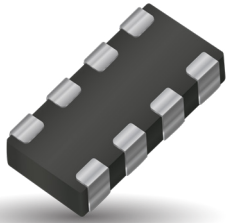

### GENERAL DESCRIPTION

AVX's Transient Voltage Suppression (TVS) Arrays address six trends in today's electronic circuits: (1) mandatory ESD protection, (2) mandatory EMI control, (3) signal integrity improvement, (4) PCB downsizing, (5) reduced component placement costs, and (6) protection from induced slow speed transient voltages and currents.

AVX's MultiGuard® products offer numerous advantages, which include a faster turn-on-time (<1nS), repetitive strike capability, and space savings. In some cases, MultiGuard® consumes less than 75% of the PCB real estate required for the equivalent number of discrete chips. This size advantage, coupled with the savings associated with placing only one chip, makes MultiGuard® the TVS component of choice for ESD protection of I/O lines in portable equipment and programming ports in cellular phones. Other applications include differential data line protection, ASIC protection and LCD driver protection for portable computing devices.

### GENERAL CHARACTERISTICS

- Operating Temperature: -55°C to 125°C
- Working Voltage: 5.6Vdc-18Vdc
- Case Size: 0405 2x Array  
0508 2x Array  
0612 4x Array
- Energy: 0.02-0.1J
- Peak Current: 15-30A

### FEATURES

- Bi-Directional protection
- Very fast response time to ESD strikes
- EMI/RFI filtering in the off-state
- 2 and 4 element arrays
- Multiple lines protection
- Space saving
- Pick & place cost savings

### APPLICATIONS

- I/O Lines
- Portable equipment
- Cell phones, radios
- Programming ports
- Differential data lines
- ASIC
- LCD driver

### HOW TO ORDER

<b>MG</b>	<b>04</b>	<b>2</b>	<b>L</b>	<b>14</b>	<b>A</b>	<b>300</b>	<b>T</b>	<b>P</b>
<b>MultiGuard®</b>	<b>Case Size</b>	<b>Configuration</b>	<b>Style</b>	<b>Working Voltage</b>	<b>Energy Rating</b>	<b>Clamping Voltage</b>	<b>Packaging (PCS/REEL)</b>	<b>Termination Finish</b>
	04 = 0405 05 = 0508 06 = 0612	2 = 2 Elements 4 = 4 Elements	S = Standard Construction L = Low Capacitance	05 = 5.6VDC 09 = 9.0VDC 14 = 14.0VDC 18 = 18.0VDC	A = 0.10 Joules V = 0.02 Joules X = 0.05 Joules	150 = 18V 200 = 22V 300 = 32V 400 = 42V 500 = 50V	D = 1,000 R = 4,000 T = 10,000	P = Ni/Sn (Plated)



# MultiGuard® Series

## (2&4 Elements) Multilayer Ceramic Transient Voltage Suppression Arrays – ESD Protection for CMOS and Bi Polar Systems



### ELECTRICAL CHARACTERISTICS PER ELEMENT

	AVX Part Number	Working Voltage (DC)	Working Voltage (AC)	Breakdown Voltage	Clamping Voltage	Test Current For $V_c$	Maximum Leakage Current	Transient Energy Rating	Peak Current Rating	Typical Cap
2 Element 0405 Chip	MG042S05X150 __	5.6	4.0	8.5±20%	18	1	35	0.05	15	300
	MG042L14V400 __	14.0	10.0	18.5±12%	32	1	15	0.02	15	45
	MG042L18V500 __	18.0	14.0	28.0±10%	50	1	10	0.02	15	40
2 Element 0508 Chip	MG052S05A150 __	5.6	4.0	8.5±20%	18	1	35	0.10	30	825
	MG052S09A200 __	9.0	6.4	12.7±15%	22	1	25	0.10	30	550
	MG052S14A300 __	14.0	10.0	19.5±12%	32	1	15	0.10	30	425
	MG052S18A400 __	18.0	14.0	25.5±10%	42	1	10	0.10	30	225
4 Element 0612 Chip	MG052L18X500 __	≤18.0	≤14.0	28.0±10%	50	1	10	0.10	20	50
	MG064S05A150 __	5.6	4.0	8.5±20%	18	1	35	0.10	30	825
	MG064S09A200 __	9.0	6.4	12.7±15%	22	1	25	0.10	30	550
	MG064S14A300 __	14.0	10.0	19.5±12%	32	1	15	0.10	30	425
	MG064S18A400 __	18.0	14.0	25.5±10%	42	1	10	0.05	15	120
	MG064L18X500 __	≤18.0	≤14.0	28.0±10%	50	1	10	0.10	20	75

Termination Finish Code  
Packaging Code

- $V_w$  (DC) DC Working Voltage (V)
- $V_w$  (AC) AC Working Voltage (V)
- $V_B$  Typical Breakdown Voltage (V @ 1mA<sub>DC</sub>)
- $V_B$  Tol VB Tolerance is ± from Typical Value
- $V_c$  Clamping Voltage (V @  $I_{vc}$ )
- $I_{vc}$  Test Current for VC (A, 8x20μS)
- $I_l$  Maximum Leakage Current at the Working Voltage (μA)
- $E_T$  Transient Energy Rating (J, 10x1000μS)
- $I_p$  Peak Current Rating (A, 8x20μS)
- Cap Typical Capacitance (pF) @ 1MHz and 0.5 V<sub>RMS</sub>

### COMPONENT LAYOUT



SIZE: 0405



SIZE: 0508

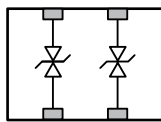

2 Element



SIZE: 0612

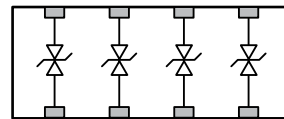

4 Element

# MultiGuard® Series

## (2&4 Elements) Multilayer Ceramic Transient Voltage Suppression Arrays – ESD Protection for CMOS and Bi Polar Systems



### PHYSICAL DIMENSIONS AND PAD LAYOUT

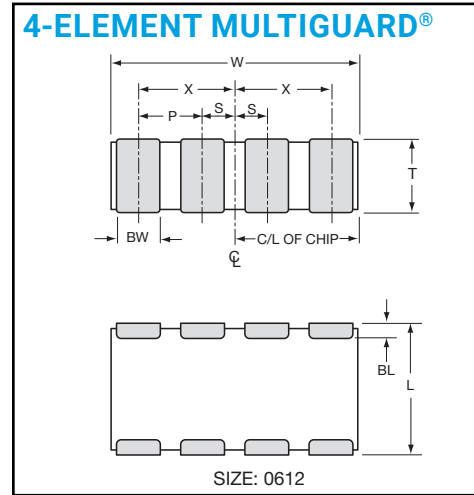
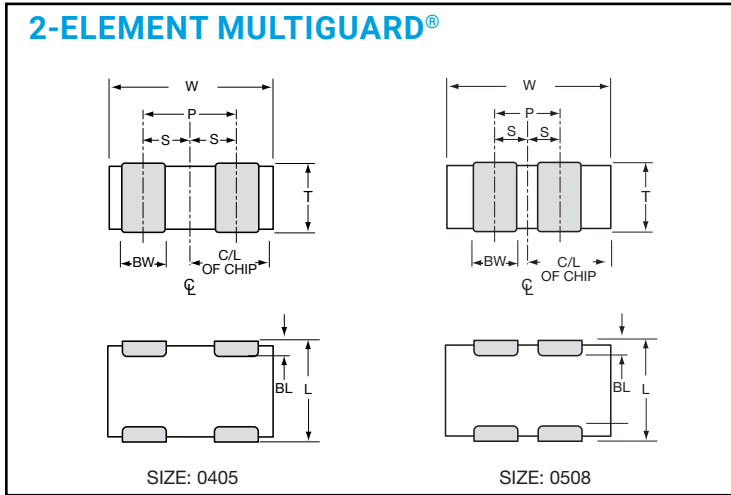

#### 0405 2 ELEMENT DIMENSIONS

mm (inches)

L	W	T	BW	BL	P	S
1.00±0.15 (0.039±0.006)	1.37±0.15 (0.054±0.006)	0.66 MAX (0.026 MAX)	0.36±0.10 (0.014±0.004)	0.20±0.10 (0.008±0.004)	0.64 REF (0.025 REF)	0.32±0.10 (0.013±0.004)

#### 0612 4 ELEMENT DIMENSIONS

mm (inches)

L	W	T	BW	BL	P	X	S
1.60±0.20 (0.063±0.008)	3.20±0.20 (0.126±0.008)	1.22 MAX (0.048 MAX)	0.41±0.10 (0.016±0.004)	0.18 <sup>+0.25</sup> <sub>-0.08</sub> (0.007 <sup>+0.10</sup> <sub>-0.003</sub> )	0.76 REF (0.030 REF)	1.14±0.10 (0.045±0.004)	0.38±0.10 (0.015±0.004)

#### 0508 2 ELEMENT DIMENSIONS

mm (inches)

L	W	T	BW	BL	P	S
1.25±0.20 (0.049±0.008)	2.01±0.20 (0.079±0.008)	1.02 MAX (0.040 MAX)	0.41±0.1 (0.016±0.004)	0.18 <sup>+0.25</sup> <sub>-0.08</sub> (0.007 <sup>+0.10</sup> <sub>-0.003</sub> )	0.76 REF (0.030 REF)	0.38±0.10 (0.015±0.004)

#### PAD LAYOUT DIMENSIONS

mm (inches)

A	B	C	D	E
0405 2 Element				
0.46 (0.018)	0.74 (0.029)	1.20 (0.047)	0.38 (0.015)	0.64 (0.025)

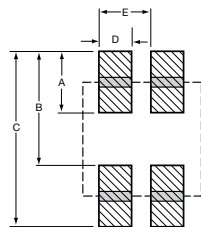

A	B	C	D	E
0508 2 Element				
0.89 (0.035)	1.27 (0.050)	2.16 (0.085)	0.46 (0.018)	0.76 (0.030)

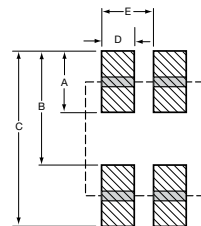

#### PAD LAYOUT DIMENSIONS

mm (inches)

A	B	C	D	E
0612 4 Element				
0.89 (0.035)	1.65 (0.065)	2.54 (0.100)	0.46 (0.018)	0.76 (0.030)

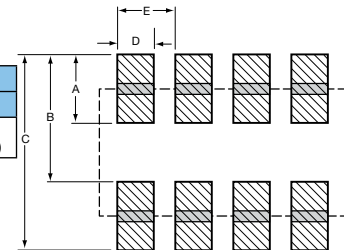

# MultiGuard® Series

## (2&4 Elements) Multilayer Ceramic Transient Voltage Suppression Arrays – ESD Protection for CMOS and Bi Polar Systems



### TYPICAL PERFORMANCE CURVES – VOLTAGE/CURRENT CHARACTERISTICS

Multilayer construction and improved grain structure result in excellent transient clamping characteristics in excess of 30 amps (20 amps on MG064L18X500) peak current while maintaining very low leakage currents under DC operating conditions. The VI curves below show the voltage/current characteristics for the 5.6V, 9V, 14V and 18V parts with currents ranging from fractions of a micro amp to tens of amps.

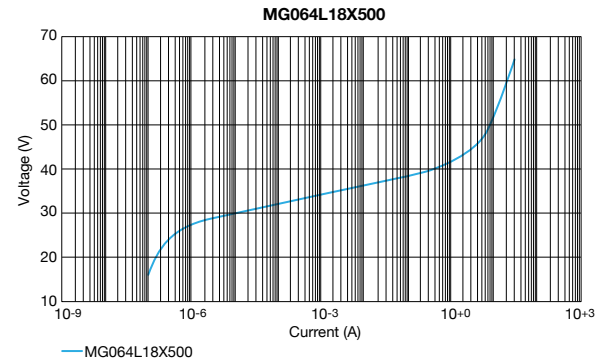
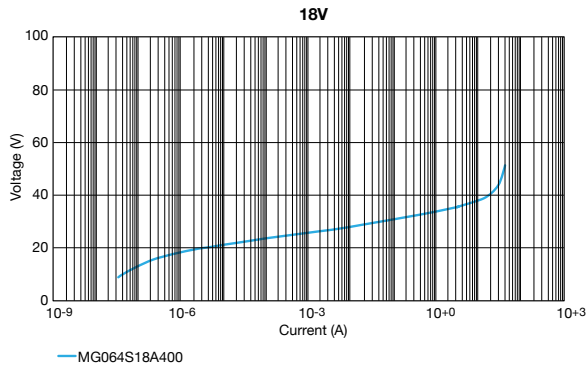
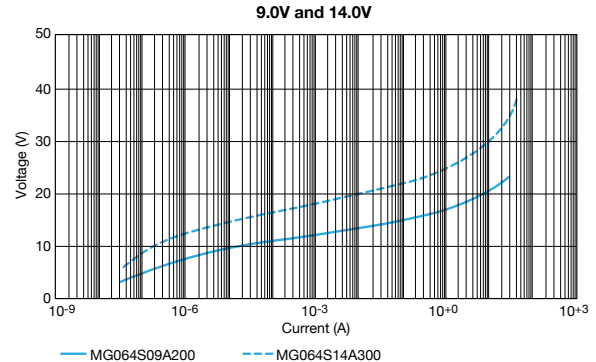
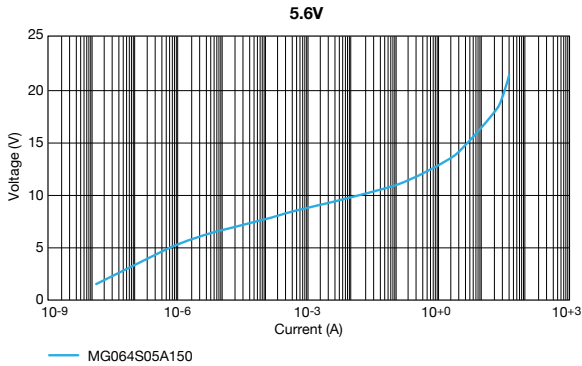

### TYPICAL PERFORMANCE CURVES – TEMPERATURE CHARACTERISTICS

MultiGuard® suppressors are designed to operate over the full temperature range from -55°C to +125°C.

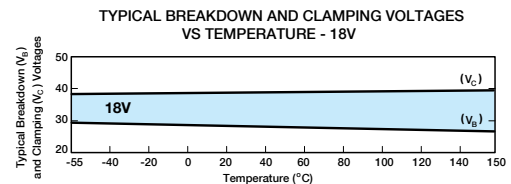
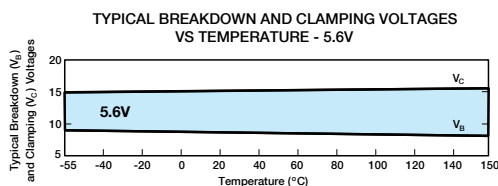
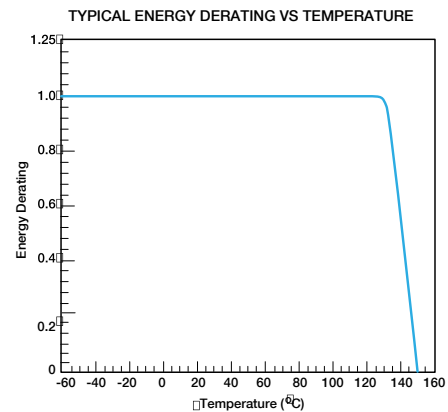
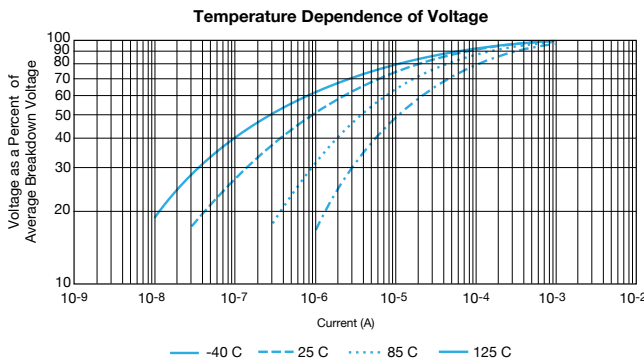

# MultiGuard® Series

## (2&4 Elements) Multilayer Ceramic Transient Voltage Suppression Arrays – ESD Protection for CMOS and Bi Polar Systems



### TRANSIENT VOLTAGE SUPPRESSORS – TYPICAL PERFORMANCE CURVES

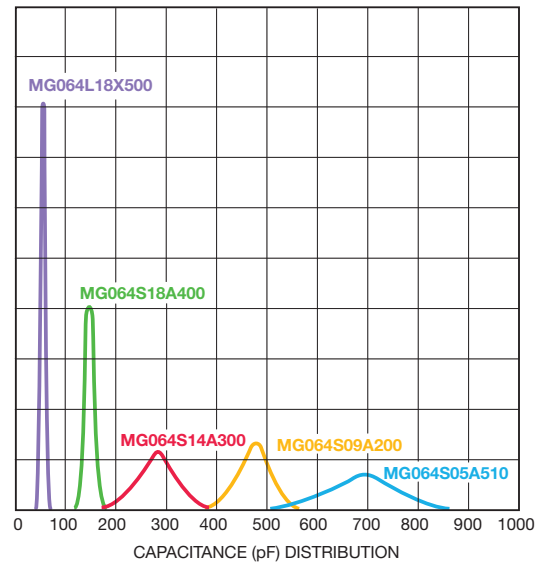
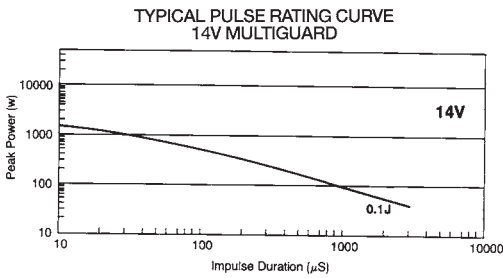
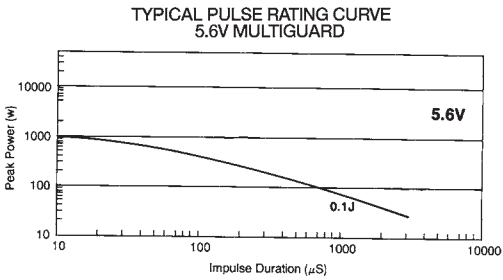

### APPLICATION

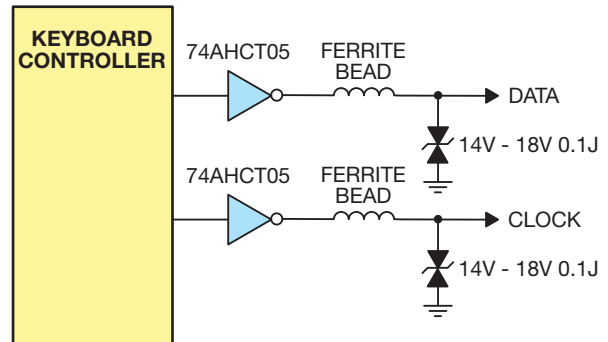
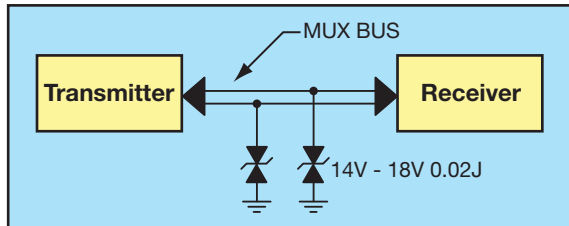

# UltraGuard® Series

## ESD Protection for Low Leakage Requirements



### GENERAL DESCRIPTION

Faster semiconductor clock speeds and an increasing reliance on batteries as power sources have resulted in the need for varistors that exhibit very low leakage current. The UltraGuard® (UG) Series of AVX Transient Voltage Suppressors address this problem.

The UG® Series is the ideal transient protection solution for high clock speed integrated circuit application, battery-operated device, backlit display, medical/instrument application, low voltage power conversion circuits and power supervisory chip sets. In addition, UltraGuard® has low leakage characteristics that are also suitable for optic circuits like LDD, SerDes, and laser diodes.

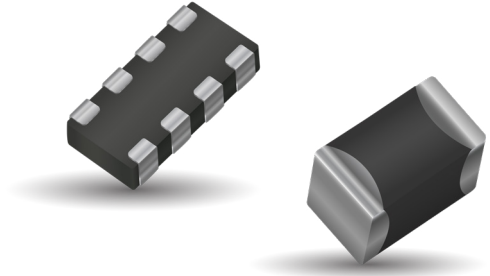

**Discrete Chips**  
0402, 0603,  
and 0805

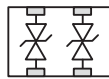

**2-Element Arrays**  
(0405 and 0508)

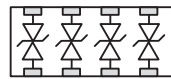

**4-Element Arrays**  
(0612)

### GENERAL CHARACTERISTICS

- Operating Temperature: -55°C to +125°C
- Working Voltage: 3.0dc - 32Vdc
- Case Size: 0402-1206  
0405 2xArray, 0508 2xArray  
0612 4xArray
- Leakage: 1µA Max
- Energy: 0.02-1.2J
- Peak Current: 80-200A
- Typ Cap: 30-5000pF

### FEATURES

- Bi-Directional protection
- Ultra low leakage 1uA max
- Multi-strike capability
- Single, 2 and 4 element components
- Compact footprint
- EMI/RFI filtering

### APPLICATIONS

- Battery operated devices
- High clock speed IC
- Low voltage power conversion
- Power supervisory chip sets
- Optic circuits (LDD, SerDes)
- Laser diodes
- Any circuit with low leakage requirements

### HOW TO ORDER

<b>VC</b> ┆ ┆	<b>UG</b> ┆ ┆	<b>04</b> ┆ ┆	<b>0180</b> ┆ ┆	<b>L</b> ┆ ┆	<b>1</b> ┆ ┆	<b>W</b> ┆ ┆	<b>P</b> ┆ ┆
<b>Surface Mount Chip</b>	<b>Series</b> Low Leakage Series	<b>Case Size</b> 04 = 0402 06 = 0603 08 = 0805 12 = 1206	<b>Maximum Working Voltage</b> 0030 = 3.0VDC 0050 = 5.0VDC 0075 = 7.5VDC 0100 = 10.0VDC 0150 = 15.0VDC 0180 = 18.0VDC 0320 = 32.0VDC	<b>Capacitance</b> L = Low H = High	<b>No. of Elements</b>	<b>Packaging (pieces per reel)</b> D = 1,000 (7" reel) R = 4,000 (7" reel) T = 10,000 (13" reel) W = 10,000 (7" reel, 0402 only)	<b>Termination Finish</b> P = Ni/Sn (Plated)
<b>MG</b> ┆ ┆	<b>UG</b> ┆ ┆	<b>06</b> ┆ ┆	<b>0150</b> ┆ ┆	<b>L</b> ┆ ┆	<b>4</b> ┆ ┆	<b>W</b> ┆ ┆	<b>P</b> ┆ ┆
<b>Array</b>	<b>Series</b> Low Leakage Series	<b>Case Size</b> 04 = 0405 05 = 0508 06 = 0612	<b>Maximum Working Voltage</b> 0030 = 3.0VDC 0050 = 5.0VDC 0075 = 7.5VDC 0100 = 10.0VDC 0150 = 15.0VDC	<b>Capacitance</b> L = Low H = High	<b>No. of Elements</b> 2 = 2 Elements 4 = 4 Elements	<b>Packaging (pieces per reel)</b> D = 1,000 (7" reel) R = 4,000 (7" reel) T = 10,000 (13" reel)	<b>Termination Finish</b> P = Ni/Sn (Plated)

# UltraGuard® Series

## ESD Protection for Low Leakage Requirements



AVX Part Number	VW	VW	VB (Min)	VC	IVC	IL	ET	IP	Cap	Freq	Case	Elements
MGUG040030L2__	3.0	2.3	6.8	18	1	1	0.05	15	300	M	0405	2
MGUG050030L2__	3.0	2.3	17.2	32	1	1	0.1	30	425	M	0508	2
MGUG060030L4__	3.0	2.3	17.2	32	1	1	0.1	30	425	M	0612	4
VCUG040030L1__	3.0	2.3	6.8	18	1	1	0.05	20	175	M	0402	1
VCUG060030L1__	3.0	2.3	6.8	18	1	1	0.1	30	750	K	0603	1
VCUG080030H1__	3.0	2.3	6.8	18	1	1	0.3	120	3000	K	0805	1
VCUG080030L1__	3.0	2.3	6.8	18	1	1	0.1	40	1100	K	0805	1
VCUG120030H1__	3.0	2.3	6.8	18	1	1	0.4	150	3000	K	1206	1
VCUG120030L1__	3.0	2.3	6.8	18	1	1	0.1	40	1200	K	1206	1
MGUG040050L2__	5.0	3.5	20	50	1	1	0.02	15	40	M	0405	2
MGUG050050L2__	5.0	3.5	17.2	32	1	1	0.1	30	425	M	0508	2
MGUG060050L4__	5.0	3.5	17.2	32	1	1	0.1	30	425	M	0612	4
VCUG040050L1__	5.0	3.5	10.8	22	1	1	0.05	20	175	M	0402	1
VCUG060050L1__	5.0	3.5	10.8	22	1	1	0.1	30	550	K	0603	1
VCUG080050L1__	5.0	3.5	10.8	22	1	1	0.1	40	750	K	0805	1
VCUG120050H1__	5.0	3.5	16.3	32	1	1	0.4	150	1050	K	1206	1
VCUG120050L1__	5.0	3.5	16.3	32	1	1	0.1	40	600	K	1206	1
MGUG040075L2__	7.5	5.3	20	50	1	1	0.02	15	40	M	0405	2
MGUG050075L2__	7.5	5.3	17.2	32	1	1	0.1	30	425	M	0508	2
MGUG060075L4__	7.5	5.3	17.2	32	1	1	0.1	30	425	M	0612	4
VCUG040075L1__	7.5	5.3	16.3	32	1	1	0.05	20	85	M	0402	1
VCUG060075L1__	7.5	5.3	16.3	32	1	1	0.1	30	350	K	0603	1
VCUG080075H1__	7.5	5.3	16.3	32	1	1	0.3	120	900	K	0805	1
VCUG080075L1__	7.5	5.3	16.3	32	1	1	0.1	40	325	K	0805	1
VCUG120075H1__	7.5	5.3	16.3	32	1	1	0.4	150	1050	K	1206	1
VCUG120075L1__	7.5	5.3	16.3	32	1	1	0.1	40	600	K	1206	1
MGUG040100L2__	10	7.1	20	50	1	1	0.02	15	40	M	0405	2
MGUG050100L2__	10	7.1	23	42	1	1	0.1	30	225	M	0508	2
MGUG060100L4__	10	7.1	23	42	1	1	0.1	15	120	M	0612	4
VCUG040100L1__	10	7.1	23	42	1	1	0.05	20	65	M	0402	1
VCUG060100L1__	10	7.1	23	42	1	1	0.1	30	150	K	0603	1
VCUG080100H1__	10	7.1	23	42	1	1	0.3	100	550	K	0805	1
VCUG080100L1__	10	7.1	23	42	1	1	0.1	30	225	K	0805	1
VCUG120100H1__	10	7.1	23	42	1	1	0.4	150	900	K	1206	1
VCUG120100L1__	10	7.1	23	42	1	1	0.1	30	350	K	1206	1
MGUG040150L2__	15	11	20	50	1	1	0.02	15	50	M	0405	2
MGUG050150L2__	15	11	20	50	1	1	0.1	20	50	M	0508	2
MGUG060150L4__	15	11	20	50	1	1	0.05	20	75	M	0612	4
VCUG040150L1__	15	11	25	50	1	1	0.02	15	40	M	0402	1
VCUG060150L1__	15	11	31.1	60	1	1	0.1	30	155	K	0603	1
VCUG080150H1__	15	11	31.1	60	1	1	0.3	100	250	K	0805	1
VCUG080150L1__	15	11	31.1	60	1	1	0.1	30	120	K	0805	1
VCUG120150H1__	15	11	31.1	60	1	1	0.4	120	500	K	1206	1
VCUG040180L1__	18	14	28	55	1	1	0.05	10	30	M	0402	1
VCUG080320L1__	32	22	42.3	77	1	1	0.1	40	50	M	0805	1

Termination Finish Code  
 Packaging Code

- V<sub>CIR</sub> (DC) DC Circuit Voltage (V)
- V<sub>CIR</sub> (AC) AC Circuit Voltage (V)
- Cap Req Standard or Low
- I<sub>L</sub> Maximum Leakage Current at the Circuit Voltage (µA)
- Cap Typical Capacitance (pF) @ frequency specified and 0.5 Vrms
- Freq Frequency at which capacitance is measured (K = 1kHz, M = 1MHz)



The Important Information/Disclaimer is incorporated in the catalog where these specifications came from or available online at [www.avx.com/disclaimer/](http://www.avx.com/disclaimer/) by reference and should be reviewed in full before placing any order.

# UltraGuard® Series

## ESD Protection for Low Leakage Requirements



### PHYSICAL DIMENSIONS

mm (inches)

	0402 Discrete	0603 Discrete	0805 Discrete
<b>Length</b>	1.00 ±0.10 (0.040 ±0.004)	1.60 ±0.15 (0.063 ±0.006)	2.01 ±0.20 (0.079 ±0.008)
<b>Width</b>	0.50 ±0.10 (0.020 ±0.004)	0.80 ±0.15 (0.032 ±0.006)	1.25 ±0.20 (0.049 ±0.008)
<b>Thickness</b>	0.60 Max. (0.024 Max.)	0.90 Max. (0.035 Max.)	1.02 Max. (0.040 Max.)
<b>Term Band Width</b>	0.25 ±0.15 (0.010 ±0.006)	0.35 ±0.15 (0.014 ±0.006)	0.71 Max. (0.028 Max.)

	0405 Array	0508 Array	0612 Array
<b>Length</b>	1.00 ±0.15 (0.039 ±0.006)	1.25 ±0.20 (0.049 ±0.008)	1.60 ±0.20 (0.063 ±0.008)
<b>Width</b>	1.37 ±0.15 (0.054 ±0.006)	2.01 ±0.20 (0.079 ±0.008)	3.20 ±0.20 (0.126 ±0.008)
<b>Thickness</b>	0.66 Max. (0.026 Max.)	1.02 Max. (0.040 Max.)	1.22 Max. (0.048 Max.)
<b>Term Band Width</b>	0.36 ±0.10 (0.014 ±0.004)	0.41 ±0.10 (0.016 ±0.004)	0.41 ±0.10 (0.016 ±0.004)

### SOLDER PAD DIMENSIONS

mm (inches)

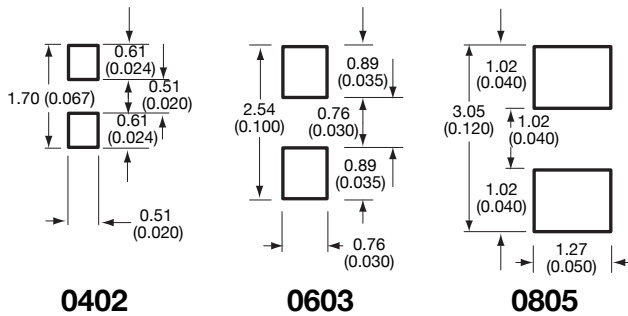

#### 0612 4-Element Array

A	B	C	D	E
0.89 (0.035)	1.65 (0.065)	2.54 (0.100)	0.46 (0.018)	0.76 (0.030)

#### 2-Element Arrays

	A	B	C	D	E
<b>0405</b>	0.46 (0.018)	0.74 (0.029)	1.20 (0.047)	0.38 (0.015)	0.64 (0.025)
<b>0508</b>	0.89 (0.035)	1.27 (0.050)	2.16 (0.085)	0.46 (0.018)	0.76 (0.030)

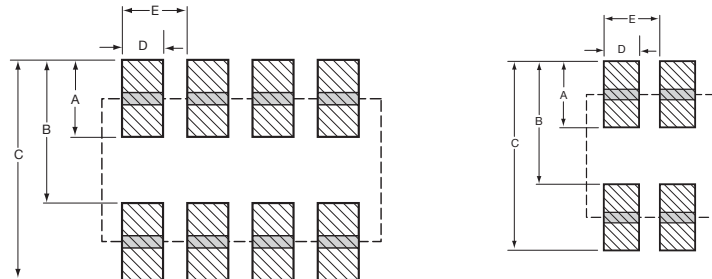

# Communication BUS Varistor

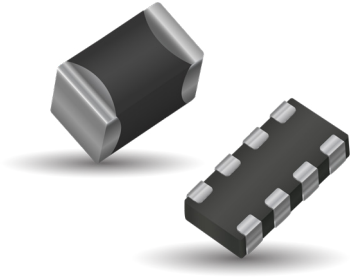

## GENERAL DESCRIPTION

The CAN BUS and FlexRay varistor is a zinc oxide (ZnO) based ceramic semiconductor device with non-linear voltage-current characteristics (bi-directional) similar to back-to-back Zener diodes and an EMC capacitor in parallel (see equivalent circuit model). They have the added advantage of greater current and energy handling capabilities as well as EMI/RFI attenuation. Devices are fabricated by a ceramic sintering process that yields a structure of conductive ZnO grains surrounded by electrically insulating barriers, creating varistor like behavior.

AVX Communication Bus Varistors offer the advantages of large in-rush current capability, low capacitance to minimize signal distortion, fast turn on time to conservatively clamp the energy before its maximum and off state EMI filtering through their bulk capacitance. These features coupled with an extremely low FIT rate and excellent process capability make an ideal device for today's automotive or general circuit protection.

## GENERAL CHARACTERISTICS

- Operating Temperature: -55°C to +125°C
- Working Voltage: ≤18Vdc
- Case Size: 0402, 0603
  - 0405 2xArray
  - 0612 4xArray

## FEATURES

- Compact footprint
- High ESD capability (25kV)
- High Inrush Current (8x20μs)
- EMI/RFI Attenuation
- Low Capacitance/Low Insertion Loss
- Very Fast Response Time
- High Reliability <0.1 FIT
- AEC-Q200 Qualified

## APPLICATIONS

- Communication Bus: CAN Bus, FlexRay, etc.
- General I/O Protocols
- Keyboard Interfaces
- Datalines
- Sensors
- Capacitance sensitive applications and more

## HOW TO ORDER

<b>CAN</b>	<b>0001</b>	<b>D</b>	<b>P</b>	
Style	Case Size	Packaging Code (Reel Size)	Termination	
CAN = CAN BUS FLX = FlexRay	0001 = 0603 Discrete 0002 = 0405 2-Element 0003 = 0405 2-Element 0004 = 0612 4-Element 0005 = 0402 Discrete 0007 = 0603 Discrete	D = 7" reel (1,000 pcs.) R = 7" reel (4,000 pcs.) T = 13" reel (10,000 pcs.) W = 7" reel (10,000 pcs.) 0402 only	P = Ni/Sn (Plated)	

## PERFORMANCE CHARACTERISTICS

AVX PN	V <sub>w</sub> (DC)	V <sub>w</sub> (AC)	V <sub>B</sub>	V <sub>C</sub>	I <sub>vc</sub>	I <sub>L</sub>	E <sub>T</sub>	I <sub>p</sub>	Cap	Freq	VJump	PDiss Max	Case	Elements
CAN0001 __	≤ 18	≤ 14	120	225	1	2	0.015	4	22 Max	M	27.5	0.003	0603	1
CAN0002 __	≤ 18	≤ 14	70	145	1	2	0.015	4	22 Max	M	27.5	0.003	0405	2
CAN0003 __	≤ 18	≤ 14	28.5	50	1	5	0.02	15	50 Max	M	27.5	0.0008	0405	2
CAN0004 __	≤ 18	≤ 14	100	180	1	2	0.015	4	22 Max	M	27.5	0.003	0612	4
CAN0005 __	≤ 18	≤ 14	33	55	1	2	0.05	10	37 Max	M	27.5	0.01	0402	1
CAN0007 __	≤ 32.0	≤ 25.0	61	120	1	5	0.05	5	15 Max	M	27.5	0.003	0603	1
FLX0005 __	≤ 18	≤ 14	26	45	1	5	0.02	4	17 Max	M	27.5	0.004	0402	1

Termination Finish Code  
Packaging Code

V <sub>w</sub> (DC)	DC Working Voltage (V)	I <sub>L</sub>	Maximum Leakage Current at the Working Voltage (μA)
V <sub>w</sub> (AC)	AC Working Voltage (V)	E <sub>T</sub>	Transient Energy Rating (J, 10x1000μS)
V <sub>B</sub>	Typical Breakdown Voltage (V @ 1mADC)	I <sub>p</sub>	Peak Current Rating (A, 8x20μS)
V <sub>C</sub>	Clamping Voltage (V @ I <sub>VC</sub> )	Cap	Maximum Capacitance (pF) @ 1 MHz and 0.5Vrms
I <sub>vc</sub>	Test Current for VC (A, 8x20μS)	Temp Range	-55°C to +125°C



## S21 CHARACTERISTICS

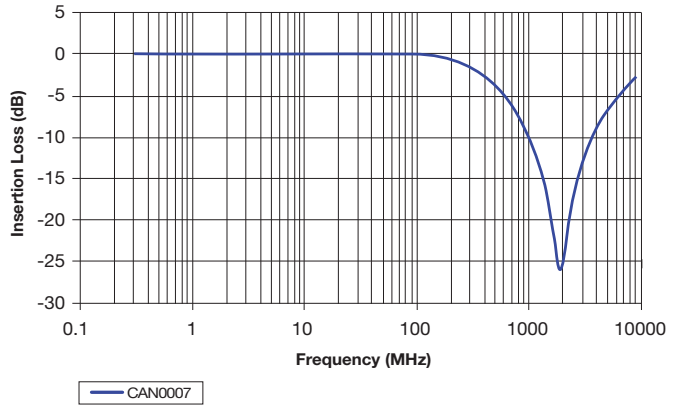
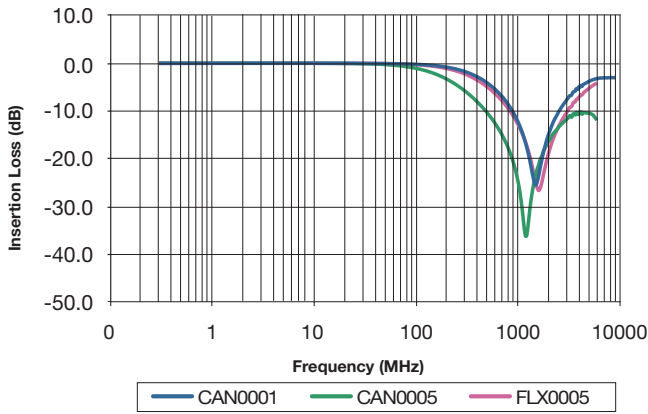

## TYPICAL MLV IMPLEMENTATION

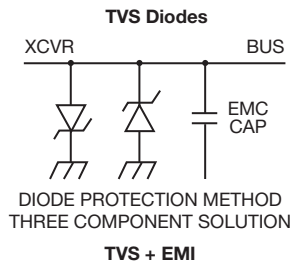
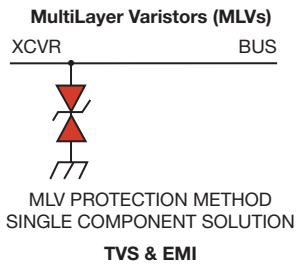

## TYPICAL PULSE RATING CURVE

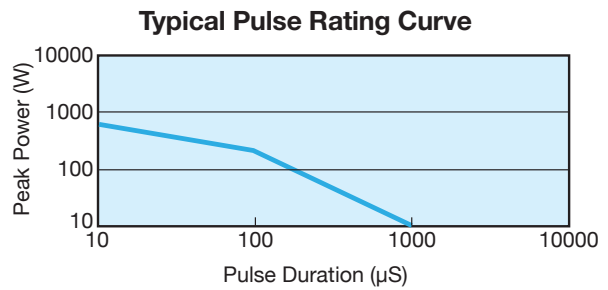

## EQUIVALENT CIRCUIT MODEL

### Discrete MLV Model

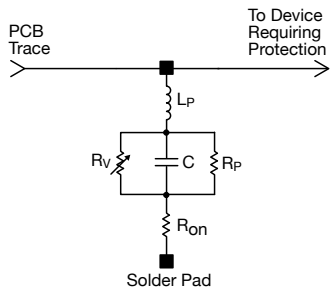

Where:

- $R_v$  = Voltage Variable resistance (per VI curve)
- $R_p \geq 1012 \Omega$
- $C$  = defined by voltage rating and energy level
- $R_{on}$  = turn on resistance
- $L_p$  = parallel body inductance

## TYPICAL CAN BUS IMPLEMENTATION SCHEME

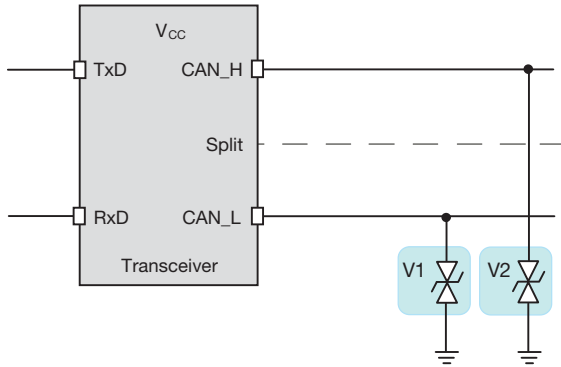

## TYPICAL FLEX RAY IMPLEMENTATION SCHEME

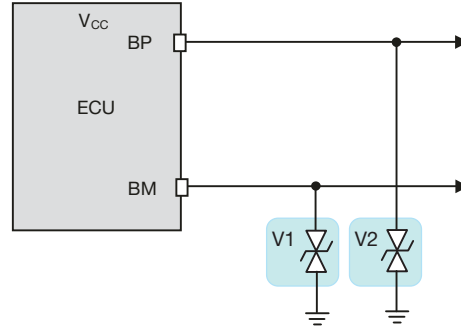

## PHYSICAL DIMENSIONS

mm (inches)

	0402 Discrete	0603 Discrete	0405 Array	0612 Array
<b>Length</b>	1.00 ±0.10 (0.040 ±0.004)	1.60 ±0.15 (0.063 ±0.006)	1.00 ±0.15 (0.039 ±0.006)	1.60 ±0.20 (0.063 ±0.008)
<b>Width</b>	0.50 ±0.10 (0.020 ±0.004)	0.80 ±0.15 (0.032 ±0.006)	1.37 ±0.15 (0.054 ±0.006)	3.20 ±0.20 (0.126 ±0.008)
<b>Thickness</b>	0.60 Max. (0.024 Max.)	0.90 Max. (0.035 Max.)	0.66 Max. (0.026 Max.)	1.22 Max. (0.048 Max.)
<b>Term Band Width</b>	0.25 ±0.15 (0.010 ±0.006)	0.35 ±0.15 (0.014 ±0.006)	0.36 ±0.10 (0.014 ±0.004)	0.41 ±0.10 (0.016 ±0.010)

## SOLDER PAD DIMENSIONS

mm (inches)

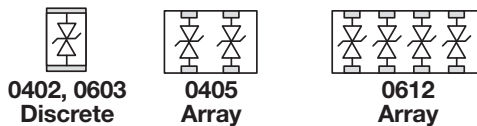
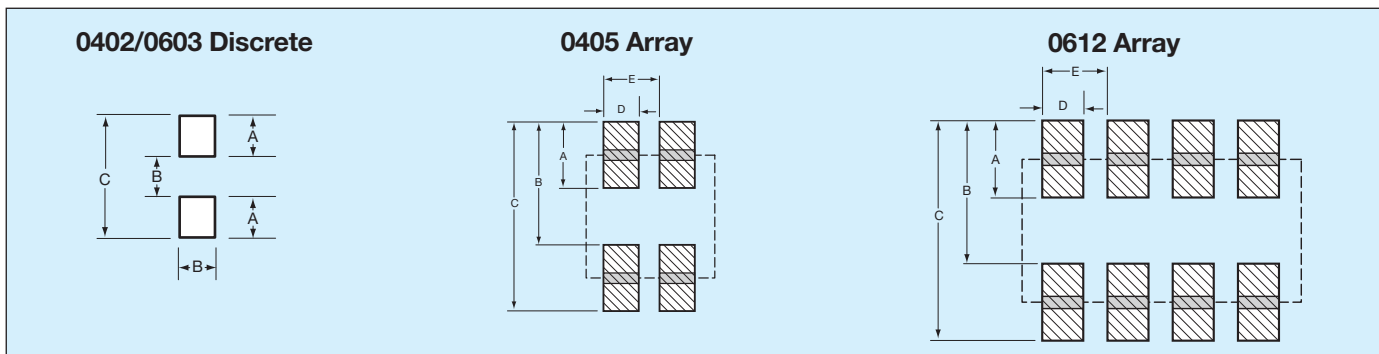

	A	B	C	D	E
<b>0402 Discrete</b>	0.61 (0.024)	0.51 (0.020)	1.70 (0.067)	-	-
<b>0603 Discrete</b>	0.89 (0.035)	0.76 (0.030)	2.54 (0.100)	-	-
<b>0405 Array</b>	0.46 (0.018)	0.74 (0.029)	0.12 (0.047)	0.38 (0.015)	0.64 (0.025)
<b>0612 Array</b>	0.89 (0.035)	1.65 (0.065)	2.54 (0.100)	0.46 (0.018)	0.76 (0.030)

# Communication BUS Varistor

## APPLICATION

AVX CAN BUS and FlexRay varistors offer significant advantages in general areas of a typical CAN or FlexRay network as shown on the right. Some of the advantages over diodes include:

- space savings
- higher ESD capability @ 25kV contact
- higher in rush current (4A) 8 x 20μS
- FIT rate ≤0.1 failures (per billion hours)

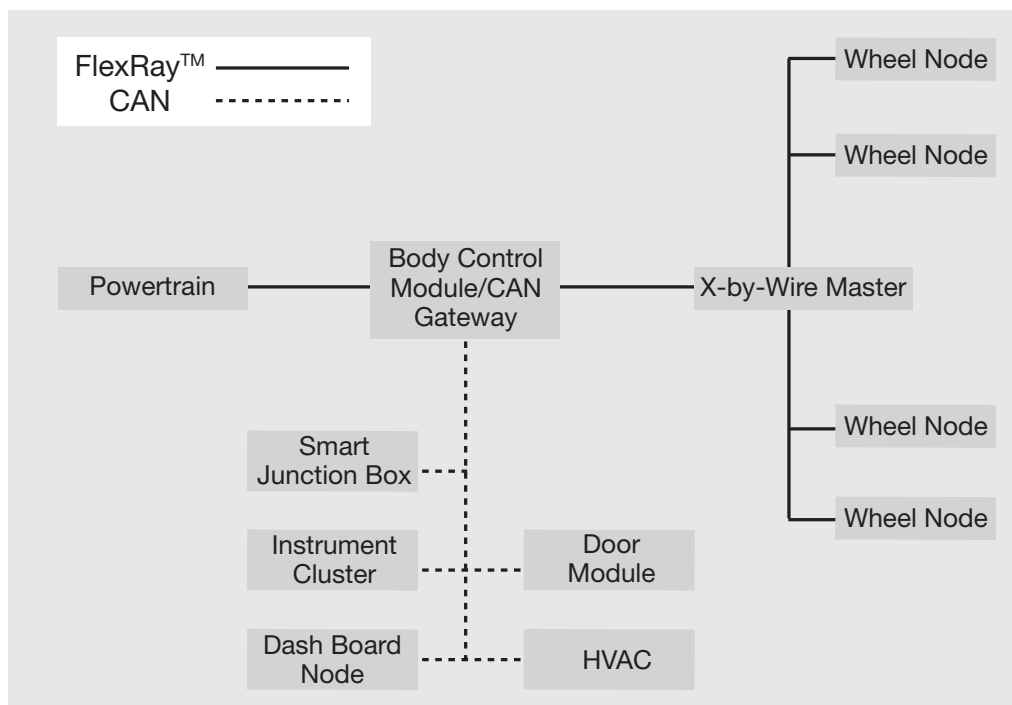
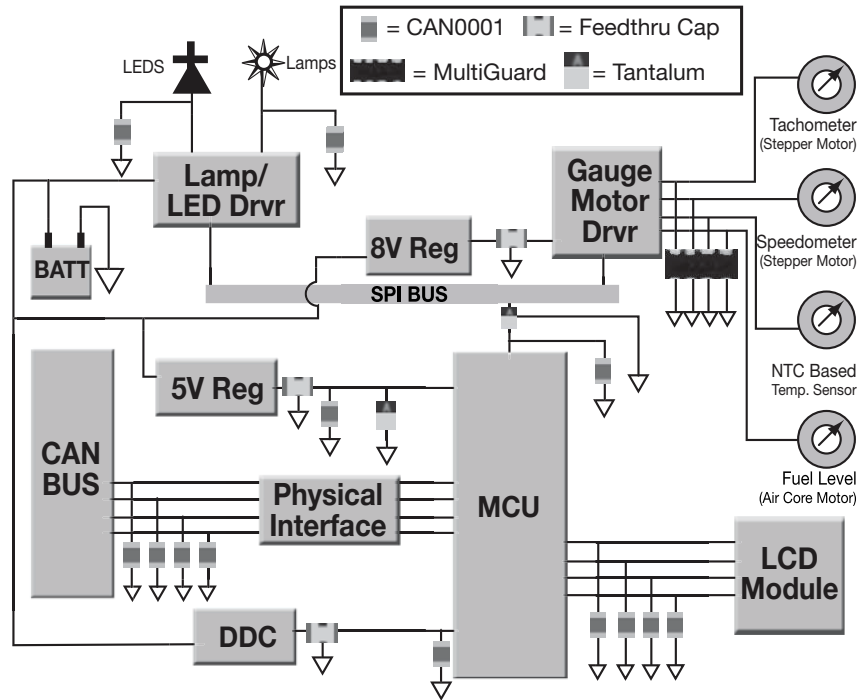

# USB Series

## Low Capacitance Multilayer Varistors

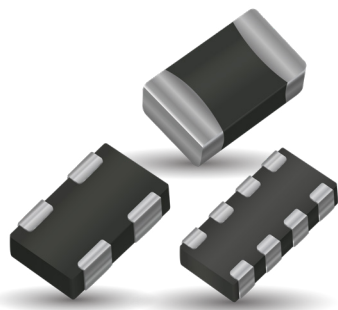

### GENERAL DESCRIPTION

USB Series varistors are designed to protect the high speed data lines against ESD transients. They have very low capacitance and fast turn on times that make this series ideal for data and transmission lines with high data rates. The unique design enables these devices to meet the rigorous testing criteria of the IEC 61000-4-2 standards. New and improved manufacturing process has created these USB series to be one of the best plated varistors in the market today.

### GENERAL CHARACTERISTICS

- Operating Temperature: -55°C to 125°C
- Working Voltage: ≤ 18Vdc
- Case Size: 0402, 0603, 0405 2x array, 0612 4x array
- Typical Capacitance: 3pF, 6pF, 10pF

### FEATURES

- Zinc Oxide (ZnO) based ceramic semiconductor devices with non-linear voltage-current characteristics
- Bi-directional device, similar to back-to-back Zener diodes plus an EMC capacitor in parallel
- Entire structure made up of conductive ZnO grains surrounded by electrically insulating barriers, creating varistor-like behavior
- Electrical advantages over Zener diodes are repetitive strike capability, high in rush current capability, fast turn-on-time and EMI attenuation
- Protects against ESD to meet IEC 61000-4-2 15kV (air) and 8kV (contact)
- Low capacitance for high speed data lines
- Available in discrete and array packages (2 and 4 element)
- Low Clamping Voltage
- Low Operating Voltage
- Response time is < 1ns

### TYPICAL APPLICATIONS

- USB BUS Lines/Firewire Data BUS Lines
- I/O BUS Lines
- 10/100/1000 Ethernet
- Transmission Lines
- Video Card Data Lines
- Handheld Devices
- Laptop Computers
- LCD Monitors and more

### PART NUMBERING

<b>USB</b>	<b>0001</b>	<b>D</b>	<b>P</b>
<b>Style</b>	<b>Case Size</b>	<b>Packaging Code (Reel Size)</b>	<b>Termination</b>
	0001 = 0603 (Single)	D = 7" (1,000 pcs.)	P = Ni/Sn (Plated)
	0002 = 0405 (2-Element)	R = 7" (4,000 pcs.)	
	0004 = 0612 (4-Element)	T = 13" (10,000 pcs.)	
	0005 = 0402 (Single)	W = 7" (10,000 pcs.)	
	0006 = 0402 (Single)	0402 only)	



### PINOUT CONFIGURATION

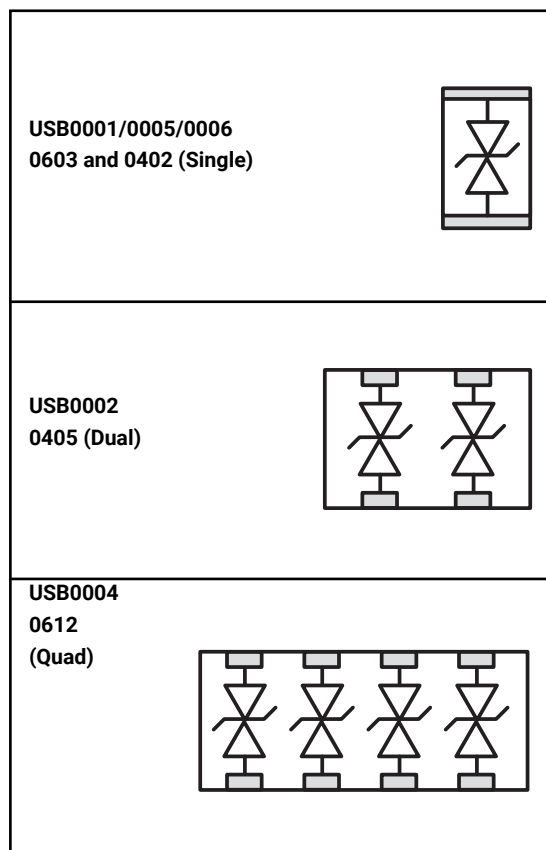

# USB Series

## Low Capacitance Multilayer Varistors

### RATINGS

<b>Air Discharge ESD</b>	15kV
<b>Contact Discharge ESD</b>	8kV
<b>Operating Temperature</b>	-55°C to +125°C
<b>Soldering Temperature</b>	260°C

### PERFORMANCE CHARACTERISTICS

AVX Part No.	VW (DC)	VW (AC)	VB	IL	ET	IP	Cap.	Case Size	Elements
USB0001_ _	≤18	≤14	120	2	0.015	4	10	0603	1
USB0002_ _	≤18	≤14	70	2	0.015	4	10	0405	2
USB0004_ _	≤18	≤14	100	2	0.015	4	10	0612	4
USB0005_ _	≤18	≤14	300	2	0.015	4	3	0402	1
USB0006_ _	≤18	≤14	65	2	0.015	4	6	0402	1

└ Termination Finish Code  
└ Packaging Code

- V<sub>w</sub> (DC) DC Working Voltage (V)
- V<sub>w</sub> (AC) AC Working Voltage (V)
- V<sub>B</sub> Typical Breakdown Voltage (V @ 1mA<sub>DC</sub>)
- I<sub>L</sub> Maximum Leakage Current at the Working Voltage (μA)
- E<sub>T</sub> Transient Energy Rating (J, 10x1000μS)
- I<sub>p</sub> Peak Current Rating (A, 8x20μS)
- Cap Typical Capacitance (pF) @ 1 MHz and 0.5V<sub>rms</sub>

### USB TYPICAL S21 CHARACTERISTICS

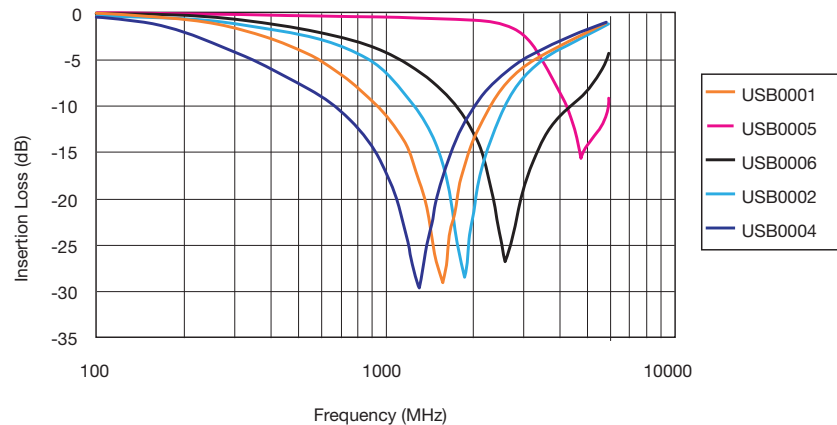

### Typical Pulse Rating Curve

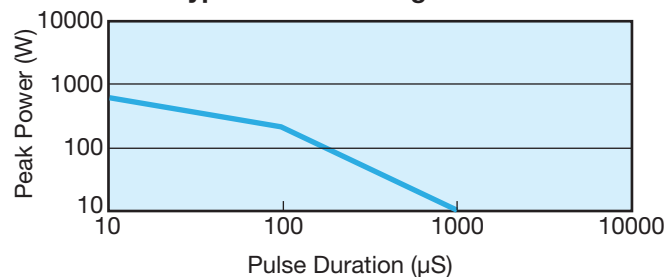

# USB Series

## Low Capacitance Multilayer Varistors

### PHYSICAL DIMENSIONS AND PAD LAYOUT

**USB0001/5/6 (Single)**

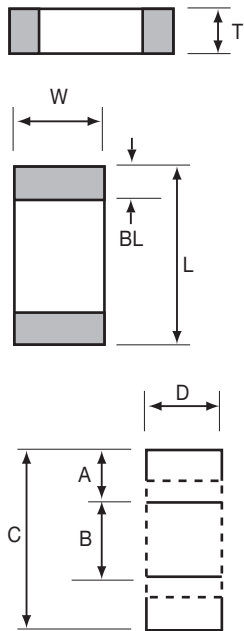

**USB0002 (Dual)**

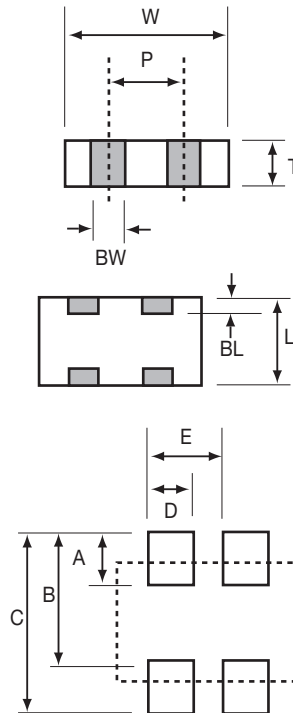

**USB0004 (Quad)**

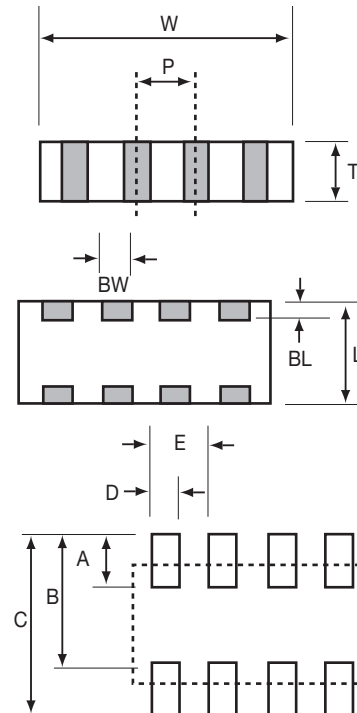

mm (inches)

L	W	T	BW	BL	P
<b>USB0001</b>					
1.60±0.15 (0.063±0.006)	0.80±0.15 (0.032±0.006)	0.90 Max (0.035 Max.)	N/A	0.35±0.15 (0.014±0.006)	N/A
<b>USB0002</b>					
1.00±0.15 (0.039±0.006)	1.37±0.15 (0.054±0.006)	0.66 Max (0.026 Max.)	0.36±0.10 (0.014±0.004)	0.20±0.10 (0.008±0.004)	0.64 REF (0.025 REF)
<b>USB0004</b>					
1.60±0.20 (0.063±0.008)	3.20±0.20 (0.126±0.008)	1.22 Max (0.048 Max.)	0.41±0.10 (0.016±0.004)	0.18+0.25/-0.08 (0.007+0.01/-0.003)	0.76 REF (0.030 REF)
<b>USB0005 / USB0006</b>					
1.0±0.10 (0.040±0.004)	0.50±0.10 (0.020±0.004)	0.60 Max (0.024 Max.)	N/A	0.25±0.15 (0.010±0.006)	N/A

mm (inches)

A	B	C	D	E
<b>USB0001</b>				
0.89 (0.035)	0.76 (0.030)	2.54 (0.100)	0.76 (0.030)	N/A
<b>USB0002</b>				
0.46 (0.018)	0.74 (0.029)	1.20 (0.047)	0.30 (0.012)	0.64 (0.025)
<b>USB0004</b>				
0.89 (0.035)	1.65 (0.065)	2.54 (0.100)	0.46 (0.018)	0.76 (0.030)
<b>USB0005 / USB0006</b>				
0.61 (0.024)	0.51 (0.020)	1.70 (0.067)	0.51 (0.020)	N/A

**APPLICATIONS**

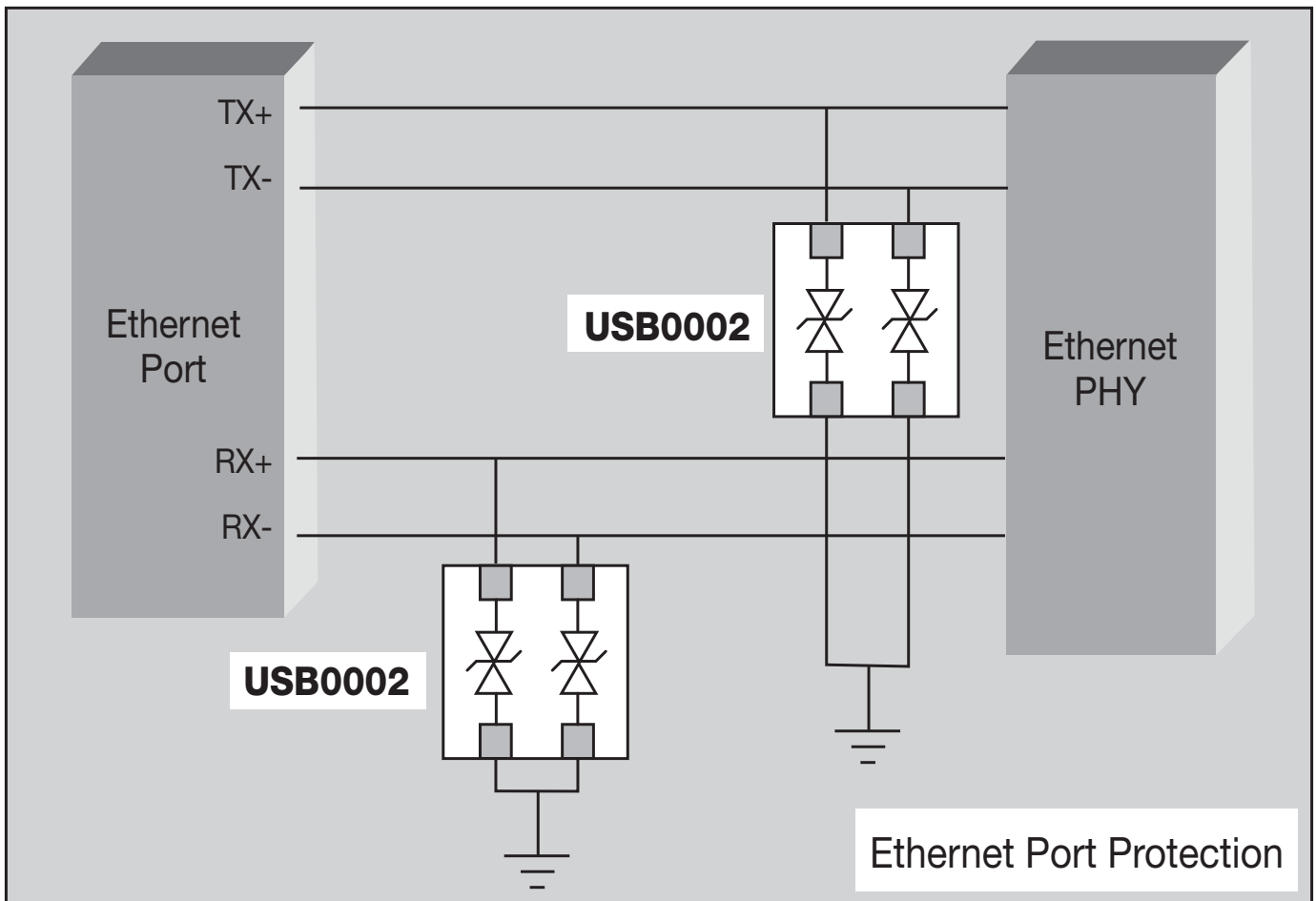
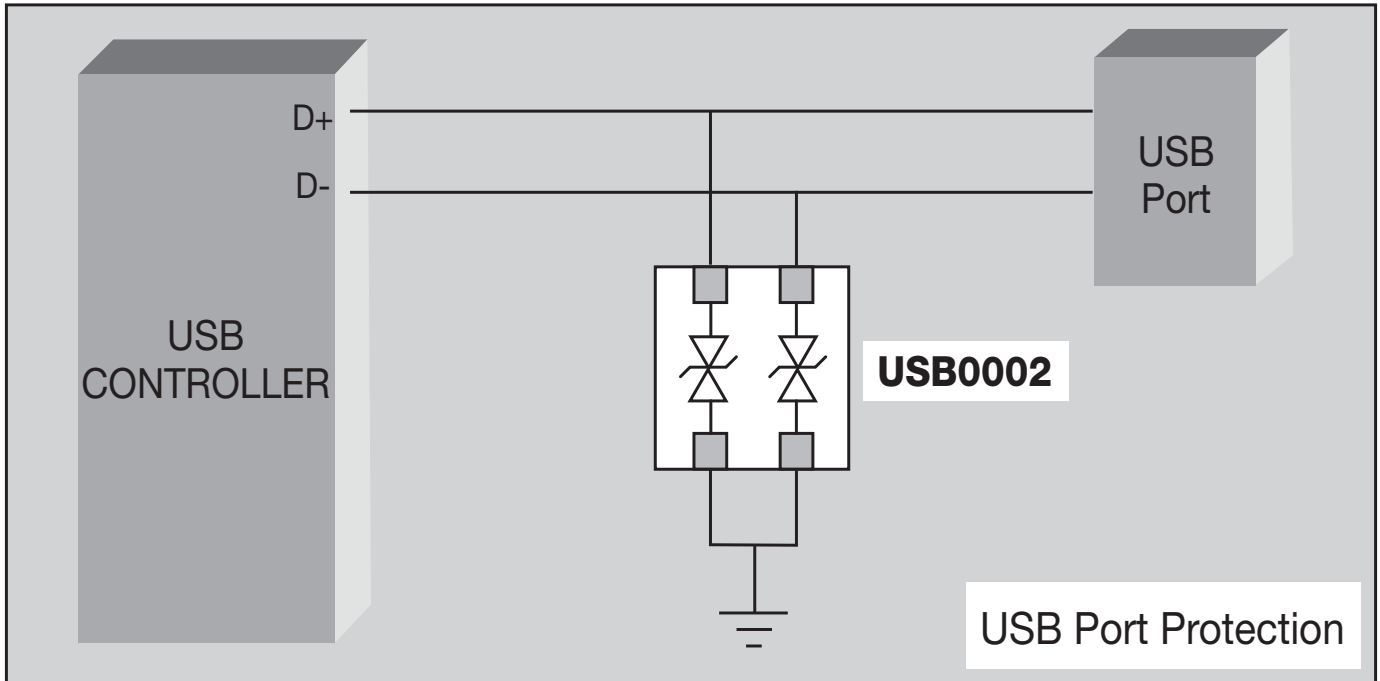

# AntennaGuard Series

## 0402/0603 Low Capacitance Multilayer Varistors

### ESD Protection for Antennas and Low Capacitor Loading Applications



#### GENERAL DESCRIPTION

AVX's 0402/0603 AntennaGuard products are an ultra-low capacitance extension of the proven TransGuard® TVS (transient voltage suppression) line of multilayer varistors. RF designers now have a single chip option over conventional protection methods (passive filters with diode clamps), which not only gives superior performance over traditional schemes, but also provides the added benefits of reduced PCB real estate and lower installation costs.

AVX's AntennaGuard products are available in capacitance ratings of  $\leq 3\text{pF}$  (0402 & 0603 chips), 2 and 12pF (0603 chip). These low capacitance values have low insertion loss, as well as give other TransGuard® advantages such as small size, sub-nanosecond response time, low leakage currents and unsurpassed reliability (FIT Rate of 0.2) compared to diodes.

RF antenna/RF amplifier protection against ESD events is a growing concern of RF circuit designers today, given the combination of increased signal "gain" demands, coupled with the required downsizing of the transistor package. The ability to achieve both objectives is tied to a reduced thickness of the SiO<sub>2</sub> gate insulator layer within the semiconductor. The corresponding result of such a change increases the Power Amplifier's (PA's) vulnerability to ESD strikes – a common event with handheld electronic products with RF transmitting and/or receiving features. AVX Low Capacitance AG Series parts are ideal solution for this type of applications as well as for many more where low capacitance ESD protection is needed.

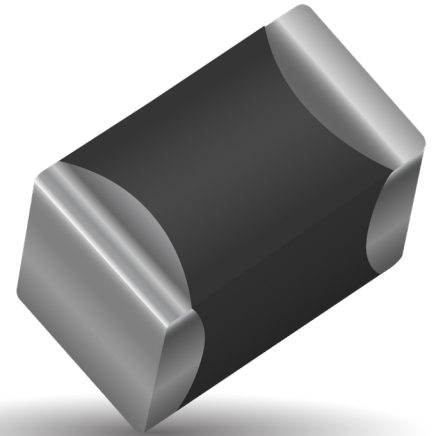

#### GENERAL CHARACTERISTICS

- Operating Temperature: -55°C to +125°C
- Working Voltage:  $\leq 18\text{Vdc}$
- Case Size: 0402, 0603

#### FEATURES

- Smallest TVS Component
- Single Chip Solution
- Low Insertion Loss
- Fastest Response Time to ESD Strikes
- Capacitance: 2, 3 and 12pF

#### APPLICATIONS

- RF Amplifiers
- Antennas
- Laser Drivers
- Sensors
- Radars
- RFID
- Keyless entry
- Near field communication
- Datalines
- Capacitance sensitive applications and more

#### HOW TO ORDER

VC	04	AG	18	3R0	Y	A	T	x	x
<b>Varistor Chip</b>	<b>Chip Size</b>	<b>Varistor Series</b>	<b>Working Voltage</b>	<b>Capacitance</b>	<b>Non-Std. Cap Tolerance</b>	<b>Not Applicable</b>	<b>Capacitance</b>	<b>Reel Size</b>	<b>Reel Quantity</b>
	04 = 0402 06 = 0603	AntennaGuard	(DC)	2pF = 2R0 3pF = 3R0 12pF = 120	C = $\pm 0.25\text{pF}$ (2R0) Y = Max (3R0) Y = +4, -2pF (120)		T = Ni/Sn (Plated)	1 = 7" 3 = 13" W = 7" (0402 only)	A = 4,000 or 10,000 (i.e., 1A = 4,000 3A = 10,000) WA = 10,000





# AntennaGuard Series

## 0402/0603 Low Capacitance Multilayer Varistors

### ESD Protection for Antennas and Low Capacitor Loading Applications



#### ANTENNAGUARD CATALOG PART NUMBERS/ELECTRICAL VALUES

AVX Part Number	VW (DC)	VW (AC)	IL	Cap	Cap Tolerance	Case Size
VC04AG183R0YAT__	≤ 18	≤ 14	0.1	3	Max	0402
VC06AG182R0CAT__	≤ 18	≤ 14	0.1	2	±0.25pF	0603
VC06AG183R0YAT__	≤ 18	≤ 14	0.1	3	Max	0603
VC06AG18120YAT__	≤ 18	≤ 14	0.1	12	+4, -2pF	0603

Termination Finish Code  
Packaging Code

$V_w$  (DC)

$V_w$  (AC)

$I_L$

Cap

DC Working Voltage (V)

AC Working Voltage (V)

Maximum Leakage Current at the Working Voltage ( $\mu$ A)

Maximum Capacitance (pF) @ 1 MHz and 0.5 Vrms; VC06AG18120YAT capacitance tolerance: +4, -2pF

#### PHYSICAL DIMENSIONS

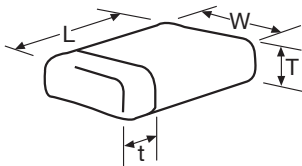

mm (inches)

Size (EIA)	Length (L)	Width (W)	Max Thickness (T)	Land Length (t)
0402	1.00±0.10 (0.040±0.004)	0.50±0.10 (0.020±0.004)	0.60 (0.024)	0.25±0.15 (0.010±0.006)
0603	1.60±0.15 (0.063±0.006)	0.80±0.15 (0.031±0.006)	0.90 (0.035)	0.35±0.15 (0.014±0.006)

#### SOLDERING PAD DIMENSIONS

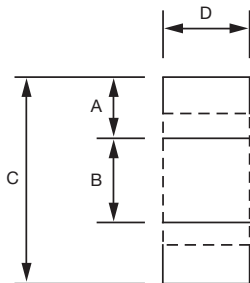

mm (inches)

Suppression Device	Pad Dimensions			
	A	B	C	D
AVX 0402	1.70 (0.067)	0.61 (0.024)	0.51 (0.020)	0.61 (0.024)
AVX 0603	2.54 (0.100)	0.89 (0.035)	0.76 (0.030)	0.89 (0.035)

# AntennaGuard Series

## 0402/0603 Low Capacitance Multilayer Varistors

### ESD Protection for Antennas and Low Capacitor Loading Applications



#### ANTENNA VARISTORS

AVX offers a series of 0402 and 0603 chip varistors, designated the AntennaGuard series, for RF antenna/RF amplifier protection. These devices offer ultra-low capacitance (<math><3\text{pF}</math> in 0402 chips, and  $\leq 3\text{pF}& \leq 12\text{pF}</math> in 0603 packages), as well as low insertion loss. Antenna varistors can replace output capacitors and provide ESD suppression in RF and capacitance sensitive applications.$

It is very common to employ some form of a FET in many types of efficient/miniature RF amplifiers. Typically, these RF transistors have nearly ideal input gate impedance and outstanding noise figures. However, FETs are very susceptible to ESD damage due to the very thin layer of  $\text{SiO}_2$  uses as the gate insulator. The ultra-thin  $\text{SiO}_2$  layer is required to improve the gain of the transistor. In other words, the upside of the performance enhancement becomes the downside of the transistors survival when subjected to an ESD event.

ESD damage to the RF Field Effect Transistors (FETs) is a growing concern

among RF designers due to the following trends: (1) RF amplifiers continue to shrink in size, and (2) FET gains figures continue to increase. Both trends relate to decreasing gate oxide thickness, which in turn, is directly proportional to increased ESD sensitivity. As miniaturization trends accelerate, the traditional methods to protect against ESD damage (i.e., PC board layout, passive filters, and diode clamps) are becoming less and less effective.

AVX's AntennaGuard varistor can be used to protect the FET and offer superior performance to the previously mentioned protection methods given above. The standard EIA 0603 chip size, and particularly the 0402 chip, offer designers an ESD protection solution consistent with today's downsizing trend in portable electronic products. Savings in component volume up to 86%, and PC board footprint savings up to 83% are realistic expectations. These percentages are based upon the following table and Figures 1A and 1B.

mm (inches)

Suppression Device	Pad Dimensions				
	D1	D2	D3	D4	D5
AVX 0402 TransGuard®	1.70 (0.067)	0.61 (0.024)	0.51 (0.020)	0.61 (0.024)	0.51 (0.020)
AVX 0603 TransGuard®	2.54 (0.100)	0.89 (0.035)	0.76 (0.030)	0.89 (0.035)	0.76 (0.030)
Competitor's SOT23 Diode	See Below				

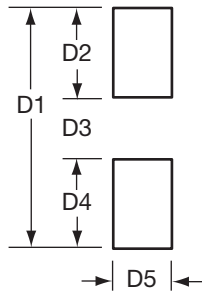

Figure 1A. 0402/0603 IR Solder Pad Layout

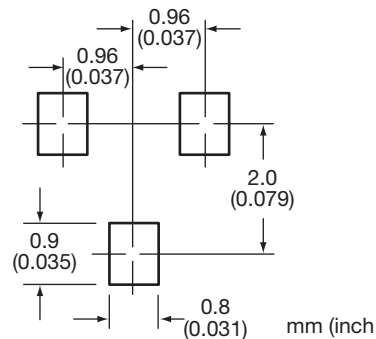

Figure 1B. SOT23- Solder Pad Layout

# AntennaGuard Series

## 0402/0603 Low Capacitance Multilayer Varistors

### ESD Protection for Antennas and Low Capacitor Loading Applications



Antenna varistors offer excellent ESD repetitive strike capability compared to a SOT23 diode when subjected to IEC 61000-4-2 8kV contact discharge. A performance summary is shown in Figure 2.

#### ESD TEST OF ANTENNAGUARD RATINGS

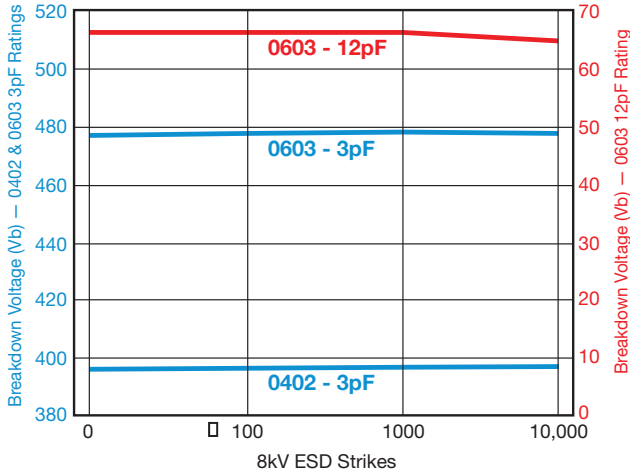

Figure 2. Repetitive 8kV ESD Strike

Antenna varistors also turn on and divert ESD overvoltages at a much faster rate than SOT23 devices (typically 300pS vs 1500pS - 5000pS). See Figure 3.

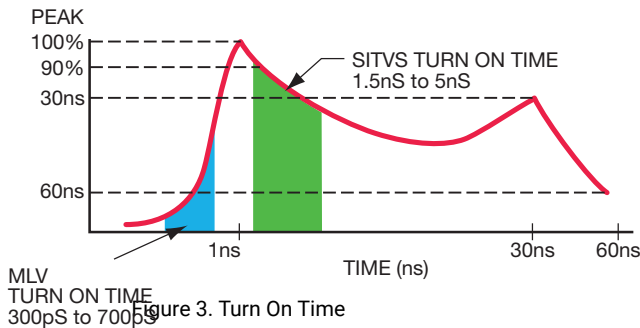

Figure 3. Turn On Time

The equivalent circuit model for a typical antenna varistor is shown in Figure 4.

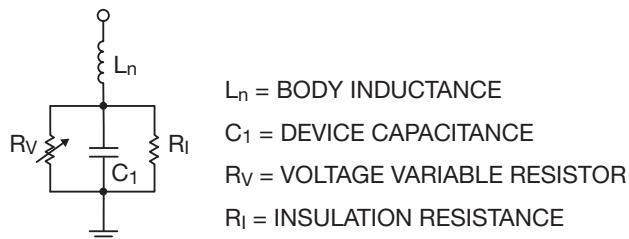

Figure 4. Antenna Varistor

The varistor shown exhibits a capacitance of  $\leq 3pF$  which can be used to replace the parallel capacitance typically found prior to the antenna output of an RF amplifier. In the off state, the varistor acts as a capacitor and helps to filter RF output. The varistor is not affected by RF output power or voltage and has little insertion loss. See Figure 3.

#### ANTENNA VARISTOR S21

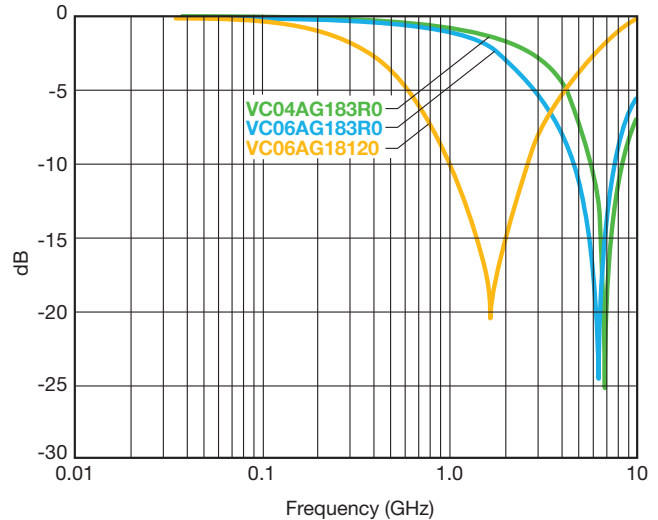

Figure 5. Antenna vs Frequency

Typical implementations of the antenna varistors are shown for use in cell phone, pager and wireless LAN applications in Figures 6A, 6B and 6C.

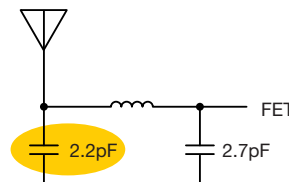

Figure 6A. Cell Phone

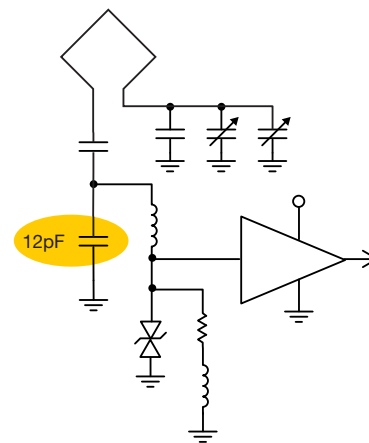

Figure 6B. Pager

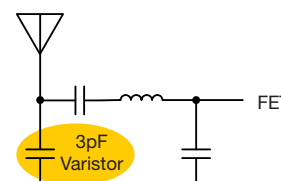
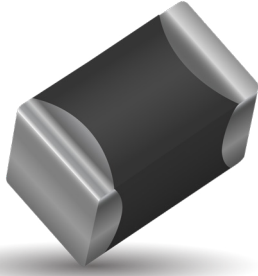

Figure 6C.

# AntennaGuard Automotive Series

## 0402/0603 Low Capacitance Automotive Varistors

### ESD Protection for Automotive Circuits Sensitive to Capacitance



### GENERAL DESCRIPTION

AVX 0402/0603 Automotive AntennaGuard products are an ultra low capacitance extension to the Automotive TransGuard® Series and are intended for use in RF and other capacitance sensitive circuits.

These low capacitance values have low insertion loss, low leakage current and unsurpassed reliability compared to diode options. These advantages combined with size advantages and bi-directional protection make the AntennaGuard the right choice for automotive applications including RF circuits, sensors, high-speed signal transmission lines, etc...



### GENERAL CHARACTERISTICS

- Operating Temperature: -55°C to +125°C
- Working Voltage: ≤18Vdc
- Case Size: 0402, 0603

### FEATURES

- AEC Q200 Qualified
- 25kV ESD rating
- Meet 27.5Vdc Jump Start requirements
- Multi-strike capability
- Sub 1nS response to ESD strike

### APPLICATIONS

- RF Circuit
- Sensors
- Antennas
- Data lines
- Keyless entry
- Capacitance sensitive applications

### HOW TO ORDER

VC	AS	06	AG	18	3R0	Y	A	T	1	A
<b>Varistor Chip</b>	<b>Series</b> AS = Automotive	<b>Case Size</b> 04 = 0402 06 = 0603	<b>Type</b>	<b>Working Voltage</b> 18 = 18.0VDC	<b>Capacitance</b> 2R0 = 2pF 3R0 = 3pF 120 = 12pF	<b>Non-Std Cap Tol</b> C = ±0.25pF (2R0) Y = Max (for 3pF) Y = +4/-2pF (for 12pF)	<b>Not Applicable</b>	<b>Termination</b> T = Ni/Sn Plated	<b>Reel Size</b> 1 = 7" reel 3 = 13" reel W = 7" reel (0402 only)	<b>Reel Qty</b> A = 4K or 10K pcs (i.e.: 1A = 4,000 3A = 10,000 WA = 10,000)

### ELECTRIAL CHARACTERISTICS

AVX Part Number	VW (DC)	VW (AC)	IL	Cap	Cap Tolerance	VJump	Case Size
VCAS04AG183R0YAT_ _	≤ 18	≤ 14	0.1	3	Max	27.5	0402
VCAS06AG182R0CAT_ _	≤ 18	≤ 14	0.1	2	±0.25pF	27.5	0603
VCAS06AG183R0YAT_ _	≤ 18	≤ 14	0.1	3	Max	27.5	0603
VCAS06AG18120YAT_ _	≤ 18	≤ 14	0.1	12	+4, -2pF	27.5	0603

Termination Finish Code  
Packaging Code

V<sub>w</sub> (DC)  
V<sub>w</sub> (AC)  
I<sub>L</sub>  
Cap  
V<sub>Jump</sub>

DC Working Voltage (V)  
AC Working Voltage (V)  
Maximum Leakage Current at the Working Voltage (µA)  
Maximum Capacitance (pF) @ 1 MHz and 0.5 Vrms; VC06AG18120YAT capacitance tolerance: +4, -2pF  
Jump Start (V)



The Important Information/Disclaimer is incorporated in the catalog where these specifications came from or available online at [www.avx.com/disclaimer/](http://www.avx.com/disclaimer/) by reference and should be reviewed in full before placing any order.

# AntennaGuard Automotive Series

## 0402/0603 Low Capacitance Automotive Varistors

### ESD Protection for Automotive Circuits Sensitive to Capacitance



#### PHYSICAL DIMENSIONS:

mm (inches)

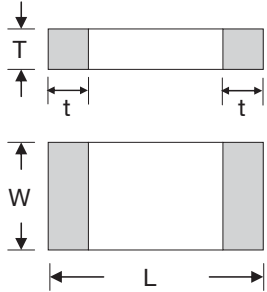

Size (EIA)	Length (L)	Width (W)	Max Thickness (T)	Land Length (t)
0402	1.00±0.10 (0.040±0.004)	0.50±0.10 (0.020±0.004)	0.60 (0.024)	0.25±0.15 (0.010±0.006)
0603	1.60±0.15 (0.063±0.006)	0.80±0.15 (0.031±0.006)	0.90 (0.035)	0.35±0.15 (0.014±0.006)

#### S21 TRANSMISSION CHARACTERISTICS

S21 Response

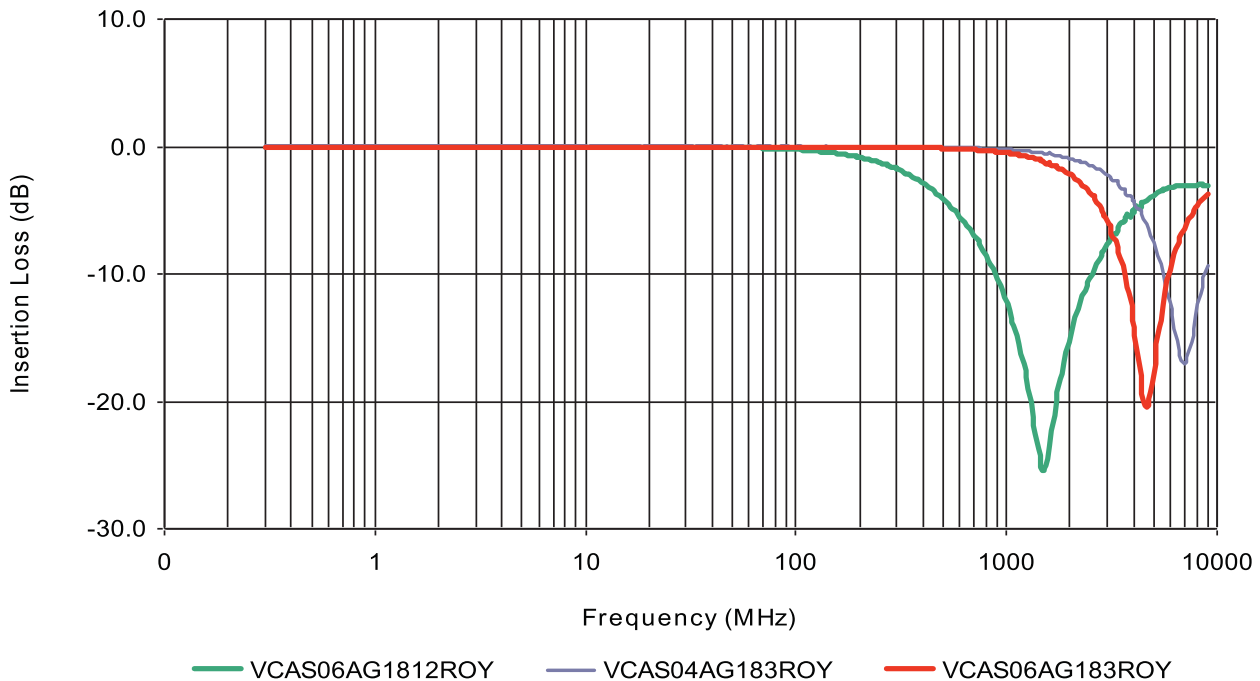

# AntennaGuard Automotive Series

## 0402/0603 Low Capacitance Automotive Varistors

### ESD Protection for Automotive Circuits Sensitive to Capacitance



#### ESD CHARACTERISTICS

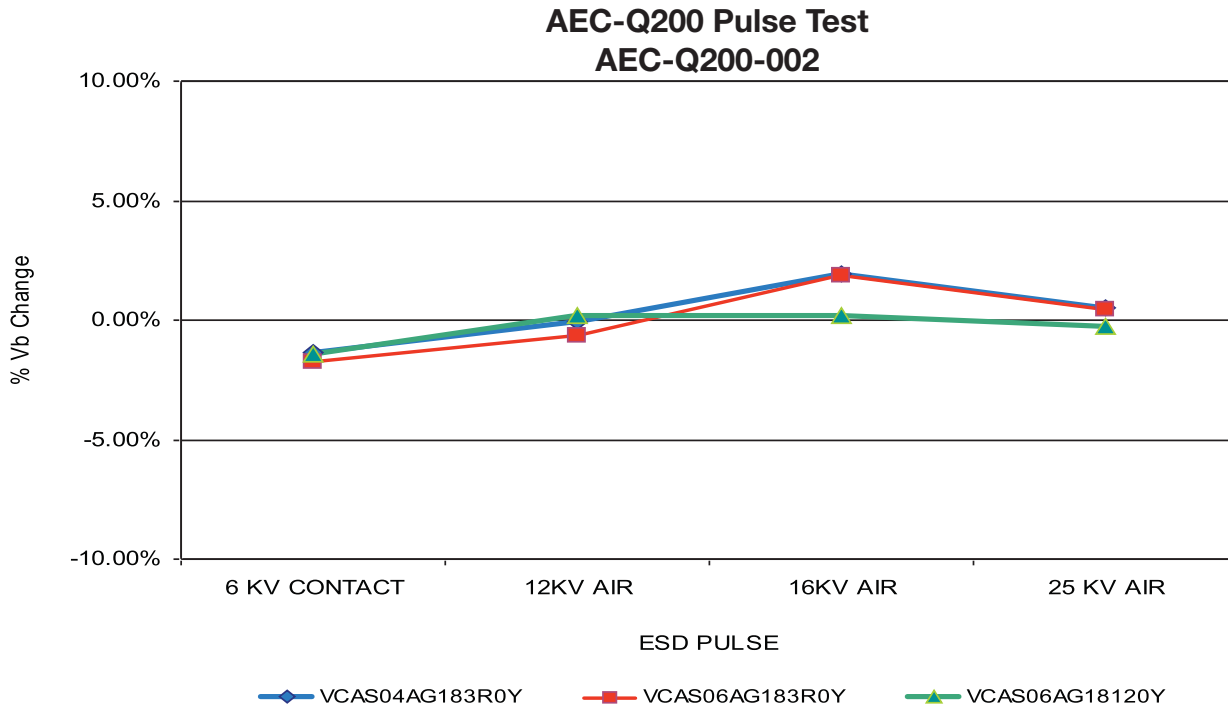

#### ELECTRICAL TRANSIENT CONDUCTION

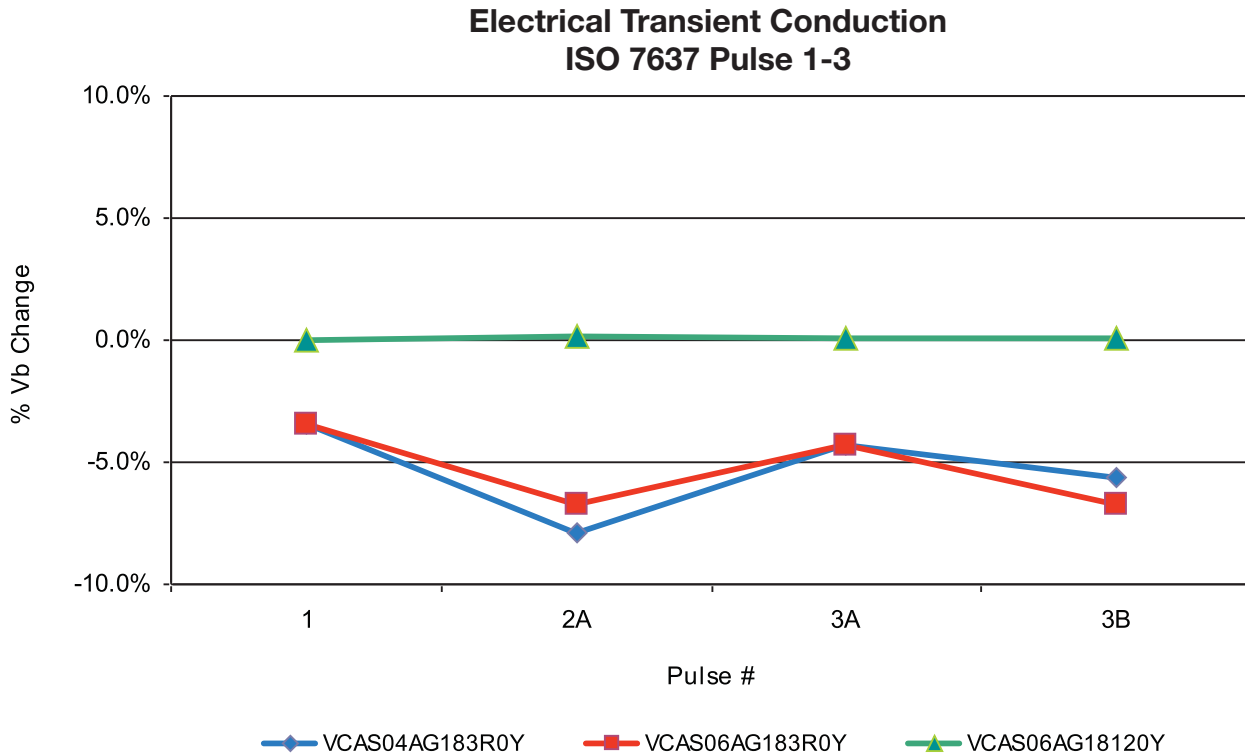

The Important Information/Disclaimer is incorporated in the catalog where these specifications came from or available online at [www.avx.com/disclaimer/](http://www.avx.com/disclaimer/) by reference and should be reviewed in full before placing any order.

# Antenna PowerGuard

## AVX Low Capacitance Varistors

### ESD Protection for Circuits Sensitive to Capacitance

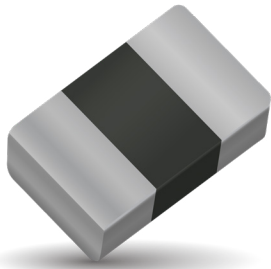

### GENERAL DESCRIPTION

AVX Antenna PowerGuard products are an ultra low capacitance extension of reliable AntennaGuard range with new voltage, capacitance and energy ratings. Designed for use in RF circuits, sensors, high-speed lines, optic circuits and capacitance sensitive applications.

The ability to handle larger transients makes the Antenna PowerGuard series useful in applications where capacitance sensitive circuit needs to be protected against higher energy and AEC-Q200 qualification allows for use in automotive applications.

These low capacitance values have low insertion loss, low leakage current and unsurpassed reliability compared to diode options. These advantages combined with size advantages and bi-directional protection make the Antenna PowerGuard the right choice for automotive and general applications, that are sensitive to capacitance.

### GENERAL CHARACTERISTICS

- Operating Temperature: -55°C to +150°C
- Case Size: 0402, 0603
- Working Voltage: 18 - 70Vdc
- Capacitance: 1.5 - 4.7pF
- Energy: 0.02 - 0.04J
- Peak Current: 1 - 3A

### FEATURES

- AEC-Q200 Qualified
- 25kV ESD rating
- Meet 48Vdc Jump Start requirements
- Multi-strike capability
- Sub 1nS response to ESD strike

### APPLICATIONS

- RF Circuit
- Sensors
- Antennas
- Data lines
- Radars
- Bluetooth
- Ethernet (IEEE 802.3bw and IEEE 802.3bp) VCAS06AP303R3LAT

AVX is an adopting member of the OPEN Alliance to collaborate with other technology providers and the customers to further develop and standardize Ethernet-based networks in Automotive applications.

The following parts are fully compliant and qualified for OPEN Alliance Ethernet standards:

- 1000BASE-T1 Ethernet: VCAS04AP701R5YATWA
- 100BASE-T1 Ethernet: VCAS04AP704R7LATWA



### HOW TO ORDER

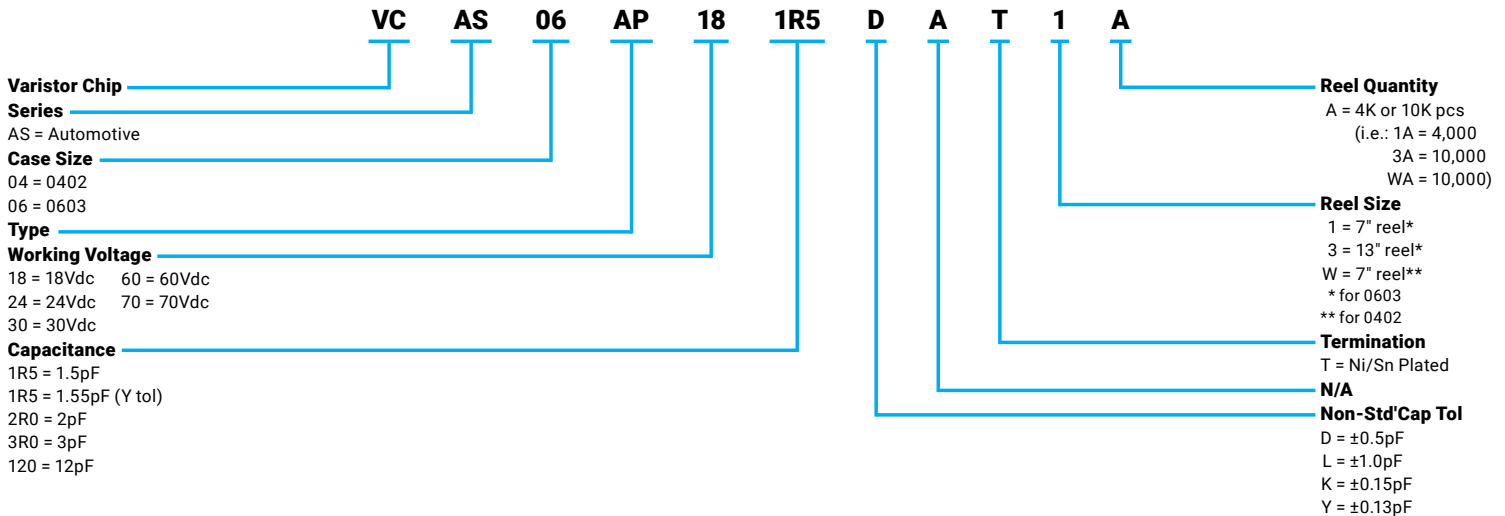

### PHYSICAL DIMENSIONS: MM (INCHES)

Size (EIA)	Length (L)	Width (W)	Max Thickness (T)	Land Length (t)
0402	1.00±0.10 (0.040±0.004)	0.50±0.10 (0.020±0.004)	0.60 (0.024)	0.25±0.15 (0.010±0.006)
0603	1.60±0.15 (0.063±0.006)	0.80±0.15 (0.031±0.006)	0.90 (0.035)	0.35±0.15 (0.014±0.006)

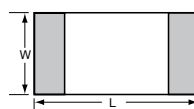
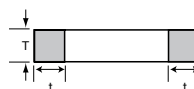

# Antenna PowerGuard

## AVX Low Capacitance Varistors

### ESD Protection for Circuits Sensitive to Capacitance



## ELECTRIAL CHARACTERISTICS

AVX Part Number	V <sub>w</sub> (DC)	V <sub>w</sub> (AC)	V <sub>B</sub>	V <sub>C</sub>	I <sub>L</sub>	E <sub>T</sub>	I <sub>P</sub>	Cap	Cap Tolerance	V <sub>Jump</sub>	Case Size
VCAS04AP181R5KAT	18	14	150-210	350	0.1	0.02	1	1.5	±0.15pF	48	0402
VCAS04AP181R5DAT	18	14	150-210	350	0.1	0.02	1	1.5	±0.5pF	48	0402
VCAS04AP181R5YAT	18	14	150-210	350	0.1	0.02	1	1.55	±0.13pF	48	0402
VCAS04AP182R0LAT	18	14	80-140	300	0.1	0.02	1	2.0	±1.0pF	48	0402
VCAS06AP181R5DAT	18	14	150-200	375	0.1	0.02	1	1.5	±0.5pF	48	0603
VCAS06AP182R0LAT	18	14	150-200	350	0.1	0.03	2	2.0	±1.0pF	48	0603
VCAS06AP243R3LAT	24	17	90-150	240	0.1	0.04	3	3.3	±1.0pF	48	0603
VCAS04AP301R5KAT	30	21	150-210	350	0.1	0.02	1	1.5	±0.15pF	48	0402
VCAS04AP301R5DAT	30	21	150-210	350	0.1	0.02	1	1.5	±0.5pF	48	0402
VCAS04AP301R5YAT	30	21	150-210	350	0.1	0.02	1	1.55	±0.13pF	48	0402
VCAS06AP302R0LAT	30	21	150-200	350	0.1	0.03	2	2.0	±1.0pF	48	0603
VCAS06AP303R3LAT	30	21	90-150	240	0.1	0.04	3	3.3	±1.0pF	48	0603
VCAS04AP601R5DAT	60	42	150-210	350	0.1	0.02	1	1.5	±0.5pF	48	0402
VCAS06AP602R0LAT	60	42	150-200	350	0.1	0.03	2	2.0	±1.0pF	48	0603
VCAS04AP701R5KAT	70	52	150-210	350	0.1	0.02	1	1.5	±0.15pF	48	0402
VCAS04AP701R5DAT	70	52	150-210	350	0.1	0.02	1	1.5	±0.5pF	48	0402
VCAS04AP701R5YAT	70	52	150-210	350	0.1	0.02	1	1.55	±0.13pF	48	0402
VCAS04AP704R7LAT	70	52	90-110	190	1	0.03	1	4.7	±1pF	48	0402

V<sub>w</sub> (DC) DC Working Voltage [V] VB

V<sub>w</sub> (AC) AC Working Voltage [V]

V<sub>B</sub> Breakdown Voltage [V @ 1mA<sub>DC</sub>]

V<sub>C</sub> Clamping Voltage [V @ 1A]

I<sub>L</sub> Maximum leakage current at the working voltage [μA]

E<sub>T</sub> Transient Energy Rating [J, 10x1000μS]

I<sub>P</sub> Peak Current Rating [A, 8x20μS]

Cap Capacitance [pF] @ 1MHz specified and 0.5VRMS

Cap Tol Capacitance tolerance (pF) from Typ value

V<sub>Jump</sub> Jump Start (V, 5min)



# Antenna PowerGuard

## AVX Low Capacitance Varistors

### ESD Protection for Circuits Sensitive to Capacitance



#### V/I CHARACTERISTICS

#### S21 CHARACTERISTICS

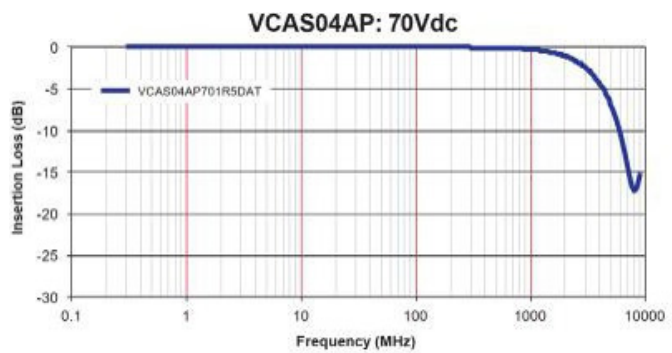
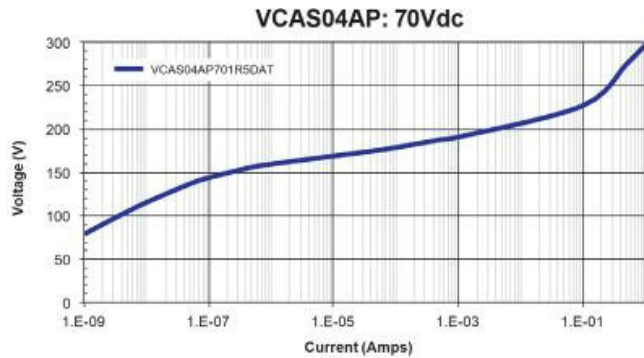
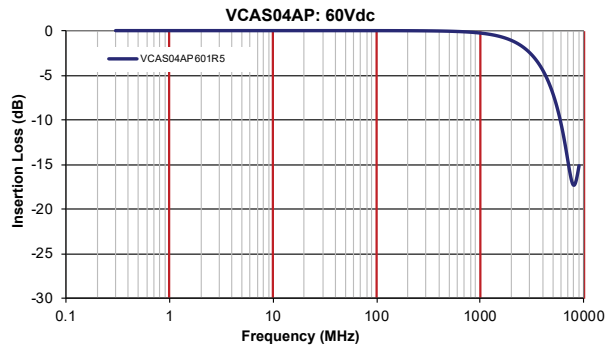
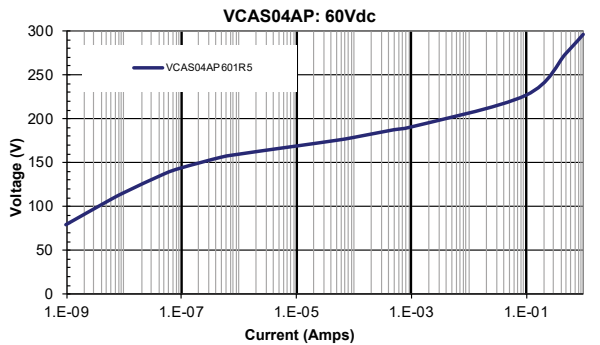
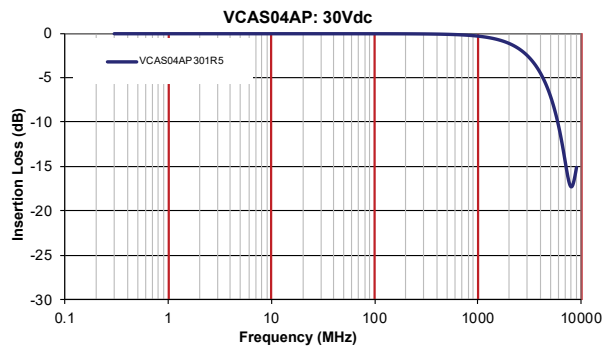
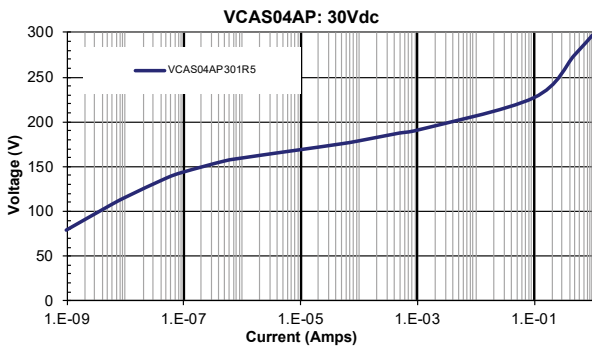
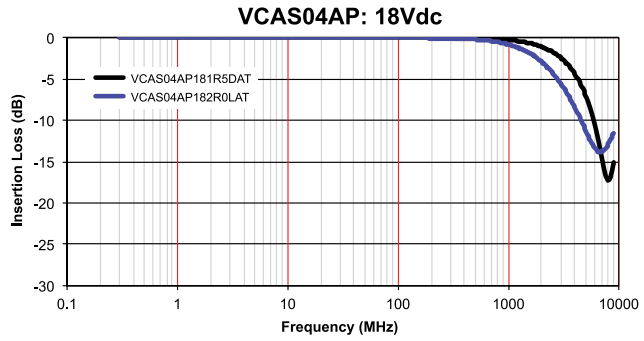
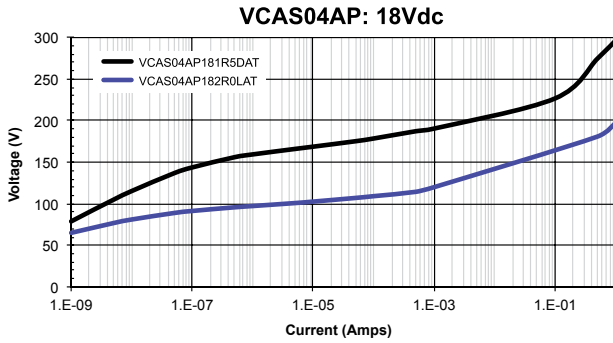

# Antenna PowerGuard

## AVX Low Capacitance Varistors

### ESD Protection for Circuits Sensitive to Capacitance



#### V/I CHARACTERISTICS

#### S21 CHARACTERISTICS

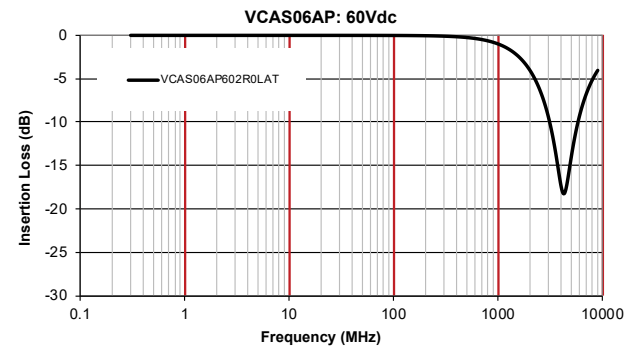
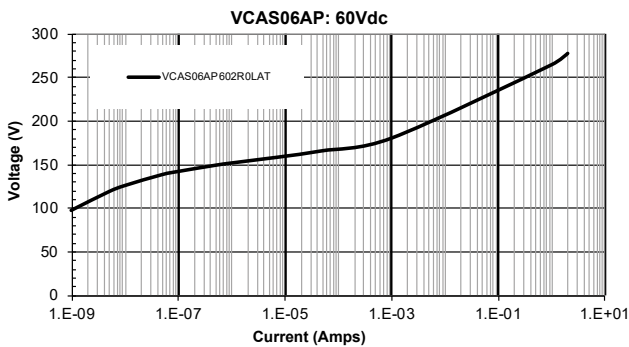
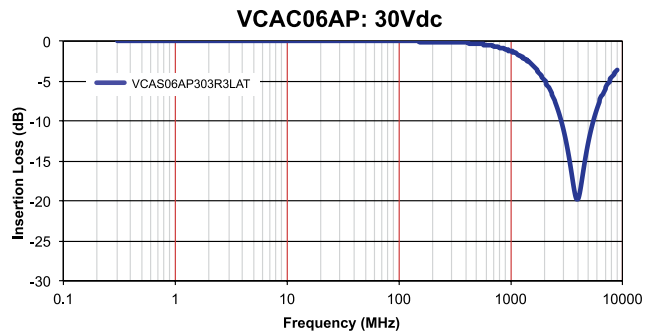
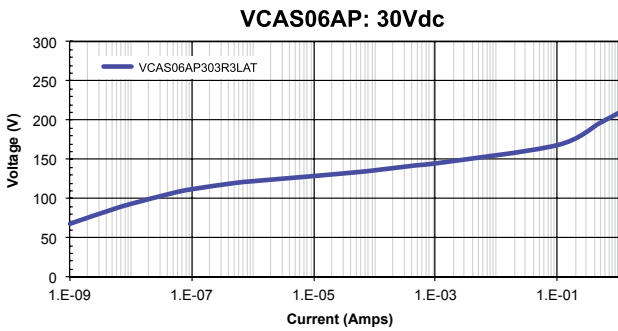
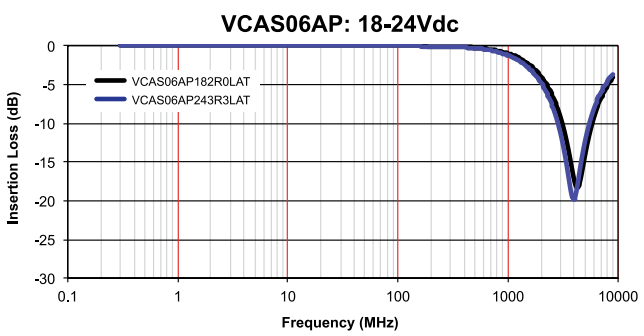
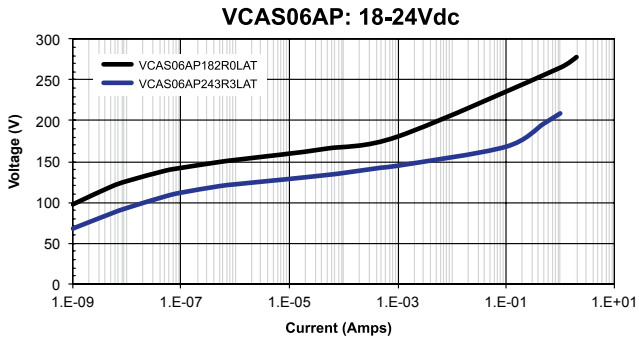
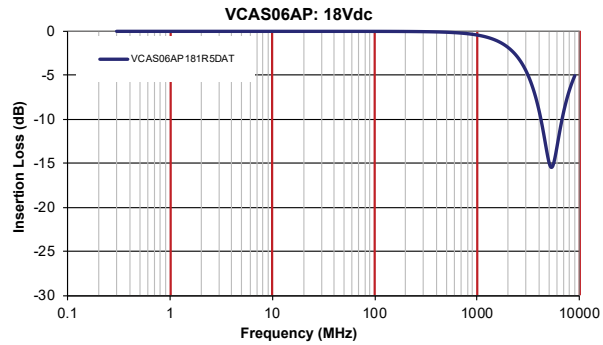
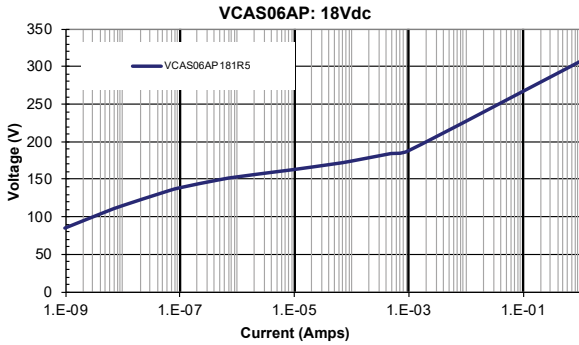

# Antenna PowerGuard

## AVX Low Capacitance Varistors

### ESD Protection for Circuits Sensitive to Capacitance



#### ESD CHARACTERISTIC

8kV ESD Vc Wave Capture  
(150pF/330ohm Network)

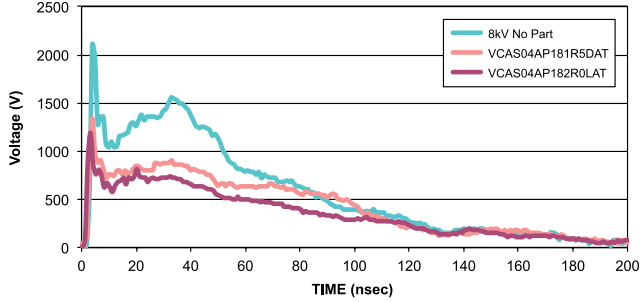

8kV ESD Vc Wave Capture  
(150pF/330ohm Network)

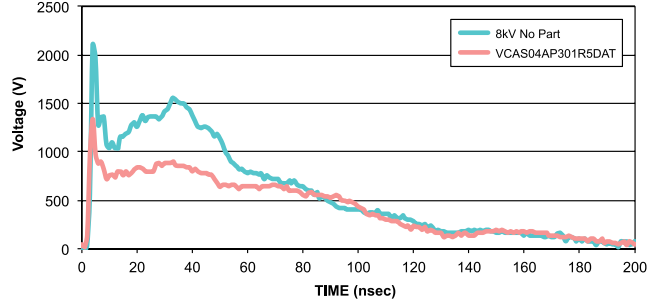

15kV ESD Vc Wave Capture  
(150pF/330ohm Network)

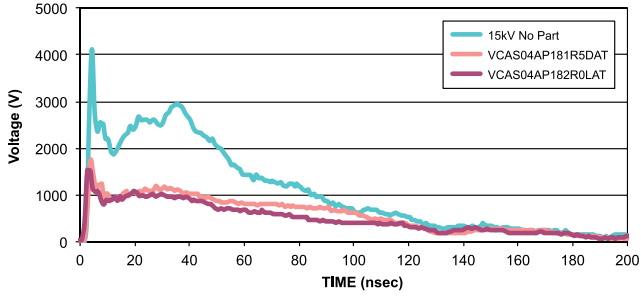

15kV ESD Vc Wave Capture  
(150pF/330ohm Network)

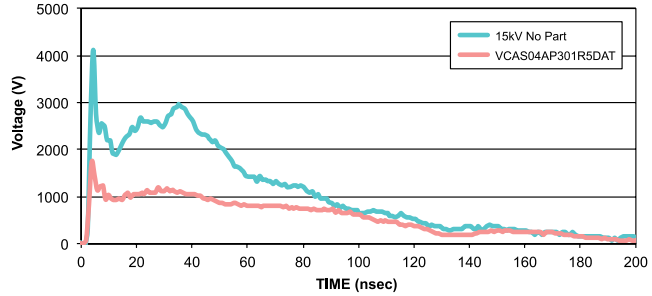

8kV ESD Vc Wave Capture  
(150pF/330ohm Network)

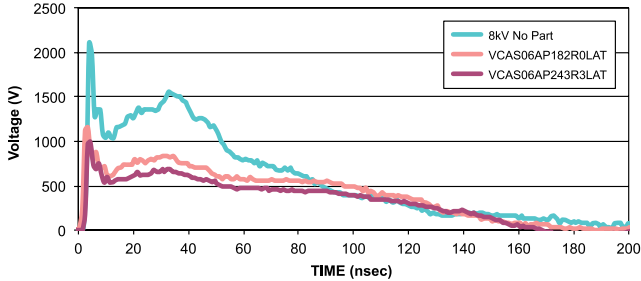

8kV ESD Vc Wave Capture  
(150pF/330ohm Network)

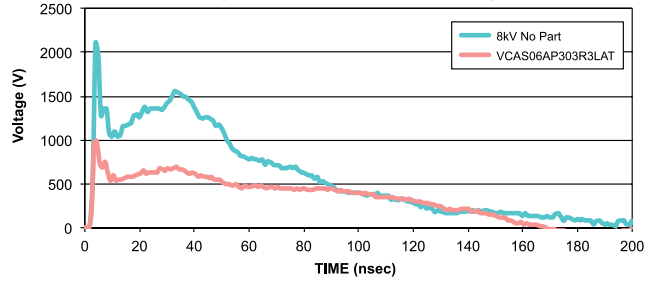

15kV ESD Vc Wave Capture  
(150pF/330ohm Network)

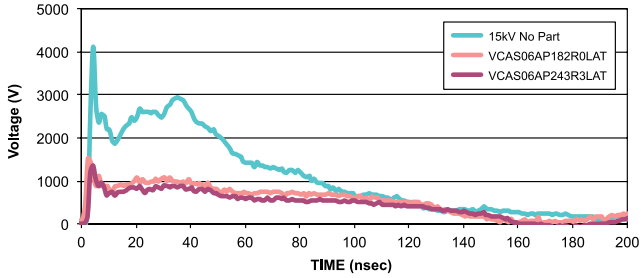

15kV ESD Vc Wave Capture  
(150pF/330ohm Network)

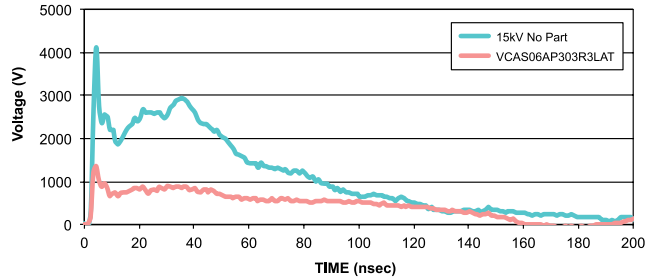

# AntennaGuard® Series Sub pF

## Ultra-low Capacitance Multilayer Varistors

### ESD Protection for any Circuit Sensitive to Capacitance



#### GENERAL DESCRIPTION

AVX offers ultra-low capacitance ESD protection in the Sub 1pF range for use in circuits that are sensitive to capacitance. The Sub pF Varistor (SPV) is available in 0.8pF and 0.4pF capacitance values in a compact 0402 low profile package. SPV devices provide excellent response time to ESD strikes to protect sensitive circuits from over voltage conditions.

The development of new information processing technologies call for ever increasing digital system speeds. Higher speeds necessitate the use of ultra-low capacitance values in order to minimize signal distortion.

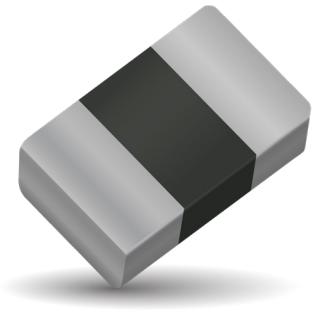

#### FEATURES

- High Reliability
- Capacitance <1pF
- Bi-Directional protection
- Fastest response time to ESD strikes
- Multi-strike capability
- Low insertion loss
- Low profile 0402 case size

#### APPLICATIONS

- Antennas
- Optics
- HDMI
- RF circuits
- FlexRay
- Portable devices
- Analog sensors
- Any circuit sensitive to capacitance

#### HOW TO ORDER

<b>VC</b> T <b>Varistor Chip</b>	<b>H4</b> T <b>Chip Size</b> H2 = 0201 H4 = Thin 0402	<b>AG</b> T <b>Varistor Series</b> AntennaGuard	<b>10</b> T <b>Working Voltage</b> 10 = 10V 15 = 15V 18 = 18V	<b>0R8</b> T <b>Capacitance</b> 0R8 = 0.8pF 0R7 = 0.7pF 0R4 = 0.47pF	<b>M</b> T <b>Tolerance</b> M = ±20%	<b>A</b> T <b>N/A</b>	<b>T</b> T <b>Termination</b> T = Ni/Sn	<b>W</b> T <b>Reel Size</b> W = 7"	<b>A</b> T <b>Reel Quantity</b> A = 10k
--	---	--	--	---	---	-----------------------------	--	---	--

#### ANTENNAGUARD CATALOG PART NUMBERS/ELECTRICAL VALUES

AVX Part Number	V <sub>w</sub> (DC)	V <sub>B</sub>	I <sub>L</sub>	Cap	Cap Tolerance	3db Freq (MHz)	Case Size
VCH4AG100R8MA	≤10	125	<10 nA	0.8	±20%	5800	LP 0402
VCH4AG150R8MA	≤15	125	<10 nA	0.8	±20%	5800	LP 0402
VCH4AG150R4MA	≤15	135	<100 nA	0.47	±20%	6700	LP 0402
VCH2AG180R7MA	≤18	135	<5μA	0.7	±20%	10800	0201

- V<sub>w</sub> (DC) DC Working Voltage (V)
- V<sub>B</sub> Typical Breakdown Voltage (V @ 1mADC)
- I<sub>L</sub> Typical leakage current at the working voltage
- Cap Typical capacitance (pF) @ frequency specified and 0.5VRMS
- Freq Frequency at which capacitance is measured (M = 1MHz)



# AntennaGuard® Sub pF

## Ultra-low Capacitance Multilayer Varistors

### ESD Protection for any Circuit Sensitive to Capacitance



### S21 TRANSMISSION CHARACTERISTICS -SPV V/I CURVE - SPV

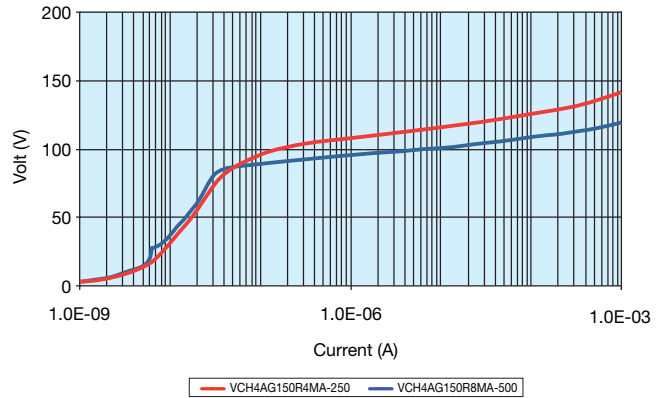
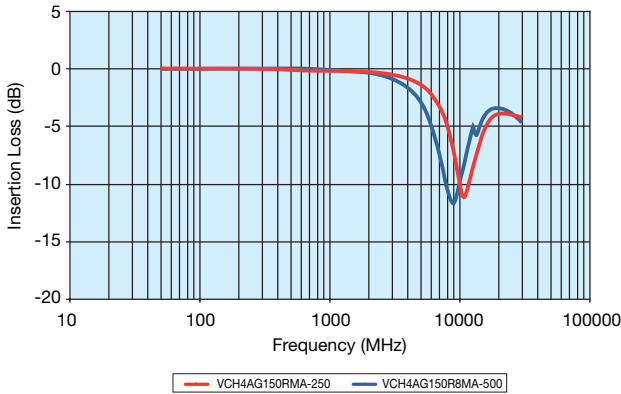

### ESD WAVE ABSORPTION CHARACTERISTICS

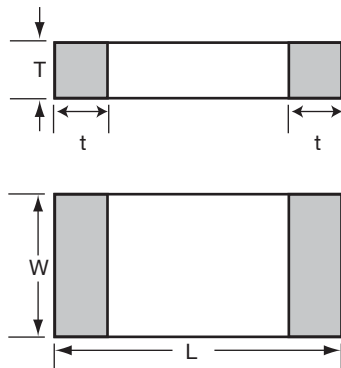
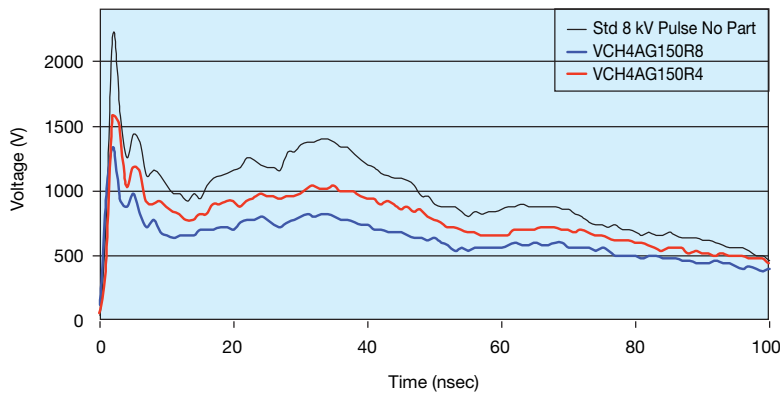

mm (inches)	
Size (EIA)	0402
Length (L)	1.00 ±0.10 (0.040 ± 0.004)
Width (W)	0.50 ±0.10 (0.020 ±0.004)
Max Thickness (T)	0.35 (0.014)
Terminal (t)	0.25±0.15 (0.010±0.006)

# AntennaGuard Automotive Series Sub pF

## Ultra-low Capacitance Automotive Varistor for ESD Protection for Automotive Circuits Sensitive to Capacitance



### GENERAL DESCRIPTION

AVX offers ultra-low capacitance ESD protection in the Sub 1pF range for use in automotive circuits that are sensitive to capacitance. The Automotive Sub pF Varistor (ASPV) is available in 0.8pF capacitance value in a compact 0402 low profile package. ASPV devices provide excellent response time to ESD strikes to protect sensitive circuits from over voltage.

The development of new information processing technologies call for ever increasing digital system speeds. Higher speeds necessitate the use of ultra-low capacitance values in order to minimize signal distortion.

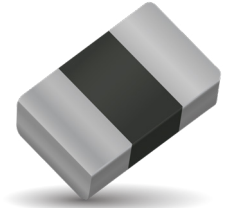

### GENERAL CHARACTERISTICS

- Operating Temperature: -55°C to +125°C
- Working Voltage: 16Vdc
- Case Size: 0402 low profile
- Capacitance < 1pF

### FEATURES

- High Reliability
- Capacitance <1pF
- Bi-Directional protection
- Fastest response time to ESD strikes
- Multi-strike capability
- Low insertion loss
- Low profile 0402 case size
- AEC-Q 200 Qualified

### APPLICATIONS

- Antennas, RF circuits
- Optics
- HDMI, Firewire, Thunderbolt
- High speed communication bus
- GPS
- Camera link
- Sensors
- Touch screen interfaces
- Circuits sensitive to capacitance

### HOW TO ORDER

<b>VC</b>   Varistor Chip	<b>AS</b>   Automotive Series	<b>H4</b>   Chip Size Low Profile 0402	<b>AG</b>   Varistor Series AG Series Ultra-low Capacitance	<b>16</b>   Working Voltage 16 = 16V	<b>0R8</b>   Capacitance 0R8 = 0.8pF	<b>M</b>   Tolerance M = ±20%	<b>A</b>   N/A	<b>T</b>   Termination T = Ni Barrier/ 100% Sn	<b>W</b>   Reel Size W = 7"	<b>A</b>   Reel Quantity A = 10k
---------------------------------	-------------------------------------	--	---	---	---	--	----------------------	--	--------------------------------------	---

### ANTENNAGUARD CATALOG PART NUMBERS/ELECTRICAL VALUES

AVX Part Number	V <sub>w</sub> (DC)	V <sub>B</sub>	I <sub>L</sub>	Cap	Cap Tolerance	3db Freq (MHz)	Case Size
VCASH4AG160R8MA	≤16	125	1	0.8	±20%	5800	LP 0402

V <sub>w</sub> (DC)	DC Working Voltage (V)
V <sub>B</sub>	Typical Breakdown Voltage (V @ 1mA DC)
I <sub>L</sub>	Typical leakage current at the working voltage
Cap	Typical capacitance (pF) @ frequency specified and 0.5V <sub>RMS</sub>
Freq	Frequency at which capacitance is measured (M = 1MHz)



# AntennaGuard Automotive Series Sub pF

## Ultra-low Capacitance Automotive Varistor for ESD Protection for Automotive Circuits Sensitive to Capacitance



### S21 TRANSMISSION CHARACTERISTICS -SPV V/I CURVE - SPV

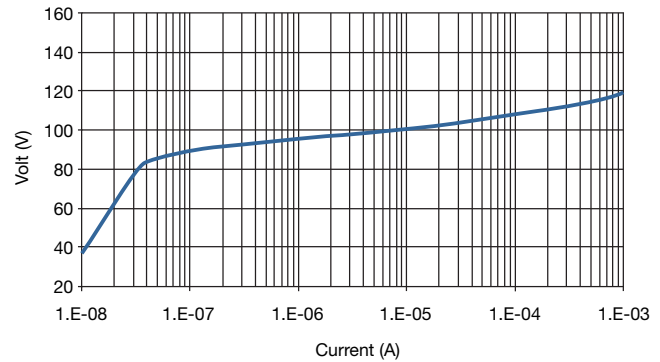
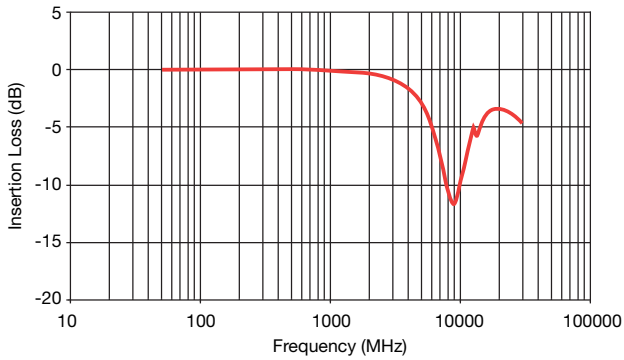

### DIMENSIONS

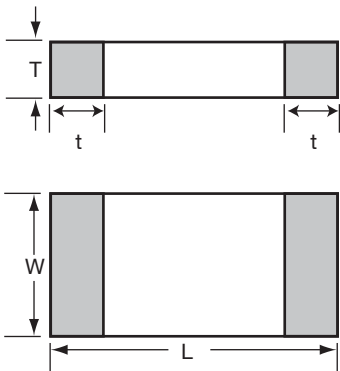

mm (inches)

Size (EIA)	0402
Length (L)	1.00 ± 0.10 (0.040 ± 0.004)
Width (W)	0.50 ± 0.10 (0.020 ± 0.004)
Max Thickness (T)	0.35 (0.014)
Terminal (t)	0.25 ± 0.15 (0.010 ± 0.006)

# AntennaGuard Automotive Series Sub pF

## Ultra-low Capacitance Automotive Varistor for ESD Protection for Automotive Circuits Sensitive to Capacitance



### EYE DIAGRAM - USB-HS (480MHZ) TEST

No Part

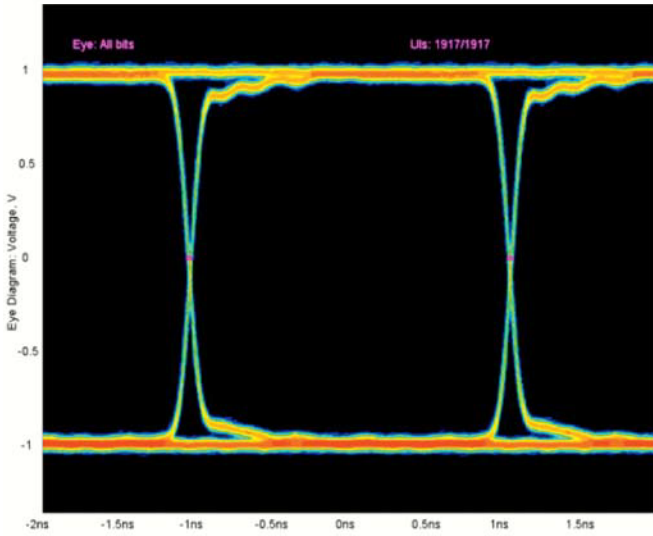

VCASH4AG160R8MATWA

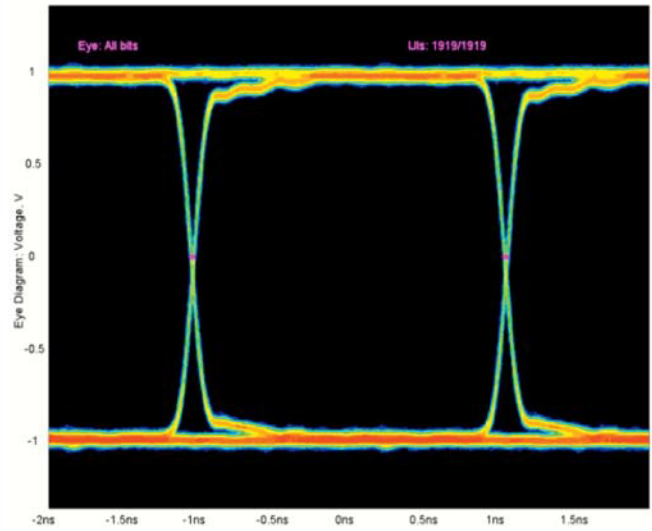

### EYE DIAGRAM - PCI-E (2.5GHZ) TEST

No Part

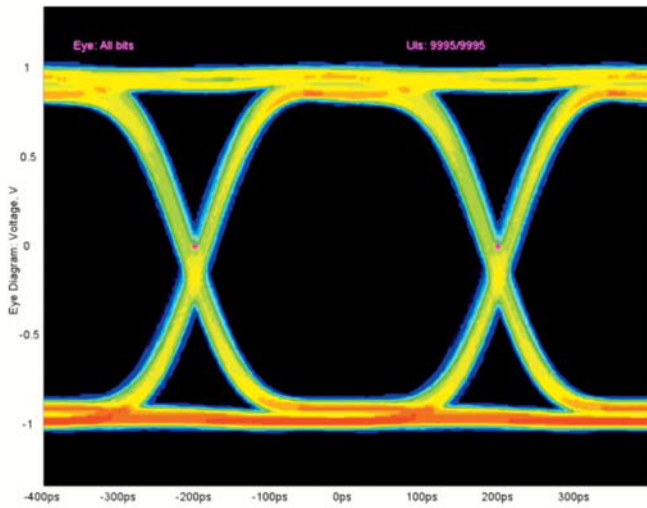

VCASH4AG160R8MATWA

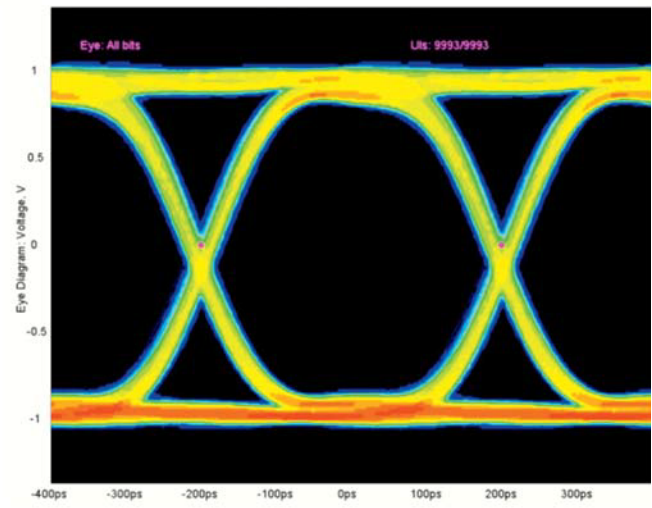



# Controlled Capacitance Multilayer Varistor

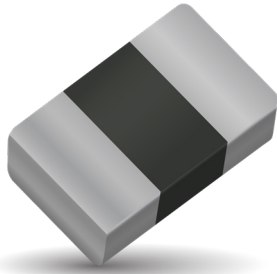

## GENERAL DESCRIPTION

The Controlled Capacitance TransGuard is an application specific bi-directional transient voltage suppressor developed for use in mixed signal environments. The Controlled Cap MLV has three purposes: 1) reduce emissions from a high speed ASIC, 2) prevent induced E fields from conducting into the IC, and 3) clamp transient voltages. By controlling capacitance of the MLV, the center frequency and 20db range for filtering purposes can be targeted. A Controlled Cap MLV can greatly improve overall system EMC performance and reduce system size.

## GENERAL CHARACTERISTICS

- Operating Temperature: -55°C to +125°C
- Working Voltage: 9 - 30Vdc
- Case Size: 0402, 0603

## FEATURES

- Single Chip Solution
- Targeted EMI/RFI Filtering
- 20dB Range for filtering purposes
- Improves system EMC performance
- Very fast response to ESD
- 25kV ESD

## APPLICATIONS

- EMI TVS Module Control
- High Speed ASICS
- Mixed Signal Environment
- Sensors and more

## HOW TO ORDER

<b>VCAC</b> Varistor Chip Automotive Capacitance	<b>0603</b> Chip Size 0402 0603	<b>22</b> Working Voltage 09 = 9V 17 = 17V 22 = 22V 26 = 26V 30 = 30V	<b>A</b> Energy Rating X = 0.05J A = 0.1J B = 0.2J C = 0.3J	<b>470</b> Capacitance 15 = 15pF 330 = 33pF 380 = 38pF 470 = 47pF 820 = 82pF 102 = 1000pF	<b>N</b> Tolerance N = ±30% M = ±20%	<b>R</b> Packaging R = 4k pcs D = 7" reel (1,000 pcs) R = 7" reel (4,000 pcs) T = 13" reel (10,000 pcs) W = 7" Reel (10,000 pcs 0402 only)	<b>P</b> Termination P = Ni Barrier/ 100% Sn (matte)
---	--	--	---	--	---	---	---



AVX Part Number	VW (DC)	VW (AC)	VB	VC	IL	ET	IP	Cap	Cap Tolerance	Case Size
VCAC060309B102N	9.0	6.4	12.7±15%	22	25	0.2	120	1000	±30%	0603
VCAC060317X150N	17	12	27±20%	52	10	0.05	2	15	±30%	0603
VCAC060317X330M	17	12	27±20%	52	10	0.05	2	33	±20%	0603
VCAC060322A470N	22	17	32.5±25%	50	10	0.1	30	47	30%	0603
VCAC060326C820M	26	20	36.0±15%	67	10	0.3	30	82	20%	0603
VCAC040230X380N	30	21	41±10%	67	5	0.05	10	38	±30%	0402

VW(DC)	DC Working Voltage [V]	$I_L$	Maximum leakage current at the working voltage, 25°C [µA]
VW(AC)	AC Working Voltage [V]	$E_T$	Transient Energy Rating [J, 10x1000µS]
VB	Breakdown Voltage [V @ 1mADC]	$I_p$	Peak Current Rating [A, 8x20µS]
VC	Clamping Voltage [V @ 1A]	Cap	Capacitance [pF] @ 1KHz specified and 0.5VRMS, 25°C

## 0603 DISCRETE DIMENSIONS

mm (inches)

Size (EIA)	Length (L)	Width (W)	Max Thickness (T)	Land Length (t)
0402	1.00±0.10 (0.040±0.004)	0.50±0.10 (0.020±0.004)	0.60 (0.024)	0.25±0.15 (0.010±0.006)
0603	1.60±0.15 (0.063±0.006)	0.80±0.15 (0.031±0.006)	0.90 (0.035)	0.35±0.15 (0.014±0.006)

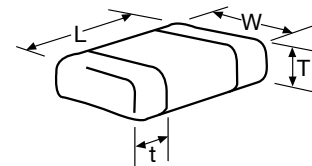

## V-I Curve

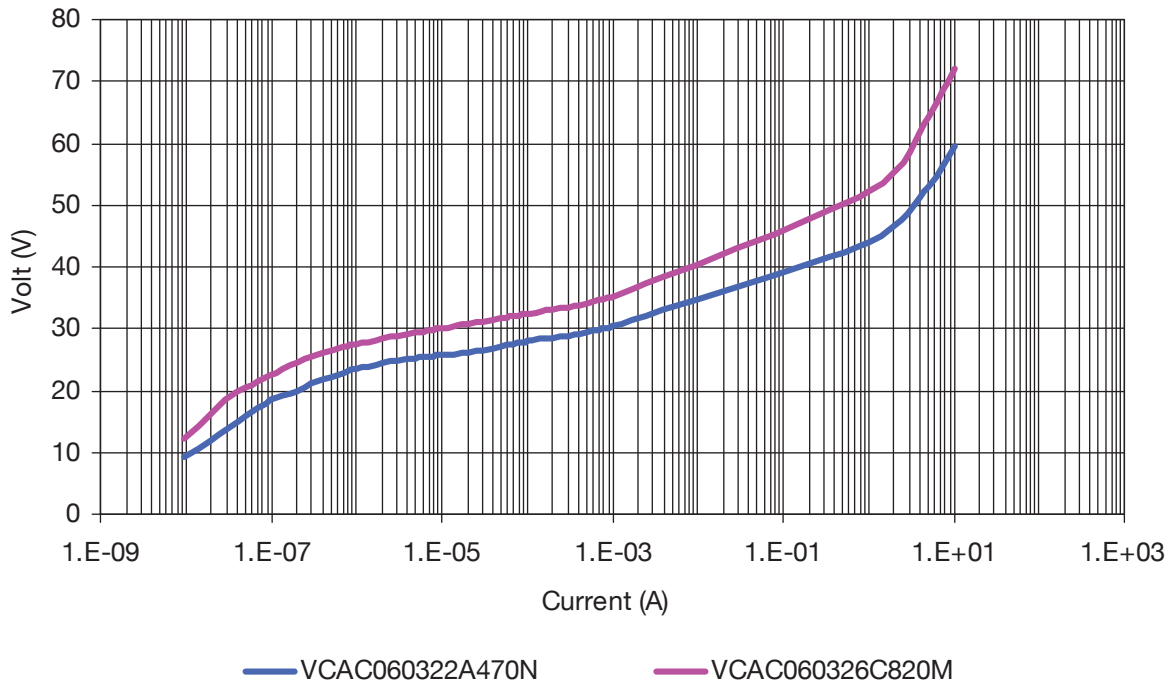

## S21

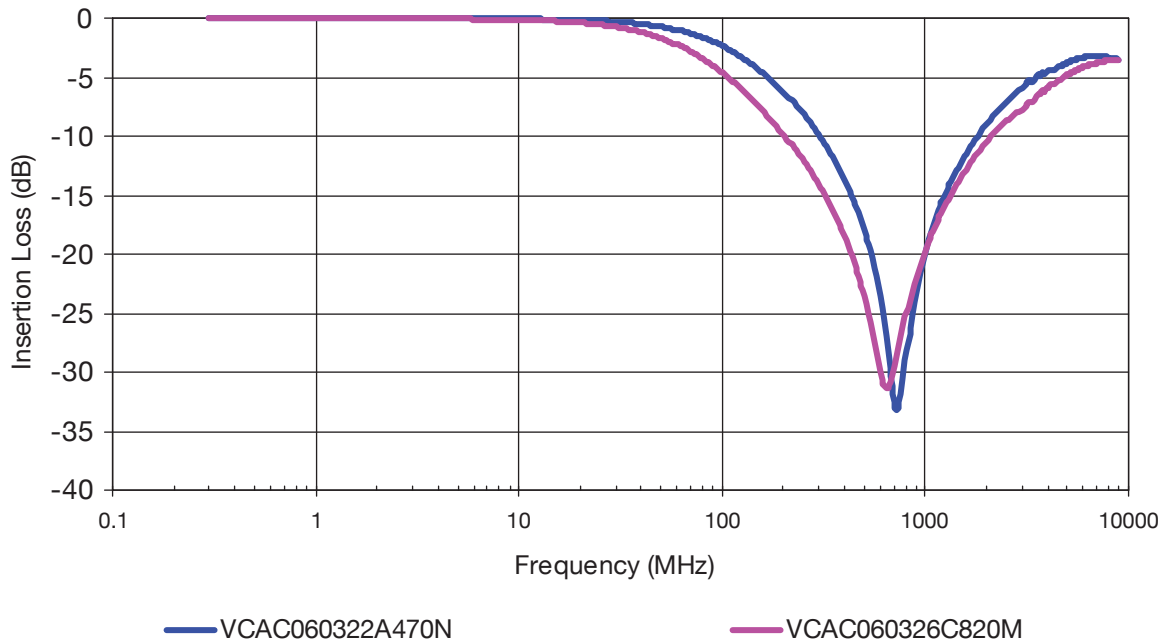

# Miniature AC Varistor – MAV

## Low Power AC and Low Capacitance DC Circuit Protection



### GENERAL DESCRIPTION

AVX Miniature AC Varistors are designed for use in low power AC circuit protection. MAV series devices are an ideal solution to transient suppression in LC resonant circuits intended for signal & power transfer. The AVX part provides low loss in the resonant circuit yet is able to clamp large amounts of transients in a bi-directional manner.

The ability to handle large transients makes the MAV series useful in low power AC circuit protection and the AEC Q200 qualification allows for use in automotive applications.

Low capacitance makes these parts useful also for higher DC voltage data lines and other capacitance sensitive applications.

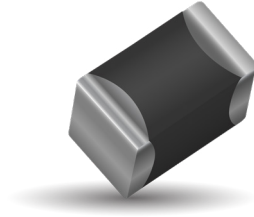

### GENERAL CHARACTERISTICS

- Operating Temperature: -55 to +125°C
- Working Voltage: 70Vdc / 52Vac
- Case Size: 0402, 0603, 0405 2xArray

### FEATURES

- 110 Pk-Pk @ 125kHz capability
- AEC Q200 qualified
- ESD rated to 25kV (HBM ESD Level 6)
- EMI/RFI attenuation in off state
- Bi-Directional protection

### APPLICATIONS

- LC resonant circuits
- AC sampling circuitry
- Transformer secondaries
- GFI modules
- Immobilizers
- Keyless entry
- Data lines
- Capacitance sensitive applications and more

### HOW TO ORDER

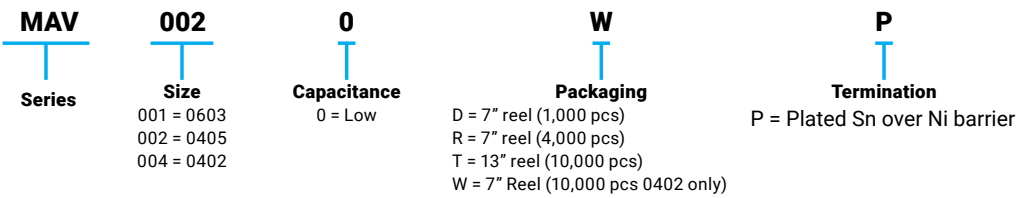

### ANTENNAGUARD CATALOG PART NUMBERS/ELECTRICAL VALUES

AVX Part Number	VW (DC)	VW (AC)	VB	VC	IVC	ET	IP	IL	Cap	Elements
MAV0010_P	70	52	120 ±15%	225	1	0.015	2	10	22pF Max	1
MAV0020_P	70	52	120 ±15%	225	1	0.020	3	10	8pF Max	2
MAV0040_P	70	52	120 ± 15%	225	1	0.020	1	10	6pF Max	1

└─ Packaging Code

$V_w$ (DC)	DC Working Voltage [V]	$I_L$	Maximum leakage current at the working voltage [ $\mu$ A]
$V_w$ (AC)	AC Working Voltage [V]	$E_T$	Transient Energy Rating [J, 10x100 $\mu$ S]
$V_B$	Breakdown Voltage [V @ 1mA <sub>DC</sub> ]	$I_P$	Peak Current Rating [A, 8x10 $\mu$ S]
$V_C$	Clamping Voltage [V @ IVC]	Cap	Maximum capacitance @ 1MHz and 0.5V <sub>RMS</sub>

# Miniature AC Varistor – MAV

## Low Power AC and Low Capacitance DC Circuit Protection



### TYPICAL PERFORMANCE CURVES

Voltage/Current Characteristics

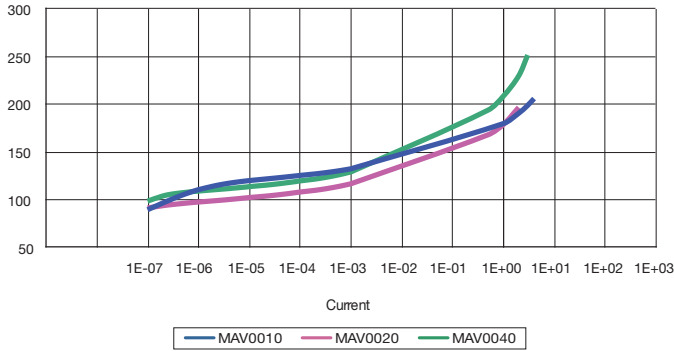

Transmission Characteristics

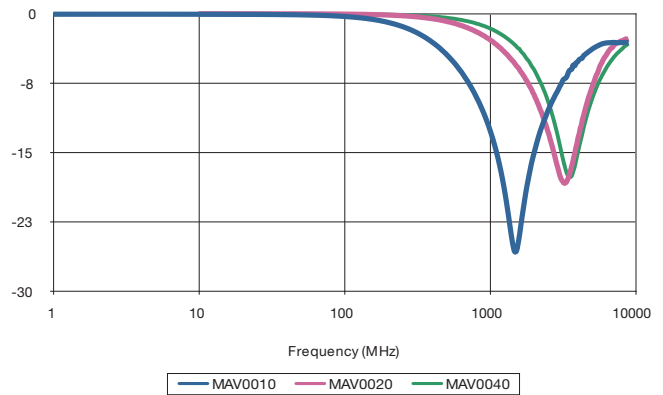

### TYPICAL PERFORMANCE CURVES

Impact of AC Voltage on Breakdown Voltage  
Parallel 110VPP @ 125 kHz

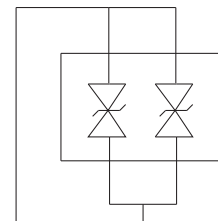
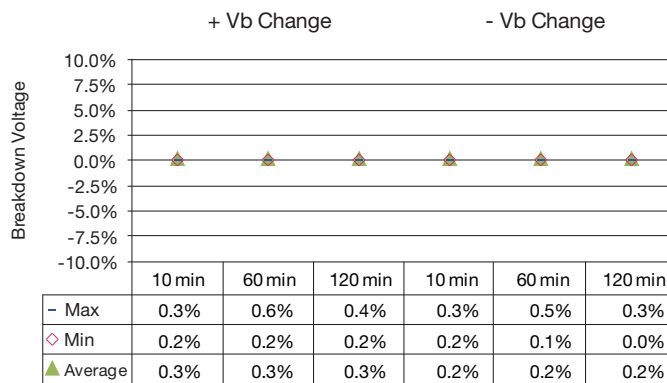

Apply 110V pp  
125KHz Sine wave  
(Parallel)

Impact of AC Voltage on Breakdown Voltage  
Series 110VPP @ 125 kHz

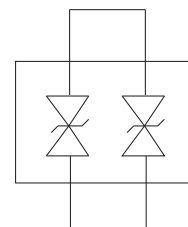
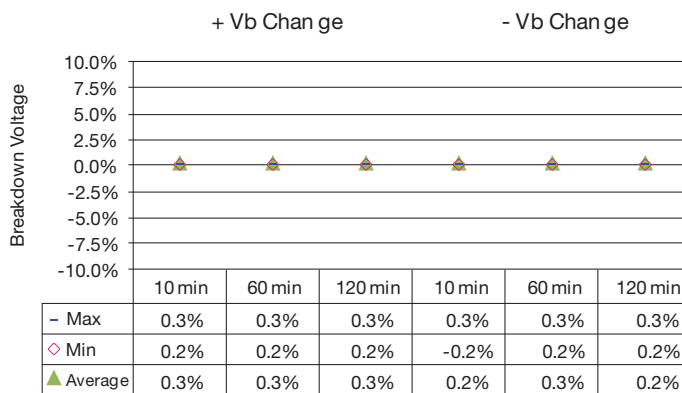

Apply 110V pp  
125KHz Sine wave  
(Series)



# Miniature AC Varistor – MAV

## Low Power AC and Low Capacitance DC Circuit Protection

### IMPACT OF AC VOLTAGE ON LEAKAGE CURRENT

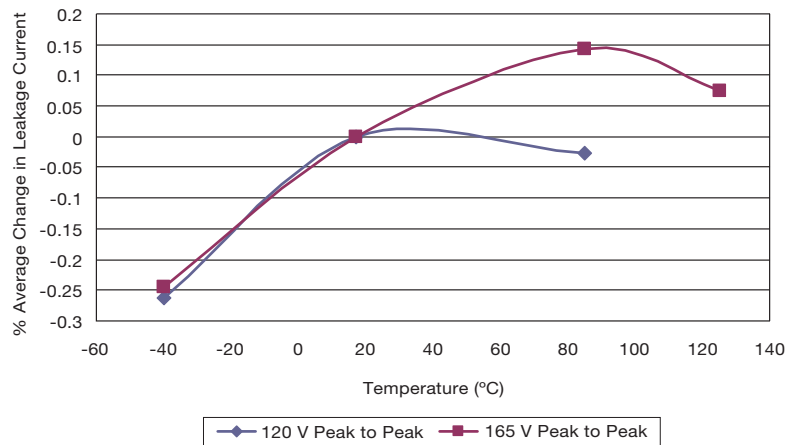

### PHYSICAL DIMENSIONS AND RECOMMENDED PAD LAYOUT

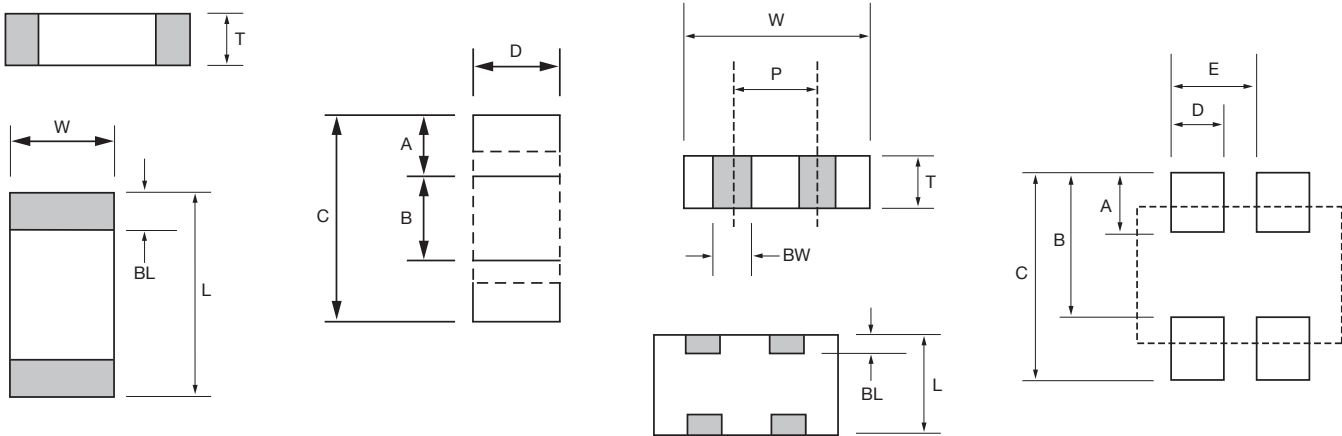

L	W	T	BW	BL	P	A	B	C	D	E
<b>MAV0010</b>										
1.60 ± 0.15 (0.063±0.006)	0.80 ± 0.15 (0.032±0.006)	0.90 Max (0.035) Max	N/A	0.35 ± 0.15 (0.014±0.006)	N/A	0.89 (0.035)	0.76 (0.030)	2.54 (0.100)	0.76 (0.030)	N/A
<b>MAV0020</b>										
1.00 ± 0.15 (0.039±0.006)	1.37 ± 0.15 (0.054±0.006)	0.66 Max (0.026) Max	0.36 ± 0.10 (0.014±0.004)	0.20 ± 0.10 (0.008±0.004)	0.64 REF (0.025)REF	0.46 (0.018)	0.74 (0.029)	1.20 (0.047)	0.30 (0.012)	0.64 (0.025)
<b>MAV0040</b>										
1.00±0.10 (0.040±0.004)	0.50±0.10 (0.020±0.004)	0.60 Max (0.024) Max	N/A	0.25±0.15 (0.010±0.006)	N/A	0.61 (0.024)	0.51 (0.020)	1.70 (0.067)	0.51 (0.020)	N/A

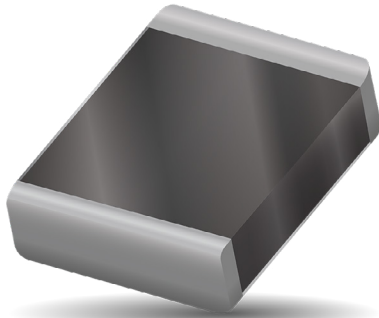

### GENERAL DESCRIPTION

The Glass Encapsulated TransGuard® multilayer varistors are zinc oxide (ZnO) based ceramic semiconductor devices with non-linear, bi-directional V-I characteristics.

They have the advantage of offering bi-directional overvoltage protection as well as EMI/RFI attenuation in a single SMT package.

These large case size parts extend TransGuard range into high energy applications. In addition the glass encapsulation provides enhanced resistance against harsh environment or process such as acidic environment, salts or chlorite flux.

### GENERAL CHARACTERISTICS

- Operating Temperature: -55°C to 125°C
- Case Size: 1206-2200
- Working Voltage: 16-85Vdc
- Energy: 0.7-12J
- Peak Current: 200-2000A

### FEATURES

- Bi-Directional protection
- EMI/RFI attenuation in off-state
- Multi-strike capability
- Sub 1nS response to ESD strike
- High energy / High current
- Glass Encapsulated

### APPLICATIONS

- Professional / Industrial / Commercial Applications
- IC Protection, DC motor protection
- Relays, Controllers, Sensors
- Smart Grids
- Alarms
- Various Applications where Glass Encapsulation is Needed for Harsh Environment / Acid-Resistance
- and more

### HOW TO ORDER

V	G	1812	16	P	400	R	P
Varistor	Glass Encapsulated Chip	Chip Size	Working Voltage	Energy Rating	Clamping Voltage	Package	Termination
		1206	16 = 16Vdc	D = 0.4J	380 = 38V	D = 7" reel	P = Ni/Sn plated
		1210	18 = 18Vdc	F = 0.7J	390 = 40V	R = 7" reel	
		1812	22 = 22Vdc	H = 1.2J	400 = 42V	T = 13" reel	
		2220	26 = 26Vdc	J = 1.5-1.6J	440 = 44V		
		3220	30 = 30Vdc	K = 0.6J	490 = 49V		
			31 = 31Vdc	N = 1.1J	540 = 54V		
			38 = 38Vdc	R = 1.7J	560 = 60V		
			45 = 45Vdc	S = 2.0J	570 = 57V		
			48 = 48Vdc	P = 2.5-3.7J	620 = 67V		
			56 = 56Vdc	U = 4.0-5.0J	650 = 65V		
			60 = 60Vdc	W = 5.1-6.0J	770 = 77V		
			65 = 65Vdc	Y = 6.5-12J	900 = 90V		
			85 = 85Vdc				
			101 = 100Vdc				

### PHYSICAL DIMENSIONS: MM (INCHES)

Size (EIA)	Length (L)	Width (W)	Max Thickness (T)	Land Length (t)
1206	3.20±0.20 (0.126±0.008)	1.60±0.20 (0.063±0.008)	1.70 (0.067)	0.94 max. (0.037 max.)
1210	3.20±0.20 (0.126±0.008)	2.49±0.20 (0.098±0.008)	1.70 (0.067)	0.14 max. (0.045 max.)
1812	4.50±0.30 (0.177±0.012)	3.20±0.30 (0.126±0.012)	2.00 (0.079) 2.50 (0.098) <sup>1)</sup>	1.00 max. (0.040 max.)
2220	5.70±0.40 (0.224±0.016)	5.00±0.40 (0.197±0.016)	2.50 (0.098)	1.00 max. (0.040 max.)
3220	8.20±0.40 (0.323±0.016)	5.00±0.40 (0.197±0.016)	2.50 max. (0.098 max.)	1.30 max. (0.051 max.)

1) Applicable for: VG181285W201, VG1812101W251, VG1812125U271

### ELECTRICAL CHARACTERISTICS

AVX PN	V <sub>w</sub> (DC)	V <sub>w</sub> (AC)	V <sub>B</sub>	V <sub>C</sub>	I <sub>vc</sub>	I <sub>L</sub>	E <sub>T</sub>	I <sub>p</sub>	Cap	Freq
VG120616K390	16	11	24.5±10%	40	1	15	0.6	200	900	K
VG120616N390	16	11	24.5±10%	40	1	15	1.1	300	1300	K
VG181216P390	16	11	24.5±10%	40	5	15	2.9	1000	7000	K
VG181216P400	16	11	24.5±10%	42	5	10	2.9	1000	5000	K
VG222016Y400	16	11	24.5±10%	42	10	10	7.2	1500	13000	K
VG120618D400	18	13	25.5±10%	42	1	15	0.4	150	1200	K
VG120618E380	18	14	22±10%	38	1.0	15	0.5	200	1000	K
VG121018J380	18	14	22±10%	38	2.5	15	1.5	400	2300	K
VG121018J400	18	13	25.5±10%	42	5	10	1.6	500	3100	K
VG181218P380	18	14	22±10%	38	5.0	15	2.3	800	5000	K
VG181218P440	18	14	27.5±10%	44	5	15	2.9	800	5000	K
VG222018W380	18	14	22±10%	38	10	15	5.8	1200	18000	K
VG121022R440	22	17	27±10%	44	2.5	15	1.7	400	1600	K
VG222022Y440	22	17	27±10%	44	10	15	7.2	1200	18000	K
VG222022Y490	22	17	30±10%	49	10	15	6.8	1200	12000	K
VG120626F540	26	18	33.0±10%	54	1	15	0.7	200	600	K
VG121026H560	26	18	34.5±10%	60	5	15	1.2	300	1200	K
VG121026S540	26	20	33±10%	54	2.5	15	1.9	400	1600	K
VG181226P540	26	20	35±10%	54	5	15	3.0	800	3000	K
VG181226P570	26	23	35±10%	57	5	15	2.5	600	3000	K
VG222026Y540	26	20	33±10%	54	10	15	7.8	1200	11000	K
VG222026Y570	26	23	35.0±10%	57	10	15	6.8	1100	7000	K
VG322026N570	26	20	33±10%	57	10	15	1.1	400	5500	K
VG121030H620	30	21	41.0±10%	67	5	15	1.2	280	1850	K
VG181230Y650	30	21	39±10%	65	5	50	6.5	800	3500	K
VG181230Y770	30	21	47.5±10%	77	5	50	6.5	800	3300	K
VG120631M650	31	25	39±10%	65	1.0	15	1.0	200	700	K
VG121031R650	31	25	39±10%	65	2.5	15	1.7	300	1200	K
VG181231P650	31	25	39±10%	65	5	15	3.7	800	2600	K
VG222031Y650	31	25	39.0±10%	65	10	15	9.6	1200	6100	K
VG120638N770	38	30	47±10%	77	1.0	15	1.1	200	500	K
VG121038S770	38	30	47.0±10%	77	2.5	15	2	400	1000	K
VG181238U770	38	30	47.0±10%	77	5	15	4.2	800	1300	K
VG222038Y770	38	30	47.0±10%	77	10	15	12	2000	4200	K
VG322038J920	38	30	47±10%	92	10.0	15	1.5	400	2600	K
VG121045S900	45	35	56±10%	90	2.5	15	2	300	800	K
VG181245U900	45	35	56.0±10%	90	5	15	4.0	500	1200	K
VG222045Y900	45	35	56±10%	90	10	15	12	1000	5000	K
VG121048H101	48	34	62.0±10%	100	5	15	1.2	250	500	K
VG121056P110	56	40	68±10%	110	2.5	15	2.3	250	500	K
VG181256U111	56	40	68.0±10%	110	5	15	4.8	500	800	K
VG222056Y111	56	40	68.0±10%	110	10	15	9	1000	2000	K
VG121060J121	60	42	76.0±10%	120	5	15	1.5	250	400	K
VG120665L131	65	50	82±10%	135	1.0	15	0.8	200	250	K
VG121065P131	65	50	82.0±10%	135	2.5	15	2.7	350	600	K
VG181265U131	65	50	82.0±10%	135	5	15	4.5	400	600	K
VG222065Y131	65	50	82.0±10%	135	10	15	6.5	1100	3000	K
VG181285U161	85	60	100±10%	165	5	15	4.5	400	500	K
VG222085Y161	85	60	100±10%	165	10	15	6.8	800	1500	K

### TELECOM APPLICATIONS

Parts are specified in accordance to CCITT 10x700µs pulse test in addition to standard industrial specifications.

AVX PN	V <sub>w</sub> (DC)	V <sub>w</sub> (AC)	V <sub>B</sub>	V <sub>C</sub>	I <sub>vc</sub>	I <sub>L</sub>	E <sub>T</sub>	I <sub>p</sub>	Cap	Freq	CCITT
VG181285W201	85	60	110±10%	200	45	15	6.0	400	800	K	45
VG1812101W251	100	75	120±10%	250	45	15	6.0	400	500	K	45
VG1812125U271	125	95	150±10%	270	45	15	5	250	250	K	45

V<sub>w</sub>(DC) DC Working Voltage [V]

V<sub>w</sub>(AC) AC Working Voltage [V]

V<sub>B</sub> Typical Breakdown Voltage [V @ 1mADC, 25°C]

V<sub>C</sub> Clamping Voltage [V @ I<sub>vc</sub>]

I<sub>vc</sub> Test Current for VC [A, 8x20µs]

I<sub>L</sub> Maximum leakage current at the working voltage, 25°C [µA]

E<sub>T</sub> Transient Energy Rating [J, 10x1000µs]

I<sub>p</sub> Peak Current Rating [A, 8x20µs]

Cap Typical capacitance [pF] @ frequency specified and 0.5VRMS, 25°C, M = 1MHz, K = 1kHz

CCITT 10 pulses applied at 1min intervals [A, 10x700µs]

# Glass Encapsulated TransGuard® Automotive Series

## Multilayer Varistors for Automotive Applications

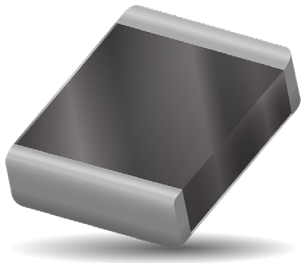

### GENERAL DESCRIPTION

The Glass Encapsulated TransGuard® Automotive Series are zinc oxide (ZnO) based ceramic semiconductor devices with non-linear, bi-directional voltage-current characteristics.

They have the advantage of offering bi-directional overvoltage protection as well as EMI/RFI attenuation in a single SMT package. The Automotive Series high current and high energy handling capability make them well suited for protection against automotive related transients.

These large case size parts extend TransGuard range into high energy applications. In addition the glass encapsulation provides enhanced resistance against harsh environment or process such as acidic environment, salts or chlorite flux.

### GENERAL CHARACTERISTICS

- Operating Temperature: -55°C to 125°C
- Case Size: 1206-2200
- Working Voltage: 16-65Vdc
- Energy: 07-12J
- Peak Current: 200-2000A

### FEATURES

- High Reliability
- High Energy Absorption (Load Dump)
- High Current Handling
- Bi-Directional protection
- EMI/RFI attenuation in off-state
- Multi-strike capability
- Sub 1nS response to ESD strike
- AEC Q200 Qualified

### APPLICATIONS

- Various Automotive Applications
- Internal Combustion Engine (ICE) Vehicles
- Hybrid Electric Vehicles (HEV)
- Plug-in Hybrid Electric Vehicles (PHEV)
- Commercial Vehicles
- Sensors
  - DC Motor
- LIN BUS
  - Relays
- ECU
  - and more
- Applications where Glass Encapsulation is needed for Harsh Environment/Acid-Resistance

### HOW TO ORDER

V	G	AG	1812	16	P	400	R	P
Varistor	Glass Encapsulated Chip	Automotive Series	Chip Size	Working Voltage	Energy Rating	Clamping Voltage	Package	Termination
			1206	16 = 16Vdc	D = 0.4J	390 = 40V	D = 7" reel	P = Ni/Sn plated
			1210	18 = 18Vdc	F = 0.7J	400 = 42V	R = 7" reel	
			1812	22 = 22Vdc	H = 1.2J	440 = 44V	T = 13" reel	
			2220	26 = 26Vdc	J = 1.6J	490 = 49V		
			3220	30 = 30Vdc	K = 0.6J	540 = 54V		
				31 = 31Vdc	N = 1.1J	560 = 60V		
				34 = 34Vdc	S = 2.0J	650 = 65V		
				42 = 42Vdc	P = 2.5-3.7J	770 = 77V		
				48 = 48Vdc	U = 4.0-5.0J	900 = 90V		
				60 = 60Vdc	Y = 6.5-12J	101 = 100V		
				65 = 65Vdc		121 = 120V		
						131 = 135V		

### PHYSICAL DIMENSIONS:

mm (inches)

Size (EIA)	Length (L)	Width (W)	Max Thickness (T)	Land Length (t)
1206	3.20±0.20 (0.126±0.008)	1.60±0.20 (0.063±0.008)	1.70 (0.067)	0.94 max. (0.037 max.)
1210	3.20±0.20 (0.126±0.008)	2.49±0.20 (0.098±0.008)	1.70 (0.067)	0.14 max. (0.045 max.)
1812	4.50±0.30 (0.177±0.012)	3.20±0.30 (0.126±0.012)	2.00 (0.079)	1.00 max. (0.040 max.)
2220	5.70±0.40 (0.224±0.016)	5.00±0.40 (0.197±0.016)	2.50 (0.098)	1.00 max. (0.040 max.)
3220	8.20±0.40 (0.323±0.016)	5.00±0.40 (0.197±0.016)	2.50 max. (0.098 max.)	1.30 max. (0.051 max.)



# Glass Encapsulated TransGuard® Automotive Series

## Multilayer Varistors for Automotive Applications



### ELECTRICAL CHARACTERISTICS

AVX PN	V <sub>w</sub> (DC)	V <sub>w</sub> (AC)	V <sub>B</sub>	V <sub>C</sub>	I <sub>VC</sub>	I <sub>L</sub>	E <sub>T</sub>	E <sub>LD</sub>	I <sub>P</sub>	Cap	Freq	V <sub>Jump</sub>	P <sub>Diss, MAX</sub>
VGAS120616K390	16	11	24.5±10%	40	1	15	0.6	1.5	200	900	K	27.5	0.01
VGAS120616N390	16	11	24.5±10%	40	1	15	1.1	2	200	1300	K	27.5	0.01
VGAS121016S390	16	14	24.5±10%	40	2.5	15	2.0	5.00	500	3000	K	27.5	0.01
VGAS121016J400	16	13	25.5±10%	42	5	10	1.6	3	500	3100	K	27.5	0.03
VGAS181216P390	16	11	24.5±10%	40	5	15	2.9	10	1000	7000	K	27.5	0.07
VGAS181216P400	16	11	24.5±10%	42	5	10	2.9	10	1000	5000	K	27.5	0.07
VGAS222016Y390	16	11	24.5±10%	40	10	15	10.2	45	1500	20000	K	27.5	0.08
VGAS222016Y400	16	11	24.5±10%	42	10	10	7.2	25	1500	13000	K	27.5	0.10
VGAS120618D400	18	13	25.5±10%	42	1	15	0.4	1.5	150	1200	K	27.5	0.008
VGAS121018J400	18	13	25.5±10%	42	5	15	1.6	3.0	500	2300	K	27.5	0.03
VGAS181218P440	18	14	27.5±10%	44	5	15	2.9	6	800	5000	K	27.5	0.05
VGAS222022Y490	22	17	30.0±10%	49	10	15	6.8	25	1200	12000	K	27.5	0.03
VGAS120626F540	26	18	33.0±10%	54	1	15	0.7	1.5	200	600	K	27.5	0.008
VGAS121026H560	26	18	34.5±10%	60	5	15	1.2	3	300	1200	K	27.5	0.018
VGAS181226P570	26	23	35.0±10%	57	5	15	2.5	8	600	3000	K	30	0.015
VGAS222026Y570	26	23	35.0±10%	57	10	15	6.8	25	1100	7000	K	30	0.03
VGAS322026Z570	26	23	35.0±10%	57	10	15	13.0	50	1800	15000	K	30	0.04
VGAS121030H620	30	21	41.0±10%	67	5	15	1.2	3	280	1850	K	30	0.018
VGAS120631M650	31	25	39.0±10%	65	1	15	1	2.5	200	700	K	30	0.03
VGAS121031R650	31	25	39.0±10%	65	2.5	15	1.7	4.5	300	1200	K	30	0.05
VGAS181231P650	31	25	39.0±10%	65	5	15	3.7	8	800	2600	K	30	0.06
VGAS222031Y650	31	25	39.0±10%	65	10	15	9.6	23	1200	6100	K	30	0.03
VGAS120634N770	34	30	47.0±10%	77	1.0	15	1.1	1.50	200	500	K	47	0.02
VGAS121034S770	34	30	47.0±10%	77	2.5	15	2	3	400	1000	K	48	0.04
VGAS181234U770	34	30	47.0±10%	77	5	15	5	6.1	800	1500	K	48	0.08
VGAS222034Y770	34	30	47.0±10%	77	10	15	12	25	2000	6300	K	48	0.24
VGAS181242U900	42	35	56.0±10%	90	5	15	4.0	6	500	1200	K	48	0.015
VGAS222042Y900	42	37	56.0±10%	90	10	15	12	24	1000	5000	K	48	0.06
VGAS121048H101	48	34	62.0±10%	100	5	15	1.2	-	250	500	K	48	0.022
VGAS181256U111	56	40	68.0±10%	110	5.0	15	4.8	-	500	1100	K	48	0.04
VGAS121060J121	60	42	76.0±10%	120	5	15	1.5	-	250	400	K	48	0.03
VGAS121065P131	65	50	82.0±10%	135	2.5	15	2.7	-	350	600	K	48	0.05
VGAS181265U131	65	50	82.0±10%	135	5.0	15	4.5	-	400	800	K	48	0.03
VGAS222065Y131	65	50	82.0±10%	135	10	15	6.5	-	1100	3000	K	48	0.06
VGAS181285U161	85	60	100±10%	165	5.0	15	4.5	-	400	500	K	48	0.04

V<sub>w</sub>(DC) DC Working Voltage [V]

V<sub>w</sub>(AC) AC Working Voltage [V]

V<sub>B</sub> Typical Breakdown Voltage [V @ 1mADC, 25°C]

V<sub>C</sub> Clamping Voltage [V @ I<sub>VC</sub>]

I<sub>VC</sub> Test Current for VC [A, 8x20μs]

I<sub>L</sub> Maximum leakage current at the working voltage, 25°C [μA]

E<sub>T</sub> Transient Energy Rating [J, 10x1000μs]

E<sub>LD</sub> Load Dump Energy (x10) [J]

I<sub>P</sub> Peak Current Rating [A, 8x20μs]

Cap Typical capacitance [pF] @ frequency specified and 0.5V<sub>RMS</sub>, 25°C, M = 1MHz, K = 1kHz

V<sub>Jump</sub> Jump Start [V, 5 min]

P<sub>DISS</sub> Power Dissipation [W]

### AUTOMOTIVE SERIES – LOAD DUMP TEST ACCORDING TO ISO DP7637 REV 2 PULSE 5

Automotive Load Dump Pulse  
(According to ISO 7637 Pulse 5)

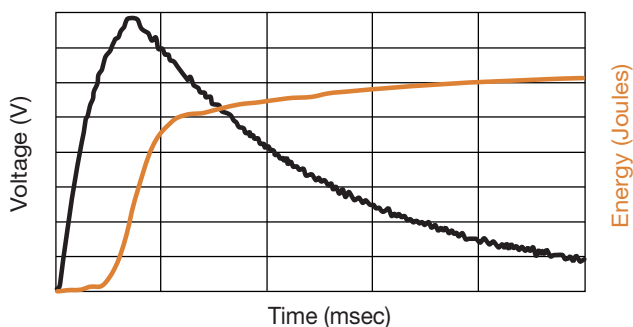

When using the test method indicated below, the amount of Energy dissipated by the varistor must not exceed the Load Dump Energy value specified in the product table.

#### 12V SYSTEMS

VGAS181216P400	0.5Ω	1Ω	4Ω
100ms	46	52	72
200ms	37	41	59
400ms	32	35	51
VGAS222016Y400	0.5Ω	1Ω	4Ω
100ms	53	60	77
200ms	50	55	73
400ms	47	50	66

# High Temp. Automotive VT Series

+150°C and 175°C Rated Varistors

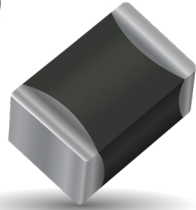

## GENERAL DESCRIPTION

AVX High Temperature 150/175°C Multi-Layer Varistors are designed for underhood and other high temperature automotive or industrial applications. Parts are AEC-Q200 qualified.

They offer bi-directional overvoltage protection as well as EMI/RFI attenuation in a single SMT package. This allows designers the ability to combine the circuit protection and EMI/ RFI attenuation function into a single highly reliable device.

Products have been tested, qualified, and specified to 150/175°C and they do not require any derating over specified operating temperature range.

## GENERAL DESCRIPTION

- Operating Temp.:
- VTA3: -55 to +150°C
- VTA7: -55 to +175°C
- Working Voltage: 14 - 31Vdc
- Case Size: 0603 - 1210

## FEATURES

- +150/175°C rated, with no derating
- High Reliability
- AEC Q200 Qualified
- Bi-Directional protection
- EMI/RFI attenuation
- ESD rated to 25kV (HBM ESD Level 6)

## APPLICATIONS

- Under hood
- Down Hole Drilling
- High temperature Automotive and Industrial Applications

## HOW TO ORDER

**VT**  
Varistor Temp Rated

**A7**  
Automotive  
175°C  
A3 = 150°C  
A7 = 175°C

**0603**  
Case Size  
0603  
0805  
1206  
1210

**18**  
Working Voltage  
12=12Vdc  
14=14Vdc  
18=18Vdc  
26=26Vdc  
31=31Vdc  
38=38Vdc  
48=48Vdc

**A**  
Energy Rating  
A=0.1J  
C=0.3J  
E=0.5J  
J=1.6J

**400**  
Clamping Voltage  
300=32V  
350=35V  
400=42V  
650=65V  
670=67V

**R**  
Package  
D = 7" (1,000)  
R = 7" (4,000)  
T = 13" (10,000)

**P**  
Termination  
P = Ni/Sn plated



MSL 1  
Pb Free 260°C

## DIMENSIONS

mm(inches)

Size (EIA)	Length (L)	Width (W)	Max Thickness (T)	Land Length (t)
0603	1.60±0.15 (0.063±0.006)	0.80±0.15 (0.031±0.006)	0.90 (0.035)	0.35±0.15 (0.014±0.006)
0805	2.01±0.20 (0.079±0.008)	1.25±0.20 (0.049±0.008)	1.02 (0.040)	0.71 max. (0.028 max.)
1206	3.20±0.20 (0.126±0.008)	1.60±0.20 (0.063±0.008)	1.02 (0.040)	0.94 max. (0.037 max.)
1210	3.20±0.20 (0.126±0.008)	2.49±0.20 (0.098±0.008)	1.70 (0.067)	1.14 max. (0.045 max.)

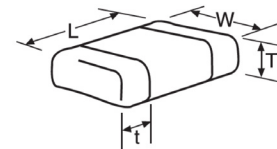

# High Temp. Automotive VT Series

+150°C and 175°C Rated Varistors



## ELECTRICAL CHARACTERISTICS VTA3 (150°C)

AVX PN	V <sub>w</sub> (DC)	V <sub>w</sub> (AC)	V <sub>B</sub>	V <sub>C</sub>	I <sub>VC</sub>	I <sub>L</sub>	E <sub>T</sub>	E <sub>LD</sub>	I <sub>P</sub>	Cap	Freq	V <sub>Jump</sub>	P <sub>Diss. Max</sub>
	Vdc	Vac	V	V	A	μA	J	J	A	pF		V	W
VTA3040205X150	5.6	4.0	8.5±20%	18	1	10	0.05	-	20	200	K	-	0.001
VTA3080512D250	12	8.5	16±15%	27	1	10	0.4	-	200	900	K	-	0.008
VTA3080514C300	14	10	18.5±12%	32	1	10	0.3	0.7	120	900	K	20	0.006
VTA3120614E300	14	10	18.5±12%	32	1	10	0.5	1.3	200	1400	K	20	0.01
VTA3121014J300	14	10	18.5±12%	32	2.5	10	1.6	3	500	5000	K	20	0.03
VTA30402018X400	18	13	25.5±10%	42	1	10	0.05	-	20	60	K	27.5	0.001
VTA3121031R650	31	25	39±10%	65	2.5	10	1.7	4.5	300	1500	K	20	0.03
VTA3080538E770	38	30	47±10%	77	1	10	0.5	1	120	275	K	48	0.01
VTA3120642R800	42	32	51±10%	80	1	10	1.7	2.0	250	750	K	48	0.003

## ELECTRICAL CHARACTERISTICS VTA7 (175°C)

AVX PN	V <sub>w</sub> (DC)	V <sub>w</sub> (AC)	V <sub>B</sub>	V <sub>C</sub>	I <sub>VC</sub>	I <sub>L</sub>	E <sub>T</sub>	E <sub>LD</sub>	I <sub>P</sub>	Cap	Freq	V <sub>Jump</sub>	P <sub>Diss. Max</sub>
	Vdc	Vac	V	V	A	μA	J	J	A	pF		V	W
VTA7060314A300	14	10	18.5±12%	32	1	10	0.1	-	50	400	K	20	0.003
VTA7060314E350	14	10	20.5±10%	35	1	10	0.5	-	120	900	K	20	0.01
VTA7060318A400	18	13	23±10%	42	1	10	0.1	0.25	30	275	K	27.5	0.003
VTA7080518C400	18	13	25.5±10%	42	1	10	0.3	1	120	450	K	27.5	0.006
VTA7080526D580	26	18	34.5±10%	60	1	10	0.4	0.6	100	275	K	29	0.008
VTA7060331A670	31	25	39±10%	67	1	10	0.1	0.25	30	90	M	29	0.003
VTA7080531C650	31	25	39±10%	65	1	10	0.3	1	80	275	K	29	0.006
VTA7120648M10	48	34	62±10%	100	1	10	1.0	1.5	200	300	K	48	0.002

V<sub>w</sub>(DC) DC Working Voltage [V]

V<sub>w</sub>(AC) AC Working Voltage [V]

V<sub>B</sub> Typical Breakdown Voltage [V @ 1mA<sub>DC</sub>]

V<sub>C</sub> Clamping Voltage [V @ I<sub>VC</sub>]

I<sub>VC</sub> Test Current for V<sub>C</sub>

I<sub>L</sub> Maximum leakage current at the working voltage, 25°C [μA]

E<sub>T</sub> Transient Energy Rating [J, 10x1000μS]

E<sub>LD</sub> Load Dump Energy (x10)

I<sub>P</sub> Peak Current Rating [A, 8x20μS]

Cap Typical capacitance [pF] @ frequency specified and 0.5V<sub>RMS</sub>, 25°C

V<sub>Jump</sub> Jump Start (V)

P<sub>Diss. Max</sub> Power Dissipation (W)

## ESD RATING

AVX PN	IEC 61000-4-2	ISO 10605		AEC-Q200 (Lvl.6)
	150 pF / 330 Ω Contact Discharge	330 pF / 330 Ω Contact Discharge	330 pF / 2000 Ω Contact Discharge	150 pF / 2000 Ω Air Discharge
<b>VTA3 (150°C)</b>				
VTA3080514C300	30kV	30kV	30kV	25kV
VTA3120614E300	30kV	30kV	30kV	25kV
VTA3121014J300	30kV	30kV	30kV	25kV
VTA3121031R650	30kV	30kV	30kV	25kV
<b>VTA7 (175°C)</b>				
VTA7060318A400	25 kV	30 kV	30 kV	25 kV
VTA7080518C400	30 kV	30 kV	30 kV	25 kV
VTA7060331A670	30 kV	30 kV	30 kV	25 kV
VTA7080531C650	30 kV	30 kV	30 kV	25 kV

# High Temp. Automotive VT Series

+150°C and 175°C Rated Varistors



## VTA3 (+150°C): POWER DERATING CURVE (CURRENT, ENERGY, POWER)

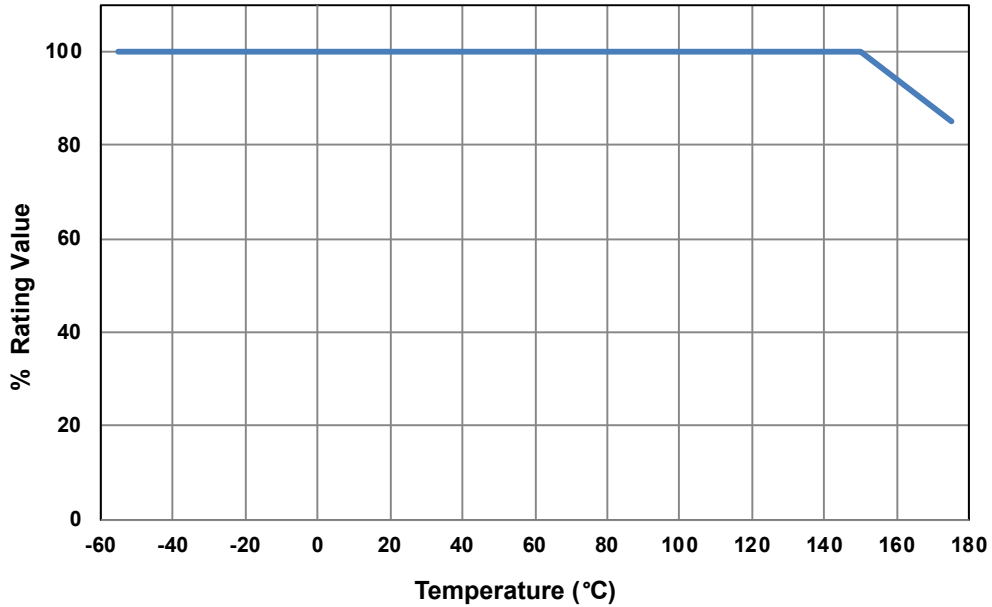

## VTA3 (+150°C): V-I CHARACTERISTICS

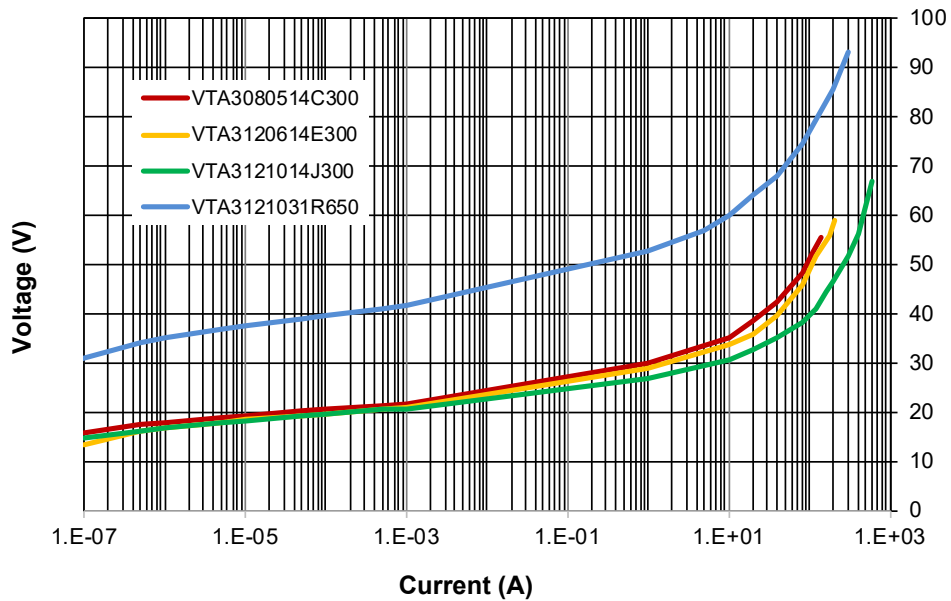

# High Temp. Automotive VT Series

+150°C and 175°C Rated Varistors



## VTA3 (+150°C): FORWARD TRANSMISSION CHARACTERISTICS (S21)

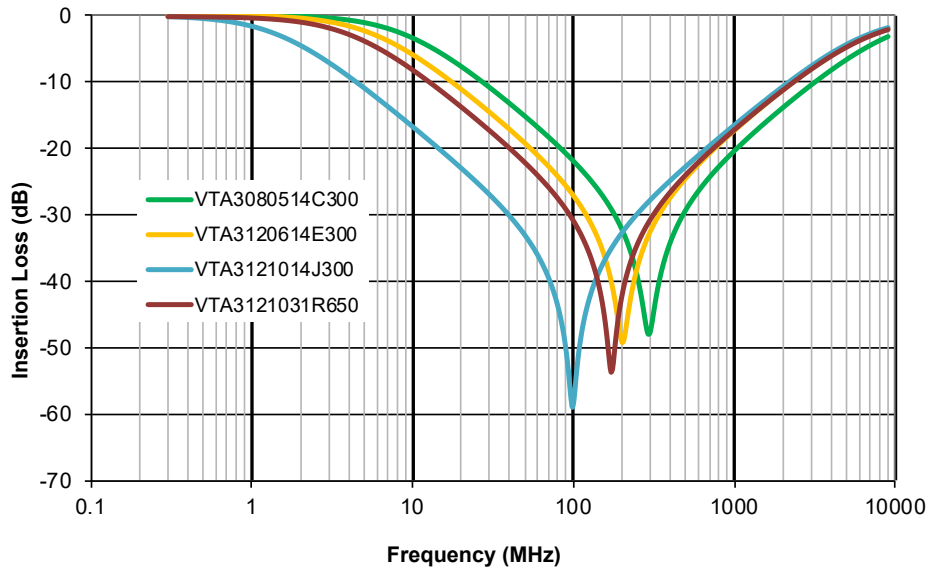

# High Temp. Automotive VT Series

+150°C and 175°C Rated Varistors



## VTA7 (+175°C): POWER DERATING CURVE (CURRENT, ENERGY, POWER)

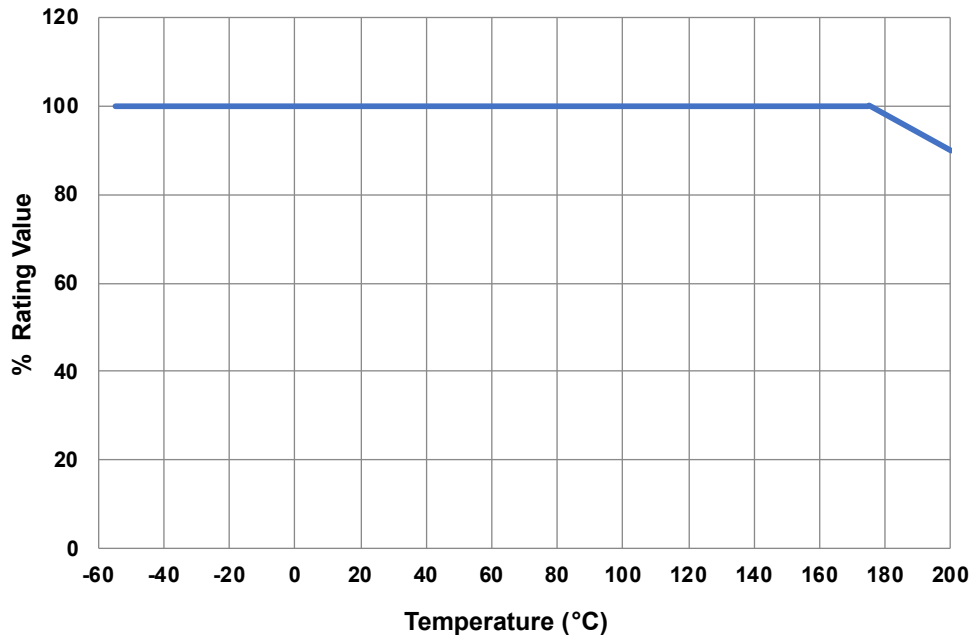

## VTA7 (+175°C): CAPACITANCE VS TEMPERATURE

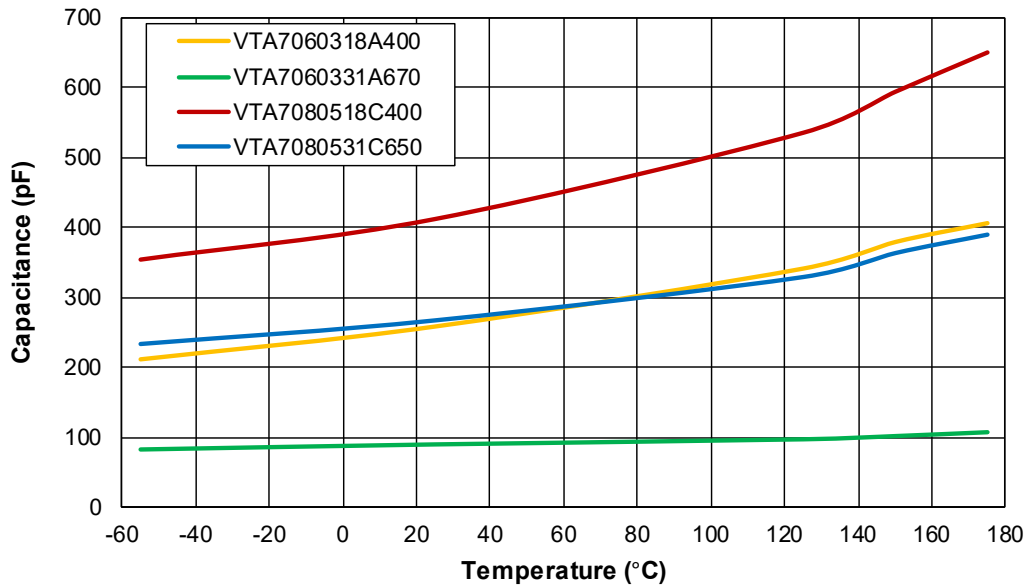

# High Temp. Automotive VT Series

+150°C and 175°C Rated Varistors



## VTA7 (+175°C): V-I CHARACTERISTICS

VTA7060318A400

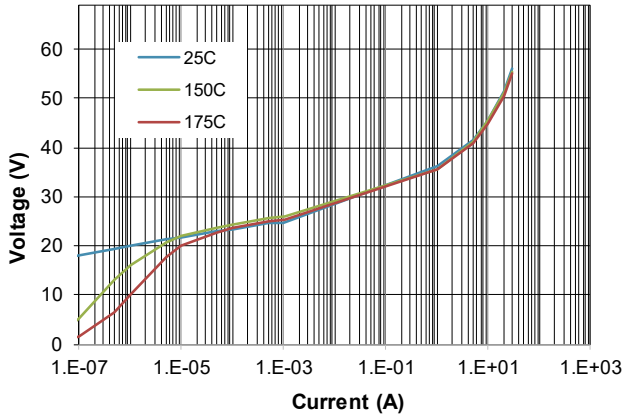

VTA7060331A650

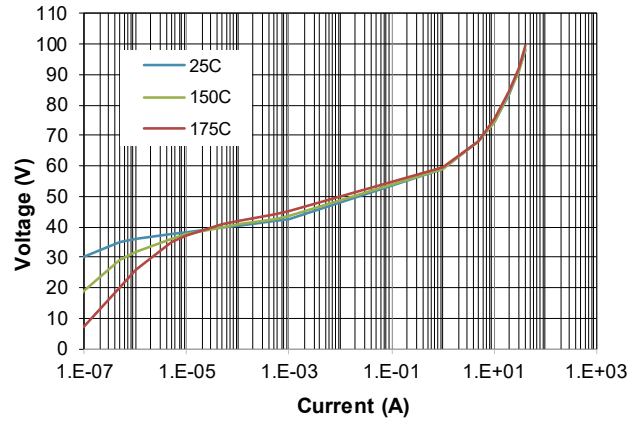

VTA7080518C400

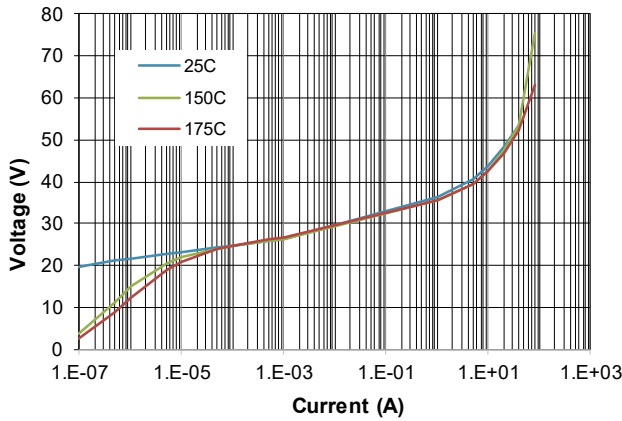

VTA7080531C650

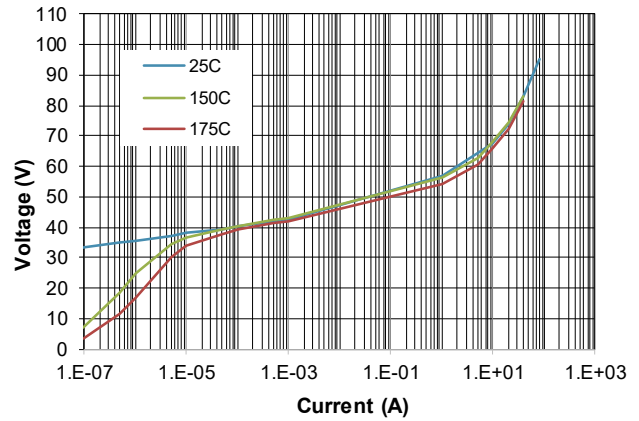

VTA7060314A300

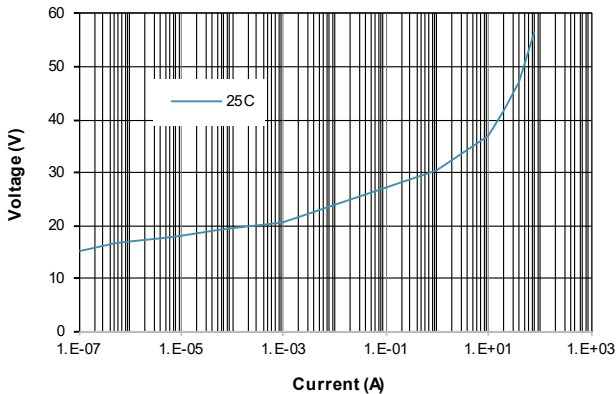

# High Temp. Automotive VT Series

+150°C and 175°C Rated Varistors



## VTA7 (+175°C): FORWARD TRANSMISSION CHARACTERISTICS (S21)

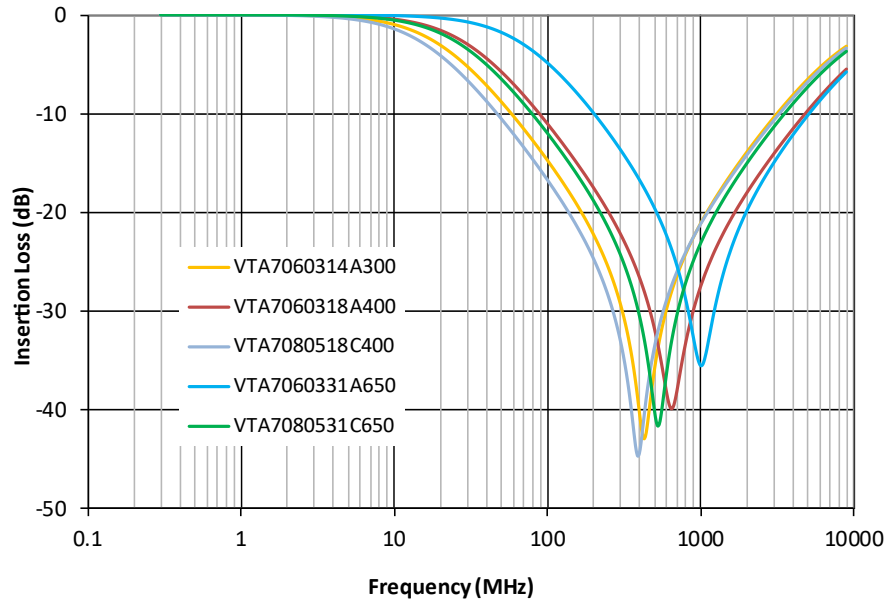



# High Temp. Automotive CAN Series

## 150°C Rated Varistors

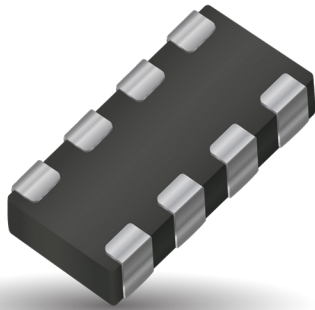

### GENERAL DESCRIPTION

AVX High Temperature Multi-Layer Varistors are designed for underhood applications. Products have been tested, qualified, and specified to 150°C. The MLV advantage is EMI/RFI attenuation in the off state. This allows designers the ability to combine the circuit protection and EMI/RFI attenuation function into a single highly reliable device.

### FEATURES

- Operating Temperature: -55°C to +150°C
- AEC Q200 qualified
- ESD rating to 25kV contact
- EMI/RFI attenuation in off state
- Excellent current and energy handling

### APPLICATIONS

- Under hood
- Down Hole Drilling
- High temperature applications
- Communication Bus
- Sensors
- RF Circuits
- Capacitance sensitive applications and more

## CAN HIGH TEMPERATURE SERIES

### HOW TO ORDER

<b>CAN</b>	<b>AT</b>	<b>01</b>	<b>W</b>	<b>P</b>	
Type	Series	Case Size	Packaging	Termination	
Controlled Area Network Varistor	Automotive High Temperature	01 = 0603 02 = 0405 2-Element 04 = 0612 4-Element	D = 7" (1000 pcs) R = 7" (4,000 pcs) T = 13" (10,000pcs)	P = Ni Barrier/ 100% Sn (matte)	

AVX Part Number	V <sub>w</sub> (DC)	V <sub>w</sub> (AC)	V <sub>B</sub>	I <sub>L</sub>	E <sub>T</sub>	I <sub>P</sub>	Cap	Case Size	Elements
CANAT01--	≤ 18	≤ 14	120	10	0.015	4	22	0603	1
CANAT02--	≤ 18	≤ 14	70	10	0.015	4	22	0405	2
CANAT04--	≤ 18	≤ 14	100	10	0.015	4	22	0612	4

V <sub>w</sub> (DC)	DC Working Voltage [V]	I <sub>L</sub>	Maximum leakage current at the working voltage [μA]
V <sub>w</sub> (AC)	AC Working Voltage [V]	E <sub>T</sub>	Transient Energy Rating [J, 10x1000μS]
V <sub>B</sub>	Breakdown Voltage [V @ 1mADC]	I <sub>P</sub>	Peak Current Rating [A, 8x20μS]
V <sub>C</sub>	Clamping Voltage [V @ IVC]	Cap	Capacitance [pF] @ 1KHz specified and 0.5V <sub>RMS</sub>

## ANTENNAGUARD HIGH TEMPERATURE SERIES

### HOW TO ORDER

<b>VCAT</b>	<b>06</b>	<b>AG</b>	<b>18</b>	<b>120</b>	<b>Y</b>	<b>A</b>	<b>T</b>	<b>1</b>	<b>A</b>
Type	Case Size	Varistor Series	Working Voltage	Cap	Non-Std. Cap Tolerance	N/A	Termination Finish	Reel Size	Reel Quantity
High Temperature Varistor	04 = 0402 06 = 0603	AntennaGuard	18 = 18Vdc				P = Ni Barrier/ 100% Sn	1 = 7" 3 = 13"	A = 4000 or 10,000

AVX Part Number	V <sub>w</sub> (DC)	V <sub>w</sub> (AC)	I <sub>L</sub>	Cap	Cap Tolerance	Case Size
VCAT06AG18120YAT--	≤ 18	≤ 14	10	12	+4, -2pF	0603

V <sub>w</sub> (DC)	DC Working Voltage [V]	I <sub>L</sub>	Maximum leakage current at the working voltage [μA]
V <sub>w</sub> (AC)	AC Working Voltage [V]	Cap	Capacitance [pF] @ 1KHz specified and 0.5V <sub>RMS</sub>

# High Temp. Automotive CAN Series

## 150°C Rated Varistors

### PHYSICAL DIMENSIONS

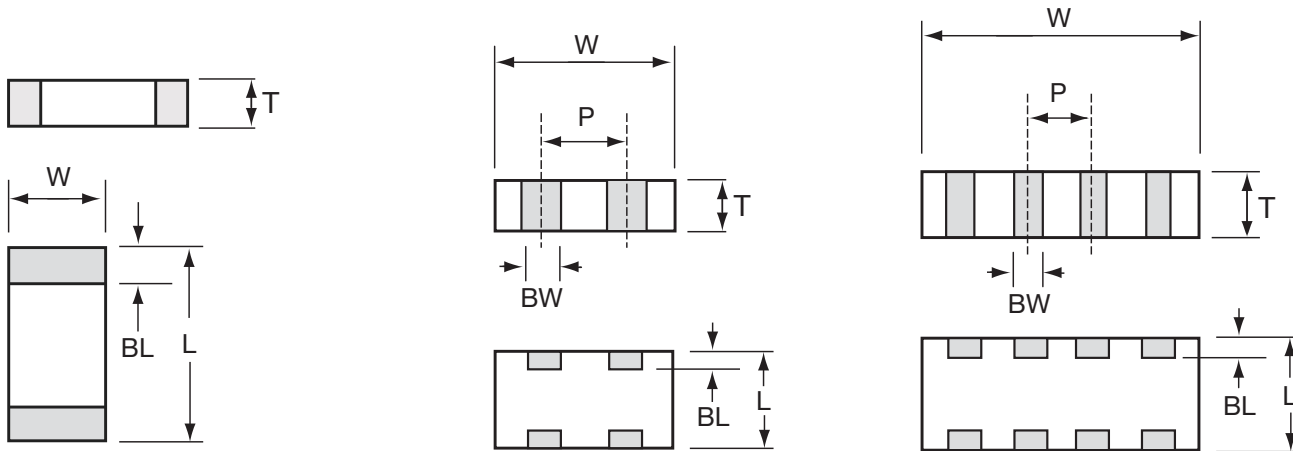

### 0603 DISCRETE DIMENSIONS

mm (inches)

L	W	T	BW	BL	P
1.60±0.15 (0.063±0.006)	0.80±0.15 (0.032±0.006)	0.90 MAX (0.035 MAX)	N/A	0.35±0.15 (0.014±0.006)	N/A

### 0405 2 ELEMENTS ARRAY DIMENSIONS

mm (inches)

L	W	T	BW	BL	P
1.00±0.15 (0.039±0.006)	1.37±0.15 (0.054±0.006)	0.66 MAX (0.026 MAX)	0.36±0.10 (0.014±0.004)	0.20±0.10 (0.008±0.004)	0.64 REF (0.025 REF)

### 0612 4 ELEMENTS ARRAY DIMENSIONS

mm (inches)

L	W	T	BW	BL	P
1.60±0.20 (0.063±0.008)	3.20±0.20 (0.126±0.008)	1.22 MAX (0.048 MAX)	0.41±0.10 (0.016±0.004)	0.18 <sup>+0.25</sup> <sub>-0.08</sub> (0.008) <sup>+0.10</sup> <sub>-0.03</sub>	0.76 REF (0.030 REF)

# High Temp. Low Leakage Automotive Varistors

## 150°C Rated Low Leakage Automotive Varistors

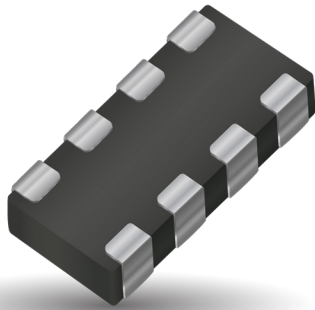

### GENERAL DESCRIPTION

AVX High Temperature Low Leakage Multi-Layer Varistors are designed for underhood and high temperature applications where low leakage component is required. Parts are tested, qualified and specified to 150°C. The MLV advantage is EMI/RFI attenuation in the off state. This allows designers the ability to combine the circuit protection and EMI/RFI attenuation function into a single highly reliable device.

### GENERAL CHARACTERISTICS

- Operating Temperature: -55°C to +150°C

### FEATURES

- Rated at 150°C
- AEC Q200 qualified
- ESD rating to 25kV (HBM ESD Level 6)
- EMI/RFI attenuation in off state
- Very Low Leakage

### APPLICATIONS

- Under hood
- High temperature applications
- Bus Interface Protection
- CAN Bus
- BCM, TCU
- Capacitance sensitive applications and more

## COMMUNICATION BUS - HIGH TEMPERATURE LOW LEAKAGE VARISTOR

### HOW TO ORDER

**CAN**  
Type  
Controlled Area Network Varistor

**ATL**  
Series  
Automotive High Temperature Low Leakage

**07**  
Case Size  
07 = 0603

**R**  
Packaging  
D = 7" (1000 pcs)  
R = 7" (4,000 pcs)  
T = 13" (10,000 pcs)

**P**  
Termination  
P = Ni Barrier/100% Sn



PN	VW (DC)	VW (AC)	VB	VC	IVC	IL	ET	IP	Typ Cap	Cap Tol	Freq	VJump	PDiss max
CANATL07	32	25	61±15%	120	1	<1	0.05	5	10	±50%	M	27.5	0.003

$V_w(\text{DC})$	DC Working Voltage [V]	$E_T$	Transient Energy Rating [J, 10x1000µS]
$V_w(\text{AC})$	AC Working Voltage [V]	$I_p$	Peak Current Rating [A, 8x20µS]
$V_B$	Breakdown Voltage [V @ 1mADC, 25°C]	Cap	Capacitance [pF] @ 1KHz specified and 0.5V <sub>RMS</sub>
$V_C$	Clamping Voltage [V @ IVC]	$V_{\text{Jump}}$	Jump Start [V, 5 min]
$I_{VC}$	Test Current for VC [A, 8x20µs]	$P_{\text{DISS}}$	Max Power Dissipation [W]
$I_L$	Maximum leakage current at the working voltage, 25°C [µA]		

# High Temp. Low Leakage Automotive Varistors

## 150°C Rated Low Leakage Automotive Varistors

### S21 CHARACTERISTICS

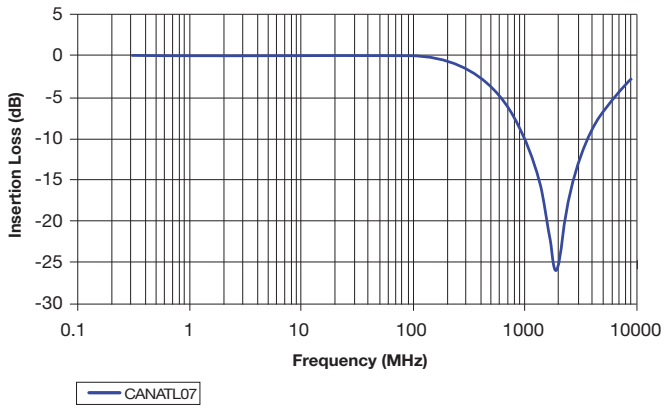

### PHYSICAL DIMENSIONS AND RECOMMENDED PAD LAYOUT

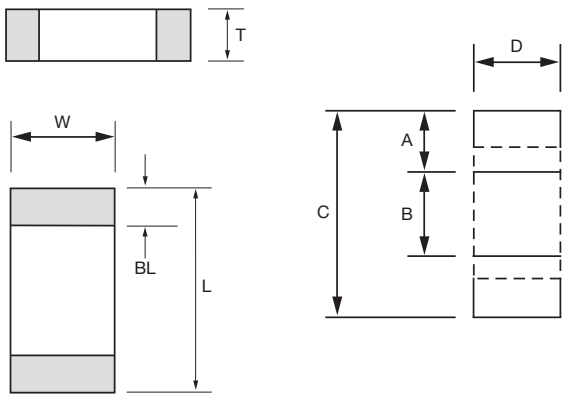

#### 0603 DISCRETE DIMENSIONS

mm (inches)

L	W	T	BL
1.60±0.15 (0.063±0.006)	0.80±0.15 (0.032±0.006)	0.90 MAX (0.035 MAX)	0.35±0.15 (0.014±0.006)

#### 0603 SOLDERING PAD

mm (inches)

A	B	C	D
0.89 (0.035)	0.76 (0.030)	2.54 (0.100)	0.76 (0.030)

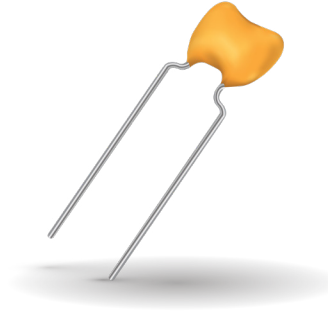

### GENERAL DESCRIPTION

AVX Radial Leaded Multi-Layer Varistors are AEC-Q200 Qualified and are designed for durability in harsh environments or applications where leaded component is preferred. The MLV advantage is bi-directional transient voltage protection and EMI/RFI attenuation in the off state. This allows designers to combine the circuit protection and EMI/RFI attenuation function into a single highly reliable device.

### GENERAL CHARACTERISTICS FEATURES

- Operating Temperatures: -55°C to +125°C
- Working Voltage: 18-48Vdc
- AEC Q200 qualified
- ESD rated to 25kV (HBM ESD Level 6)
- EMI/RFI attenuation in off state
- Excellent current and energy handling

### APPLICATIONS

- Harsh environment
- Inductive switching
- DC Motors
- Water pump
- Fuel pump
- Relays and more

### HOW TO ORDER

<b>VR20</b> ┆ AVX Style VR20	<b>AS</b> ┆ Series AS = Automotive	<b>18</b> ┆ Voltage 18 = 18V 26 = 26V 48 = 48V	<b>F</b> ┆ Energy F = 0.7J H = 1.2J J = 1.6J	<b>390</b> ┆ Clamping Voltage 390 = 42V 540 = 54V 560 = 60V 101 = 100V	<b>R</b> ┆ Leads R = RoHS Compliant	<b>TR2</b> ┆ Packaging Blank = Bulk TR1 = T&R Standard 1 TR2 = T&R Standard 2
---------------------------------------	---	---	---	--	---	--



### ELECTRICAL CHARACTERISTICS

AVX Part Number	V <sub>w</sub> DC	V <sub>w</sub> AC	V <sub>B</sub>	V <sub>c</sub>	I <sub>vc</sub>	I <sub>L</sub>	E <sub>T</sub>	E <sub>LD</sub>	I <sub>p</sub>	Cap	Freq	V <sub>JUMP</sub>	P <sub>DISS</sub>
VR20AS18J390	18.0	13.0	25.5±10%	42	5	10	1.6	3	500	3100	K	27.5	0.030
VR20AS26F540	26.0	18.0	33.0±10%	54	1	15	0.7	1.5	200	600	K	27.5	0.008
VR20AS26H560	26.0	18.0	34.5±10%	60	5	10	1.2	3	300	1200	K	27.5	0.018
VR20AS48H101	48.0	34.0	62.0±10%	100	1	10	1.2	-	250	500	K	48	0.022

V <sub>w</sub> (DC)	DC Working Voltage [V]	E <sub>T</sub>	Transient Energy Rating [J, 10x1000µS]
V <sub>w</sub> (AC)	AC Working Voltage [V]	E <sub>LD</sub>	Load Dump Energy (x10) [J]
V <sub>B</sub>	Typical Breakdown Voltage [V @ 1mA <sub>DC</sub> ]	I <sub>p</sub>	Peak Current Rating [A, 8x20µS]
V <sub>c</sub>	Clamping Voltage [V @ I <sub>vc</sub> ]	Cap	Typical capacitance [pF] @ frequency specified and 0.5V <sub>RMS</sub>
I <sub>vc</sub>	Test Current for V <sub>c</sub>	V <sub>JUMP</sub>	Jump Start (V)
I <sub>L</sub>	Maximum leakage current at the working voltage [µA]	P <sub>DISS</sub>	Power Dissipation (W)

### PHYSICAL DIMENSIONS

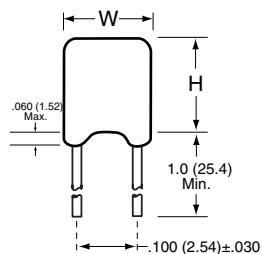

mm (inches)					
AVX Style	Width (W)	Height (H)	Thickness (T)	Lead Spacing	Lead Diameter
VR20	5.59 Max (0.220)	5.08 Max (0.200)	3.175 Max (0.125)	2.54 (0.100)	0.508 (0.020)

### TYPICAL PERFORMANCE CURVES

Typical Voltage Current Characteristics

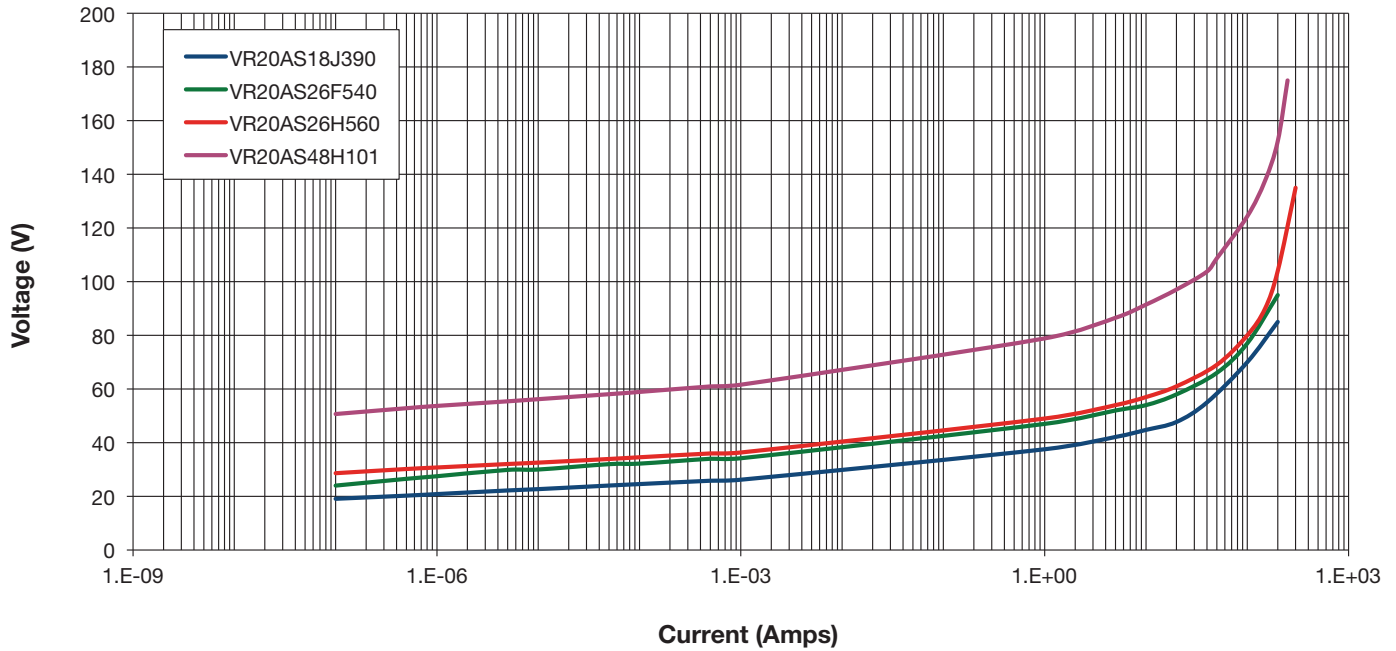

### TAPE & REEL PACKAGING OPTIONS

TR1

Tape & Reel Standard 1

TR2

Tape & Reel Standard 2

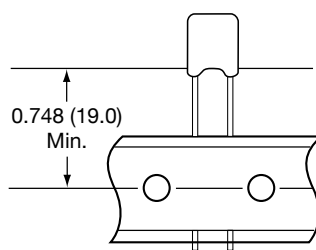
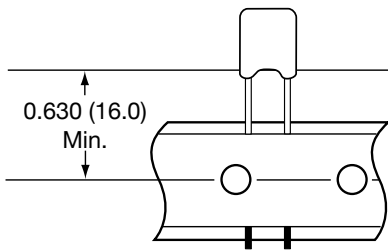

# Radial Leaded High Temp. Automotive TransGuard®

## 150°C Rated Radial Leaded Varistors



### GENERAL DESCRIPTION

AVX High Temperature Multi-Layer Varistors are designed for underhood applications. Products have been tested, qualified, and specified to 150°C. The Radial Leaded TransGuard is built for durability in harsh environments. The MLV advantage is EMI/RFI attenuation in the off state. This allows designers to combine the circuit protection and EMI/RFI attenuation function into a single highly reliable device.

### GENERAL CHARACTERISTICS

- Operating Temperatures:  
-55°C to +150°C
- Working Voltage:  
14-48Vdc

### FEATURES

- Rated at 150°C
- AEC Q200 qualified
- ESD rated to 25kV (HBM ESD Level 6)
- EMI/RFI attenuation in off state
- Excellent current and energy handling

### APPLICATIONS

- Under hood
- Down Hole Drilling
- DC Motors
- Relays
- Inductive Loads
- High Temperature/ Harsh environment and more

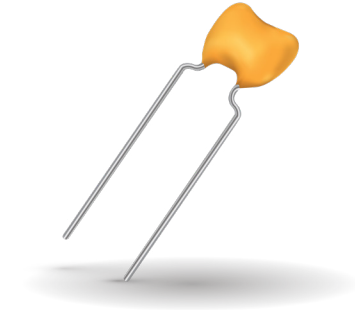

### HOW TO ORDER

<b>VR15</b>	<b>AT</b>	<b>18</b>	<b>A</b>	<b>650</b>	<b>R</b>	<b>TR2</b>
<b>AVX Style</b>	<b>Series</b>	<b>Voltage</b>	<b>Energy</b>	<b>Clamping Voltage</b>	<b>Leads</b>	<b>Packaging</b>
VR15 VR20	AT = 150°C Automotive	14 = 14V 18 = 18V 26 = 26V 48 = 48V	A = 0.1J D = 0.4J S = 2.0J	580 = 60V 650 = 67V 101 = 100V 151 = 150V	R = RoHS Compliant	Blank = Bulk TR1 = T&R Standard 1 TR2 = T&R Standard 2



### ELECTRICAL CHARACTERISTICS

AVX Part Number	V <sub>WDC</sub>	V <sub>WAC</sub>	V <sub>B</sub>	V <sub>C</sub>	I <sub>VC</sub>	I <sub>L</sub>	E <sub>T</sub>	E <sub>LD</sub>	I <sub>P</sub>	Cap	Freq	V <sub>JUMP</sub>	P <sub>DISS</sub>
VR15AT14A580	14.0	10.0	34.5±10%	60	1	10	0.1	0.15	30	120	K	27.5	0.002
VR15AT18A650	18.0	13.0	41.0±10%	67	1	10	0.1	0.15	30	90	M	29	0.002
VR20AT26D101	26.0	18.0	62.0±10%	100	1	10	0.4	1.5	100	225	K	48	0.008
VR20AT48S151	48.0	34.0	100.0±10%	150	1	10	2.0	3.5	250	275	K	48	0.040

V <sub>W(DC)</sub> V <sub>W(AC)</sub> V <sub>B</sub> V <sub>C</sub> I <sub>VC</sub> I <sub>L</sub>	DC Working Voltage [V] AC Working Voltage [V] Typical Breakdown Voltage [V @ 1mA <sub>DC</sub> ] Clamping Voltage [V @ I <sub>VC</sub> ] Test Current for V <sub>C</sub> Maximum leakage current at the working voltage [µA]	E <sub>T</sub> E <sub>LD</sub> I <sub>P</sub> Cap V <sub>JUMP</sub> P <sub>DISS</sub>	Transient Energy Rating [J, 10x1000µS] Load Dump Energy (x10) [J] Peak Current Rating [A, 8x20µS] Typical capacitance [pF] @ frequency specified and 0.5V <sub>RMS</sub> Jump Start (V) Power Dissipation (W)
---	---	--	--

### PHYSICAL DIMENSIONS

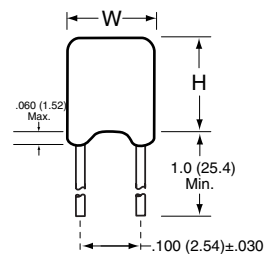

AVX Style	mm (inches)				
	Width (W)	Height (H)	Thickness (T)	Lead Spacing	Lead Diameter
VR15	4.32 Max. (0.170)	3.81 Max. (0.150)	2.54 Max. (0.100)	2.54 (0.100)	0.508 (0.020)
VR20	5.59 Max. (0.220)	5.08 Max. (0.200)	3.175 Max. (0.125)	2.54 (0.100)	0.508 (0.020)

### TYPICAL PERFORMANCE CURVES

Typical Voltage Current Characteristics

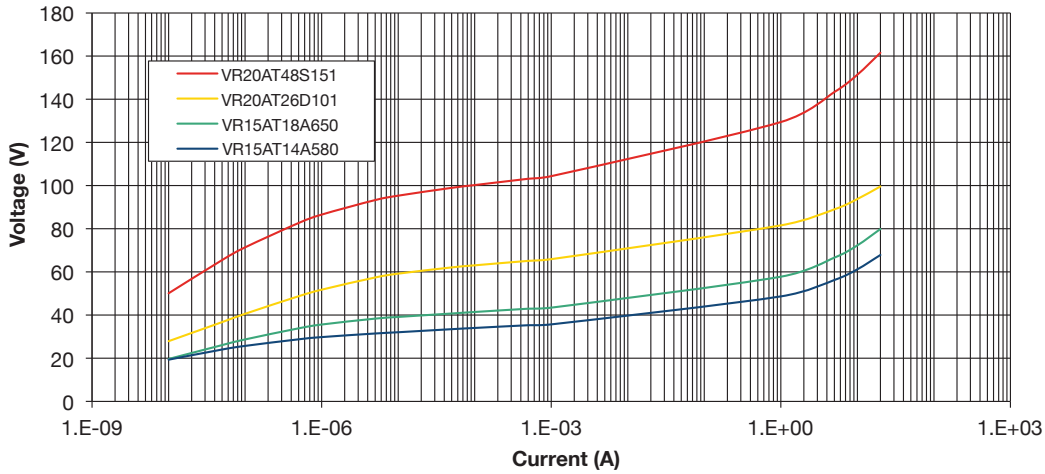

AEC-Q200-002 ESD Characteristics

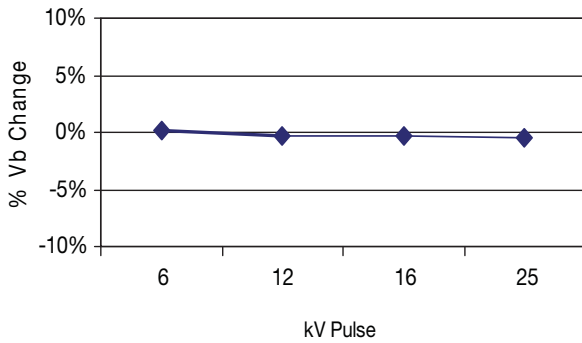

ESD Wave Absorption Characteristics

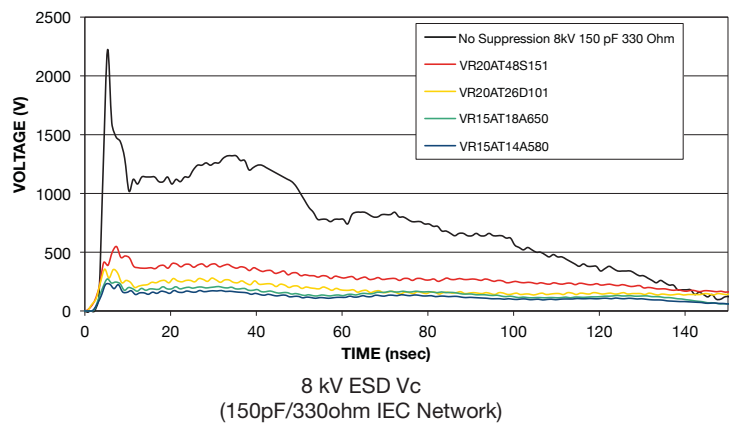

### TAPE & REEL PACKAGING OPTIONS

TR1

Tape & Reel Standard 1

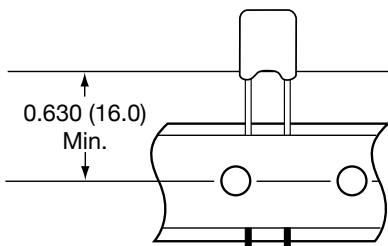

TR2

Tape & Reel Standard 2

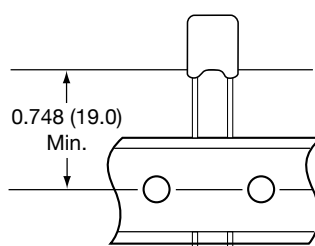



# Radial Leaded CapGuard®

## Varistor/Capacitor Combination for EMI/Surge Suppression



### GENERAL DESCRIPTION

AVX's radial leaded CapGuard® products are designed to provide both transient voltage protection and EMI/RFI suppression for electronic circuits. CapGuards® are ideally suited to filter out EMI/RFI noise generated by switch mode power supplies or motors on DC lines or I/O lines in electronic circuits. With multilayer varistor (MLV) utilized in CapGuard® product, effective transient voltage protection is achieved to protect sensitive electronics from high voltage transients. The capacitor, on the other hand, absorbs high frequency noise on the line. The MLCC capacitors are designed with temperature stable X7R dielectric, allowing for wide temperature use with good capacitance stability.

### GENERAL CHARACTERISTICS

- Operating Temperature: -55 to +125°C
- Working Voltage: 26Vdc, 45Vdc
- Capacitance: 0.47µF - 4.7µF

### FEATURES

- High Capacitance / EMI Filtering
- Bi-Directional Protection
- AEC Q200 qualified
- Multiple Strike Capability
- Radial, epoxy encapsulated

### APPLICATIONS

- EMI filtering with surge protection
- DC motors
- Inductive switching
- Relays
- Power supplies
- I/O Ports
- and more

### HOW TO ORDER

<b>CG</b> Series	<b>21</b> Size 21	<b>AS</b> Automotive Series	<b>26</b> Working Voltage 26 = 26Vdc 45 = 45Vdc	<b>F</b> Energy K = 0.6J F = 0.7J H = 1.2J	<b>474</b> Capacitance 474 = 0.47µF 105 = 1.0µF 475 = 4.7µF	<b>M</b> Tolerance M = ±20%	<b>R</b> Leads R = RoHS Compliant	<b>TR1</b> Packaging Blank = Bulk TR1 = T&R Standard 1 TR2 = T&R Standard 2
---------------------	-------------------------	--------------------------------	--	--	---	-----------------------------------	---	---



### ELECTRICAL CHARACTERISTICS

AVX Part Number	V <sub>WDC</sub>	V <sub>WAC</sub>	V <sub>B</sub>	V <sub>C</sub>	I <sub>VC</sub>	I <sub>L</sub>	E <sub>T</sub>	E <sub>LD</sub>	I <sub>P</sub>	Cap	Tol	V <sub>JUMP</sub>
CG21AS26F474MR	26.0	18.0	33.0±10%	54	1	15	0.7	1.5	200	0.47	±20%	27.5
CG21AS26F105MR	26.0	18.0	33.0±10%	54	1	15	0.7	1.5	200	1	±20%	27.5
CG21AS26H475MR	26.0	18.0	34.5±10%	60	5	15	1.2	3	300	4.7	±20%	27.5
CG21AS45K474MR	45.0	35.0	56.0±10%	90	1	15	0.6	1.25	200	0.47	±20%	48
CG21AS45K105MR	45.0	35.0	56.0±10%	90	1	15	0.6	1.25	200	1	±20%	48

- V<sub>w(DC)</sub> DC Working Voltage [V]
- V<sub>w(AC)</sub> AC Working Voltage [V]
- V<sub>B</sub> Typical Breakdown Voltage [V @ 1mA<sub>DC</sub>]
- V<sub>C</sub> Clamping Voltage [V @ I<sub>V</sub>]
- I<sub>VC</sub> Test Current for V<sub>C</sub>
- I<sub>L</sub> Maximum leakage current at the working voltage [µA]

- E<sub>T</sub> Transient Energy Rating [J, 10x1000µS]
- E<sub>LD</sub> Load Dump Energy (x10) [J]
- I<sub>P</sub> Peak Current Rating [A, 8x20µS]
- Cap Typical capacitance [pF] @ frequency specified and 0.5V<sub>RMS</sub>
- Tol Capacitance tolerance [%] from Typ value
- V<sub>JUMP</sub> Jump Start (V)

# Radial Leaded CapGuard®

## Varistor/Capacitor Combination for EMI/Surge Suppression



### PHYSICAL DIMENSIONS

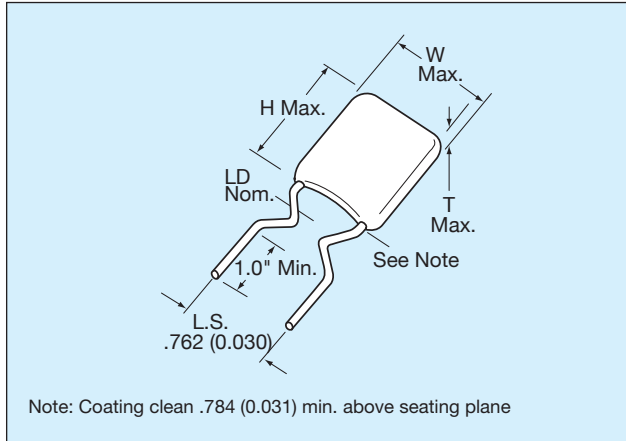

mm (inches)					
AVX Style	Width (W)	Height (H)	Thickness (T)	Lead Spacing	Lead Diameter
CG21	6.35 Max (0.250)	8.25 Max (0.325)	5.08 Max (0.200)	5.08±0.76 (0.200±0.030)	0.508 nom. (0.020)

### Schematic Diagram

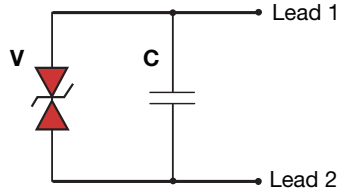

Drawings are for illustrative purposes only. Actual lead form shape could vary within stated tolerances based on body size.

### TAPE & REEL PACKAGING OPTIONS

#### TR1

Tape & Reel Standard 1

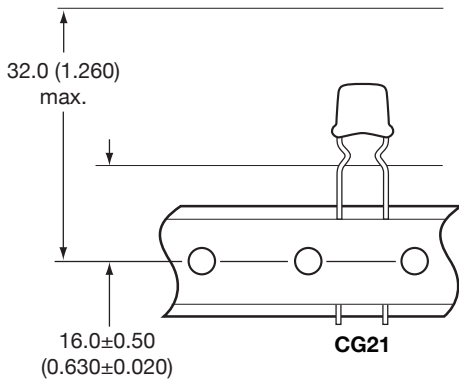

#### TR2

Tape & Reel Standard 2

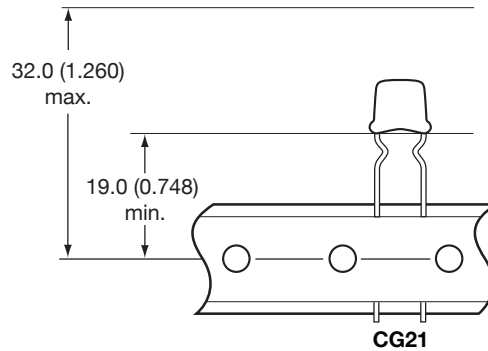

# Surface Mount CapGuard™

## Varistor/Capacitor Combination for EMI/Surge Suppression

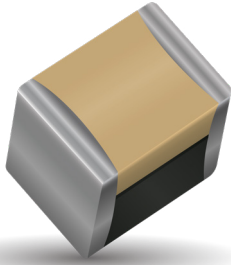

AVX's surface mount CapGuard™ products are designed to provide both transient voltage protection and EMI/RFI suppression for electronic circuits. CapGuards are ideally suited to filter out EMI/RFI noise generated by switch mode power supplies or motors on DC lines or I/O lines in electronic circuits. With multilayer varistor (MLV) utilized in CapGuard product, effective transient voltage protection is achieved to protect sensitive electronics from high voltage transients. The capacitor, on the other hand, absorbs high frequency noise on the line. The MLCC capacitors are designed with temperature stable X7R dielectric, allowing for wide temperature use with good capacitance stability. The surface mount CapGuards are characterized with a very small form factor to minimize board space. The parts are assembled using high melting point solder (268°C solidus / 290°C liquidus) allowing for standard reflow processing during board level assembly without a risk of reflowing HMP solder.

### HOW TO ORDER

<b>MV</b>	<b>10</b>	<b>18</b>	<b>J</b>	<b>104</b>	<b>M</b>	<b>A</b>	<b>A</b>	<b>1</b>
<b>Product Designation</b>	<b>Component Style</b>	<b>Working Voltage</b>	<b>Transient Energy Rating</b>	<b>Capacitance Code</b>	<b>Tolerance</b>	<b>Specification Code</b>	<b>Termination</b>	<b>Packaging</b>
MLCC/Varistor (MLV)	1210	18 = 18V 26 = 26V 48 = 48V 60 = 60V	J = 1.5 - 1.6J H = 1.2J	(2 significant digits + no. of zeros) Examples: 0.012µF = 123 0.047µF = 473 0.1µF = 104	M = ±20%	A = Standard	HMP	T&R

### PRODUCT OFFERING

	Operating Voltage (V)	Nominal Breakdown Voltage (V)	Breakdown Voltage Range (V)	Clamping Voltage (V)	Current for Clamping Voltage (Amp)	Transient Energy (J)	Peak Current (Amp)	Typical Capacitance (µF)
MV1018J123MAA1	18	25	23 - 28	42	5	1.6	500	0.012
MV1018J473MAA1	18	25	23 - 28	42	5	1.6	500	0.047
MV1018J104MAA1	18	25	23 - 28	42	5	1.6	500	0.1
MV1026H123MAA1	26	34.5	31 - 38	60	5	1.2	300	0.012
MV1026H473MAA1	26	34.5	31 - 38	60	5	1.2	300	0.047
MV1026H104MAA1	26	34.5	31 - 38	60	5	1.2	300	0.1
MV1048H123MAA1	48	62	55 - 69	100	5	1.2	250	0.012
MV1048H473MAA1	48	62	55 - 69	100	5	1.2	250	0.047
MV1048H104MAA1	48	62	55 - 69	100	5	1.2	250	0.1
MV1060J123MAA1	60	76	68 - 84	120	5	1.5	250	0.012
MV1060J473MAA1	60	76	68 - 84	120	5	1.5	250	0.047
MV1060J104MAA1	60	76	68 - 84	120	5	1.5	250	0.1

# Surface Mount CapGuard™

## Varistor/Capacitor Combination for EMI/Surge Suppression



### FEATURES

- High Capacitance / EMI Filtering
- Bi-Directional Protection
- Fast Turn-On Time
- Multiple Strike Capability
- HMP Solder Termination
- 1210 EIA Case Size

### TARGET APPLICATIONS

- Avionics, Military, I/O port protection
- EMI filtering with surge protection

### GENERAL CHARACTERISTICS

- Storage Temperature: -55°C to +125°C
- Operating Temperature: -55°C to +125°C

### TYPICAL VOLTAGE CURRENT RESPONSE

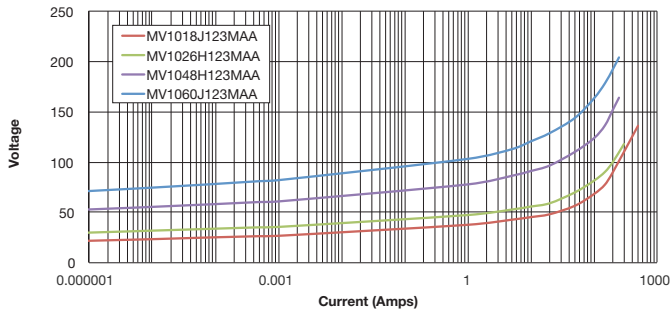

### TYPICAL PULSE POWER DURATION

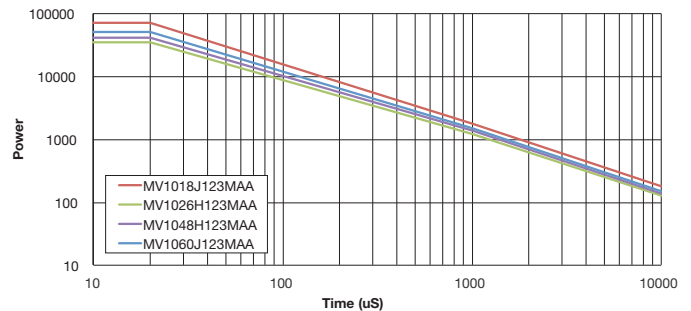

### TYPICAL HIGH FREQUENCY CHARACTERISTICS

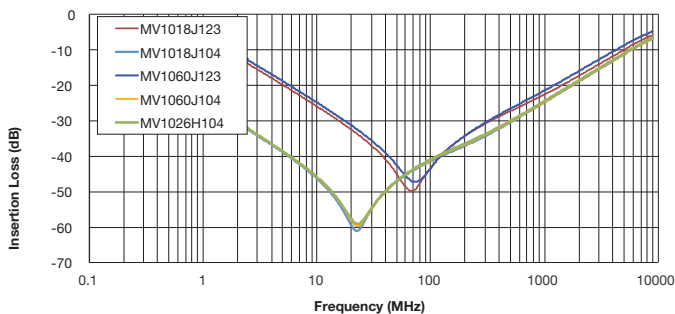

### DIMENSIONS

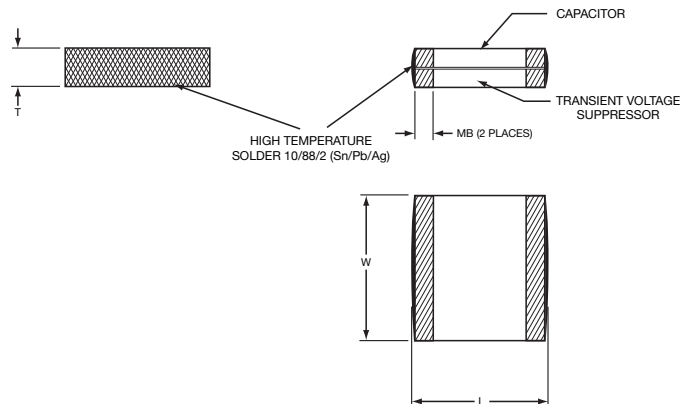

millimeters (inches)

Length (L)	Width (W)	Thickness (T)	Metallized Bands (MB)
3.302 ± 0.381 (0.130) ± (0.015)	2.540 ± 0.381 (0.100) ± (0.015)	2.794 (0.110) Max.	0.5 ± 0.25 (0.02) ± (0.01)

# Axial TransGuard® and StaticGuard

## AVX Axial Multilayer Ceramic Transient Voltage Suppressors

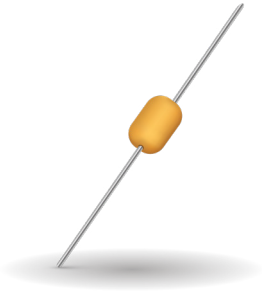

### GENERAL DESCRIPTION

Axial TransGuard® multilayer varistors are zinc oxide (ZnO) based ceramic semiconductor devices with non-linear voltage-current characteristics (bi-directional) similar to back-to-back zener diodes. They have the added advantage of greater current and energy handling capabilities as well as EMI/RFI attenuation.

Axial StaticGuard is low capacitance version of the TransGuard and are designed for general ESD protection of CMOS, Bi-Polar, and SiGe based systems.

AVX Axial varistors are designed for applications where leaded component is preferred and for durability in harsh environment.

### GENERAL CHARACTERISTICS

- Operating Temperatures: -55°C to +125°C
- Working Voltage: 3.3 - 60Vdc
- Case Size: Axial
- Energy: 0.1 - 2.0J
- Peak Current: 30 - 300A

### FEATURES

- Axial leaded, epoxy encapsulated
- Fast Response
- EMI/RFI filtering in the off-state
- Multiple strikes capability

### APPLICATIONS

- White Goods
- Industrial Equipment
- Sensors
- Relays
- DC Motors
- and more

### HOW TO ORDER - AXIAL TRANSGUARD®

<b>VA</b> ┆ ┆	<b>1000</b> ┆ ┆	<b>26</b> ┆ ┆	<b>D</b> ┆ ┆	<b>400</b> ┆ ┆	<b>R</b> ┆ ┆	<b>L</b> ┆ ┆
<b>Varistor Axial</b>	<b>Case Size</b>	<b>Voltage</b>	<b>Energy Rating</b>	<b>Clamping Voltage</b>	<b>Packaging</b>	<b>Termination</b>
	1000 2000	03 = 3.3Vdc 05 = 5.6Vdc 14 = 14Vdc 18 = 18Vdc 26 = 26Vdc 30 = 30Vdc 48 = 48Vdc 60 = 60Vdc	A = 0.1J D = 0.4J K = 0.6J	100 = 12V 150 = 18V 300 = 32V 400 = 42V 580 = 60V 650 = 67V 101 = 100V 121 = 120V	D = 7" reel R = 7" reel T = 13" reel	L = Ni/Sn plated



Packaging (Pcs/Reel:			
STYLE	D	R	T
VA1000	1,000	3,000	7,500
VA2000	1,000	2,500	5,000

### HOW TO ORDER - AXIAL STATICGUARD

<b>VA</b> ┆ ┆	<b>10</b> ┆ ┆	<b>LC</b> ┆ ┆	<b>18</b> ┆ ┆	<b>A</b> ┆ ┆	<b>500</b> ┆ ┆	<b>R</b> ┆ ┆	<b>L</b> ┆ ┆
<b>Varistor Axial</b>	<b>Case Size</b>	<b>Low Capacitance</b>	<b>Voltage</b>	<b>Energy Rating</b>	<b>Clamping Voltage</b>	<b>Packaging</b>	<b>Termination</b>
	10 = 1000		18 = 18Vdc	A = 0.1J	500 = 50V	D = 7" reel R = 7" reel T = 13" reel	L = Ni/Sn plated

# Axial TransGuard® and StaticGuard

## AVX Axial Multilayer Ceramic Transient Voltage Suppressors



### AXIAL TRANSGUARD®

AVX PN	V <sub>w</sub> (DC)	V <sub>w</sub> (AC)	V <sub>B</sub>	V <sub>c</sub>	I <sub>vc</sub>	I <sub>L</sub>	E <sub>T</sub>	I <sub>p</sub>	Cap	Freq	Case
VA100003A100	3.3	2.3	5.0±20%	12	1	100	0.1	40	1500	K	1000
VA100003D100	3.3	2.3	5.0±20%	12	1	100	0.4	150	4700	K	1000
VA100005A150	5.6	4.0	8.5±20%	18	1	35	0.1	40	1000	K	1000
VA100005D150	5.6	4.0	8.5±20%	18	1	35	0.4	150	2800	K	1000
VA100014A300	14.0	10.0	18.5±12%	32	1	15	0.1	40	325	K	1000
VA100014D300	14.0	10.0	18.5±12%	32	1	15	0.4	150	1100	K	1000
VA100018A400	18.0	13.0	25.5±10%	42	1	10	0.1	40	350	K	1000
VA100018D400	18.0	13.0	25.5±10%	42	1	10	0.4	150	900	K	1000
VA100026D580	26.0	18.0	34.5±10%	60	1	10	0.4	120	650	K	1000
VA100030D650	30.0	21.0	41.0±10%	67	1	10	0.4	120	550	K	1000
VA100048D101	48.0	34.0	62.0±10%	100	1	10	0.4	100	200	K	1000
VA200060K121	60.0	42.0	76.0±10%	120	1	10	2.0	300	400	K	2000

### AXIAL STATICGUARD

AVX PN	V <sub>w</sub> (DC)	V <sub>w</sub> (AC)	V <sub>B</sub>	V <sub>c</sub>	I <sub>vc</sub>	I <sub>L</sub>	E <sub>T</sub>	I <sub>p</sub>	Cap	Freq	Case
VA10LC18A500	≤18.0	≤14.0	25-40	50	1	10	0.1	30	200	K	1000

- V<sub>w</sub>(DC) DC Working Voltage [V]
- V<sub>w</sub>(AC) AC Working Voltage [V]
- V<sub>B</sub> Typical Breakdown Voltage (V @ 1mA<sub>DC</sub>)
- V<sub>B Tol</sub> V<sub>B</sub> Tolerance is ± from Typical Value
- V<sub>c</sub> Clamping Voltage (V @ I<sub>vc</sub>)
- I<sub>vc</sub> Test Current for V<sub>c</sub> (A, 8x20μS)
- I<sub>L</sub> Maximum Leakage Current at the Working Voltage (μA)
- E<sub>T</sub> Transient Energy Rating (J, 10x1000μS)
- I<sub>p</sub> Peak Current Rating (A, 8x20μS)
- Cap Typical Capacitance (pF) @ frequency specified and 0.5 V<sub>RMS</sub>
- Freq Frequency at which capacitance is measured (K = 1kHz, M = 1MHz)

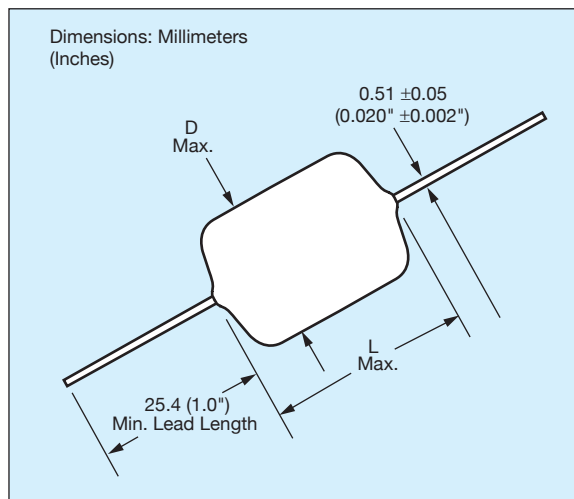

### DIMENSIONS:

mm (inches)

AVX Style		VA1000	VA2000
(L) Max Length	mm (in.)	4.32 (0.170)	4.83 (0.190)
(D) Max Diameter	mm (in.)	2.54 (0.100)	3.56 (0.140)

Lead Finish: Copper Clad Steel, Solder Coated



The Important Information/Disclaimer is incorporated in the catalog where these specifications came from or available online at [www.avx.com/disclaimer/](http://www.avx.com/disclaimer/) by reference and should be reviewed in full before placing any order.

### GENERAL DESCRIPTION

AVX has combined the best electrical characteristics of its TransGuard® Transient Voltage Suppressors (TVS) and its Feedthru Capacitors into a single chip for state-of-the-art overvoltage circuit protection and EMI reduction over a broad range of frequencies. This unique combination of multilayer ceramic construction in a feedthru configuration gives the circuit designer a single 0805 chip that responds to transient events faster than any TVS device on the market today, and provides significant EMI attenuation when in the off-state.

The reduction in parallel inductance, typical of the feedthru chip construction when compared to the construction of standard TVS or ceramic capacitor chips, gives the TransFeed® product two very important electrical advantages: (1) faster “turn-on” time. Calculated response times of <200 pSec are not unusual with this device, and measured response times range from 200 – 250 pSec. The TransFeed® “turn-on” characteristic is less than half that of an equivalent TransGuard® part – and TransGuards® clamp transient voltages faster than any other bipolar TVS solution such as diodes; (2) the second electrical advantage of lower parallel inductance, coupled with optimal series inductance, is the enhanced attenuation characteristics of the TransFeed® product. Not only is there significantly greater attenuation at a higher self-resonance frequency, but the roll-off characteristic becomes much flatter, resulting in EMI filtering over a much broader frequency spectrum. Typical applications include filtering/protection on Microcontroller I/O Lines, Interface I/O Lines, Power Line Conditioning and Power Regulation.

### TYPICAL APPLICATIONS

- Fingerprint ID Circuit
- Magnetic Field Circuit
- LCD Dashboard Driver

Where designers are concerned with both transient voltage protection and EMI attenuation, either due to the electrical performance of their circuits or due to required compliance to specific EMC regulations, the TransFeed® product is an ideal choice.

### APPLICATIONS

- Bi-directional TVS
- Narrow band, high attenuation filter
- EMI Filtering over broader frequency range
- Fastest Response Time to ESD Strikes

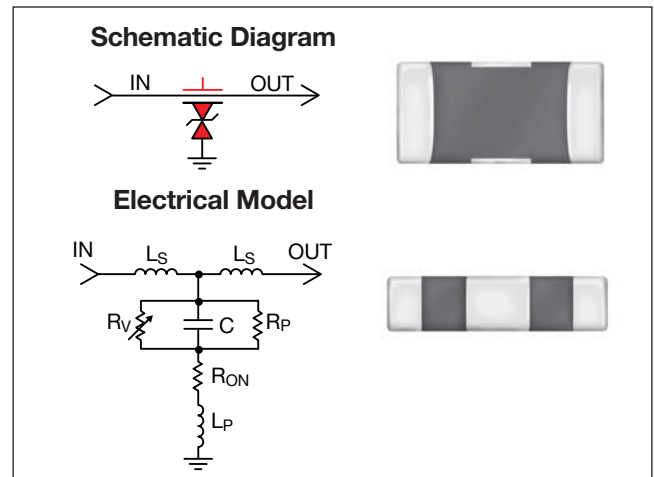

### GENERAL CHARACTERISTICS

- Operating Temperature: -55°C to +125°C
- Working Voltage: 5.6Vdc - 26 Vdc
- Case Size: 0805
- Energy Rating: 0.05 - 0.3J
- Current: 20 - 120A
- Max Feedthru Current: 0.5 - 1A

### HOW TO ORDER

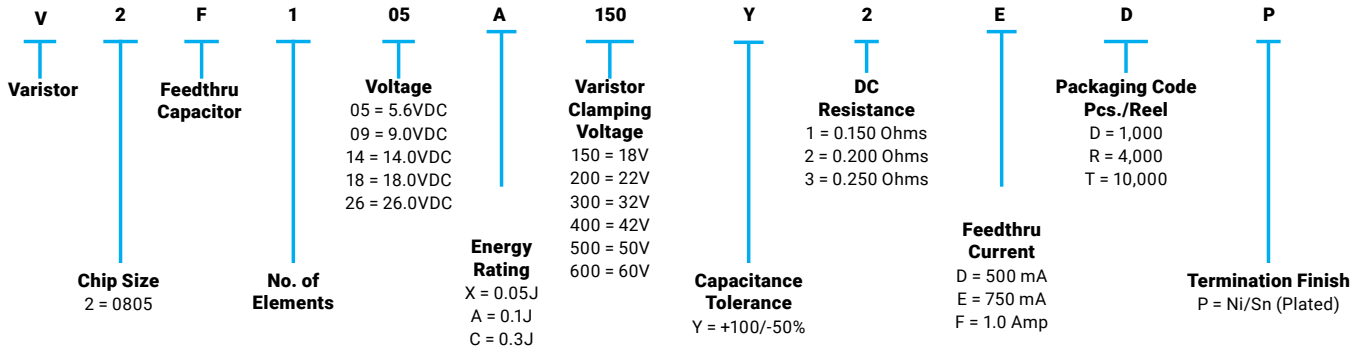

### TRANSFEED ELECTRICAL SPECIFICATIONS

AVX Part Number	Working Voltage (DC)	Working Voltage (AC)	Breakdown Voltage	Clamping Voltage	Maximum Leakage Current	Transient Energy Rating	Peak Current Rating	Typical Cap	DC Resistance	Maximum Feedthru Current
V2F105A150Y2E__	5.6	4.0	8.5±20%	18	35	0.10	30	800	0.200	0.75
V2F105C150Y1F__	5.6	4.0	8.5±20%	18	35	0.30	120	2500	0.150	1.00
V2F109A200Y2E__	9.0	6.4	12.7±15%	22	25	0.10	30	575	0.200	0.75
V2F109C200Y1F__	9.0	6.4	12.7±15%	22	25	0.30	120	1800	0.150	1.00
V2F114A300Y2E__	14.0	10.0	18.5±12%	32	15	0.10	30	300	0.200	0.75
V2F114C300Y1F__	14.0	10.0	18.5±12%	32	15	0.30	120	900	0.150	1.00
V2F118A400Y2E__	18.0	13.0	25.5±10%	42	10	0.10	30	200	0.200	0.75
V2F118C400Y1F__	18.0	13.0	25.5±10%	42	10	0.30	120	500	0.150	1.00
V2F118X500Y3D__	18.0	13.0	25.5±10%	50	10	0.05	20	75	0.250	0.50
V2F126C600Y2E__	26.0	18.0	34.5±10%	60	10	0.3	80	250	0.2	0.75

Termination Finish Code  
Packaging Code

$V_w$ (DC)	DC Working Voltage (V)	$I_p$	Peak Current Rating (A, 8x20µS)
$V_w$ (AC)	AC Working Voltage (V)	Cap	Typical Capacitance (pF) @ 1MHz and 0.5 V
$V_B$	Typical Breakdown Voltage (V @ 1mA DC)	DCR	DC Resistance (Ohms)
$V_B$ Tol	VB Tolerance is ± from Typical Value	$I_{FT}$	Maximum Feedthru Current (A)
$V_C$	Clamping Voltage (V @ 1A 8x20µS)		
$I_L$	Maximum Leakage Current at the Working Voltage (µA)		
$E_T$	Transient Energy Rating (J, 10x1000µS)		



dB Attenuation vs Frequency

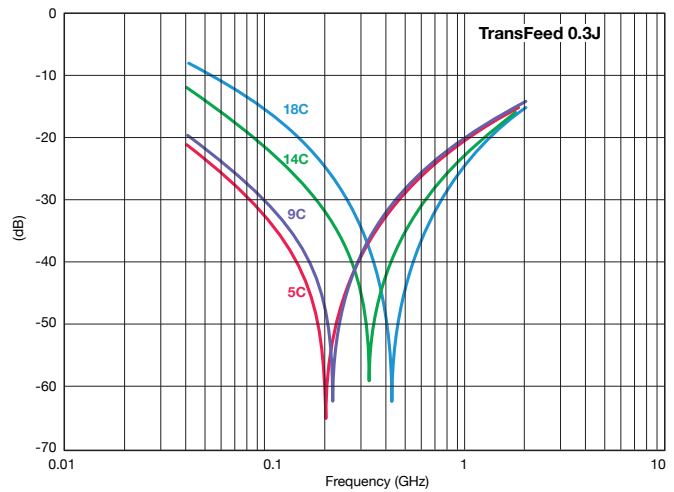
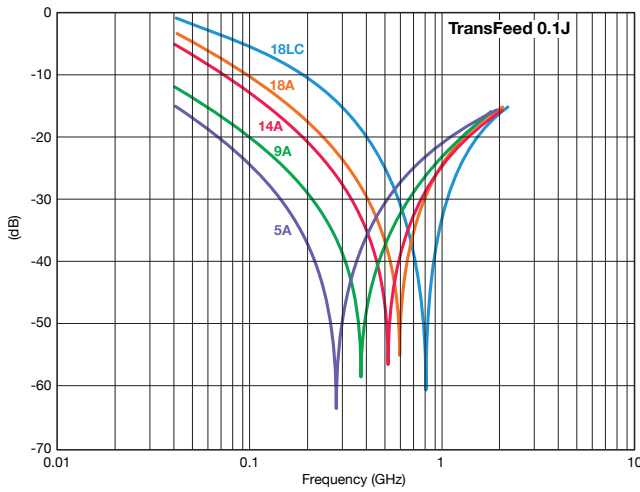

### DIMENSIONS

	L	W	T	BW	BL	EW	X	S
0805	2.01 ± 0.20 (0.079 ± 0.008)	1.25 ± 0.20 (0.049 ± 0.008)	1.143 Max. (0.045 Max.)	0.46 ± 0.10 (0.018 ± 0.004)	0.18 + 0.25 - 0.08 (0.007 + 0.010 - 0.003)	0.25 ± 0.13 (0.010 ± 0.005)	1.02 ± 0.10 (0.040 ± 0.004)	0.23 ± 0.05 (0.009 ± 0.002)

### RECOMMENDED SOLDER PAD LAYOUT (Typical Dimensions)

	T	P	S	W	L	C
0805	3.45 (0.136)	0.51 (0.020)	0.76 (0.030)	1.27 (0.050)	1.02 (0.040)	0.46 (0.018)

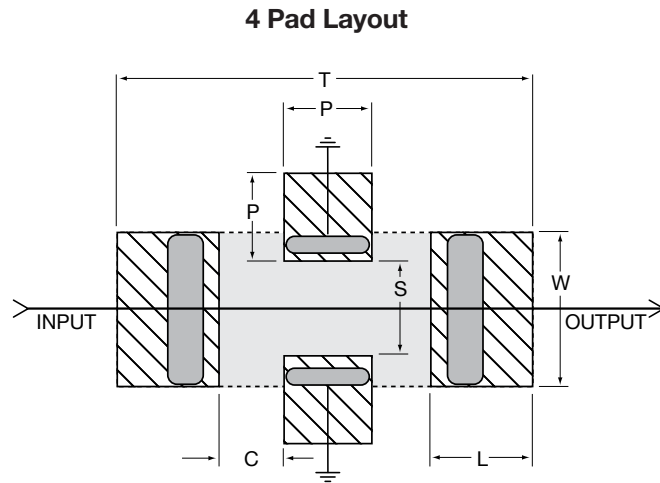
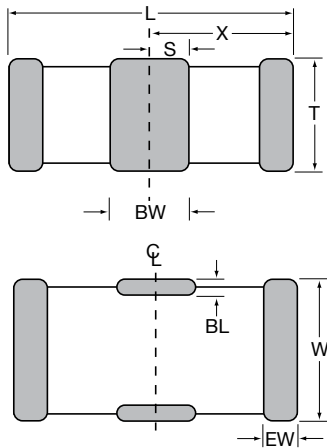

**PERFORMANCE CHARACTERISTICS**

**INSERTION LOSS COMPARISON  
(TRANSEED® VS TRANSGUARD®)  
0805 – DB VS FREQUENCY**

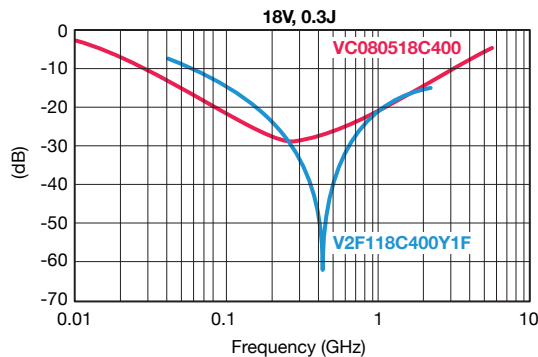
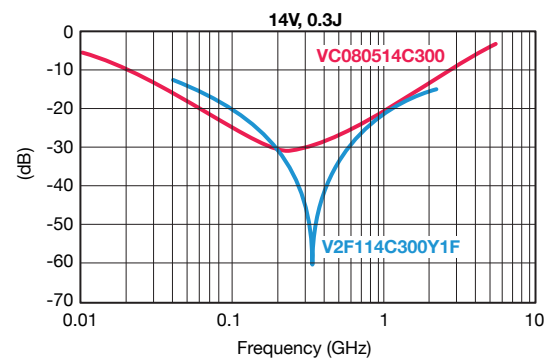
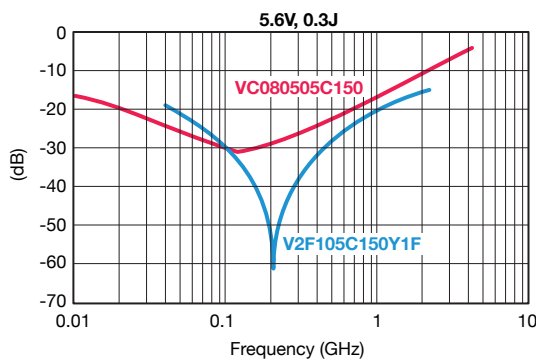
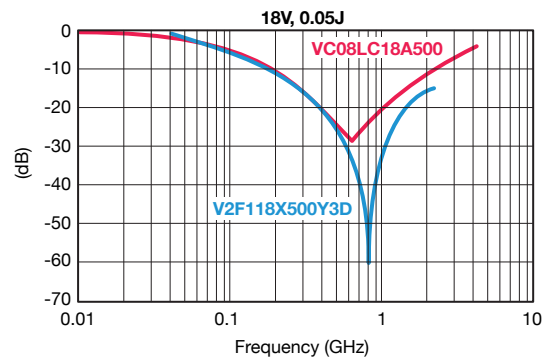
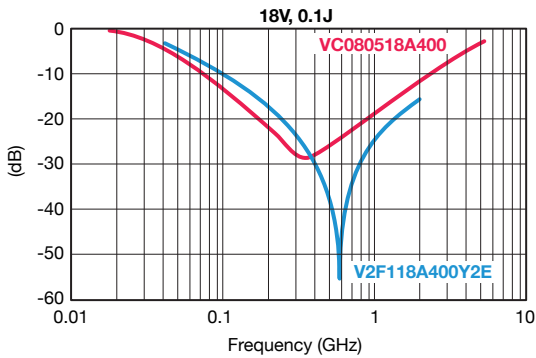
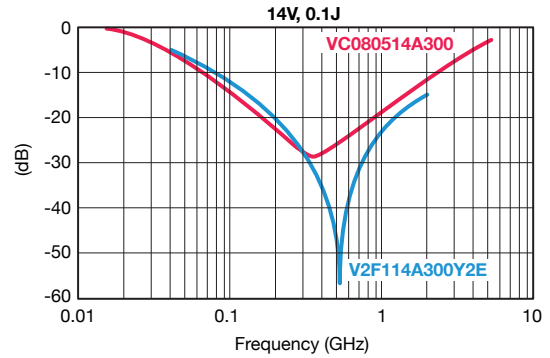
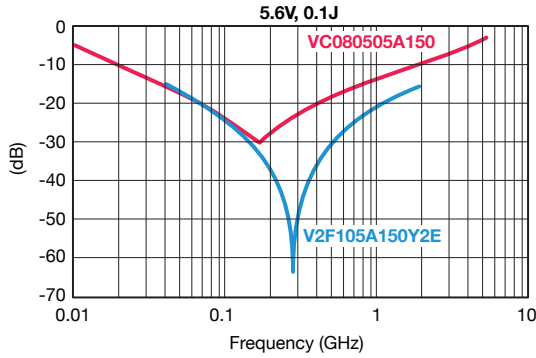

**PERFORMANCE CHARACTERISTICS**

**CURRENT VS TEMPERATURE**

**0805 – 0.1 JOULE**

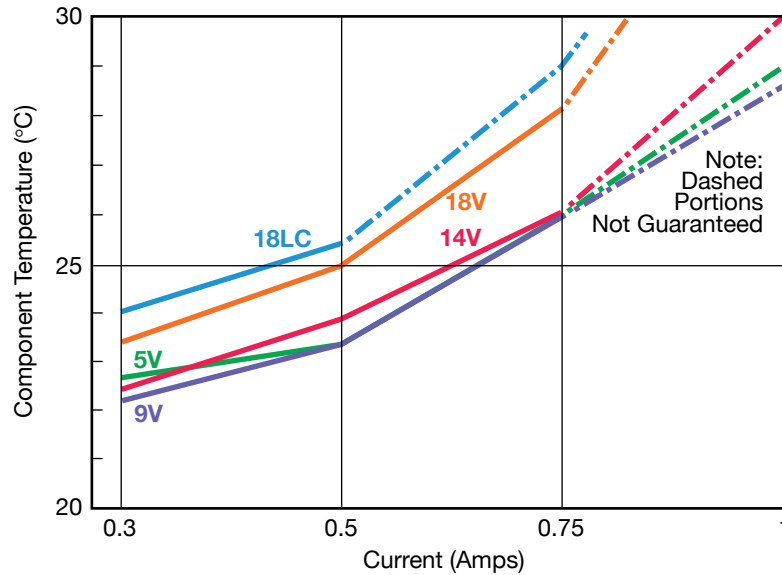

**CURRENT VS TEMPERATURE**

**0805 – 0.3 JOULE**

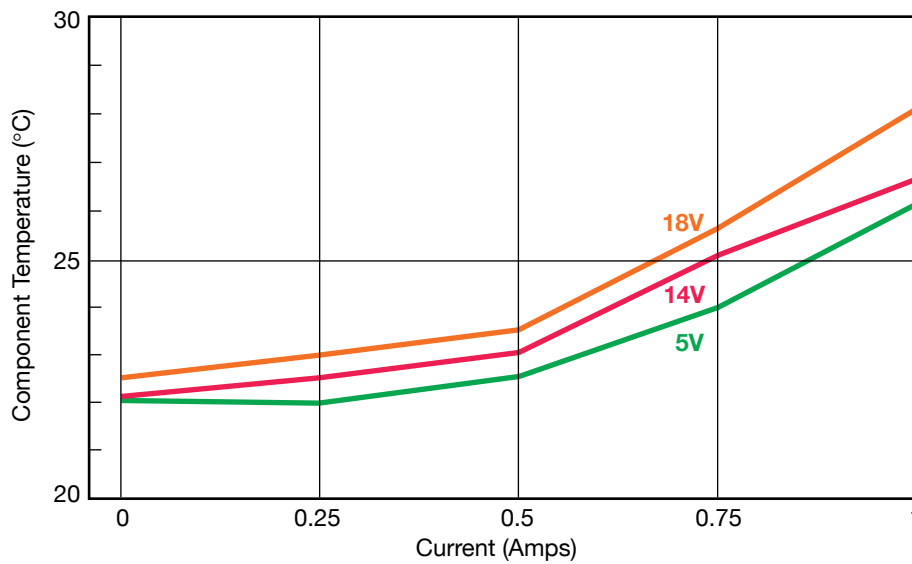

**PERFORMANCE CHARACTERISTICS**

**FEEDTHRU VARISTORS**

AVX Multilayer Feedthru Varistors (MLVF) are an ideal choice for system designers with transient strike and broadband EMI/RFI concerns.

Feedthru Varistors utilize a ZnO varistor material and the electrode pattern of a feedthru capacitor. This combination allows the package advantage of the feedthru and material advantages of the ZnO dielectric to be optimized.

ZnO MLV Feedthrus exhibit electrical and physical advantages over standard ZnO MLVs. Among them are:

1. Faster Turn on Time
2. Broadband EMI attenuation
3. Small size (relative to discrete MLV and EMI filter schemes)

The electrical model for a ZnO MLV and a ZnO Feedthru MLV are shown below. The key difference in the model for the Feedthru is a transformation in parallel to series inductance. The added series inductance helps lower the injected transient peak current (by  $2\pi fL$ ) resulting in an additional benefit of a lower clamping voltage. The lowered parallel inductance decreases the turn on time for the varistor to  $<250\text{ps}$ .

**Discrete MLV Model**

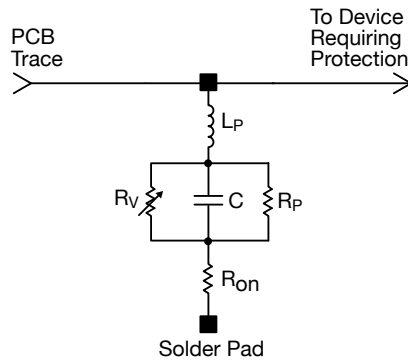

**Discrete MLVF Model**

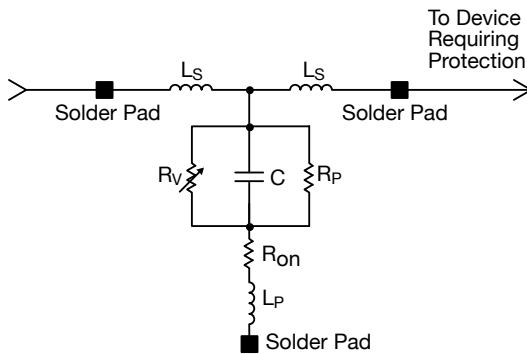

Where:  $R_v$  = Voltage Variable resistance (per VI curve)  
 $R_p \geq 10^{12} \Omega$   
 $C$  = defined by voltage rating and energy level  
 $R_{on}$  = turn on resistance  
 $L_p$  = parallel body inductance

Where:  $R_v$  = Voltage Variable resistance (per VI curve)  
 $R_p \geq \text{Body IR}$   
 $C$  = defined by voltage rating and energy level  
 $R_{on}$  = turn on resistance  
 $L_p$  = minimized parallel body inductance  
 $L_s$  = series body inductance

### PERFORMANCE CHARACTERISTICS

#### APPLICATIONS

- EMI Suppression
- Broadband I/O Filtering
- Vcc Line Conditioning

#### FEATURES

- Small Size
- Low ESR
- Ultra-fast Response Time
- Broad S21 Characteristics

#### MARKET SEGMENTS

- Computers
- Automotive
- Power Supplies
- Multimedia Add-On Cards
- Bar Code Scanners
- Remote Terminals
- Medical Instrumentation
- Test Equipment
- Transceivers
- Cellular Phones / Pagers

#### TYPICAL CIRCUITS REQUIRING TRANSIENT VOLTAGE PROTECTION AND EMI FILTERING

The following applications and schematic diagrams show where TransFeed® TVS/ EMI filtering devices might be used:

- System Board Level Interfaces: (Fig. 1)  
Digital to RF  
Analog to Digital  
Digital to Analog
- Voltage Regulation (Fig. 2)
- Power Conversion Circuits (Fig. 3)
- GaAs FET Protection (Fig. 4)

Fig. 1 – System Interface

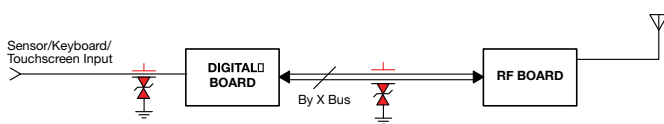

Fig. 2 – Voltage Regulators

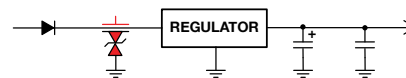

Fig. 3 – Power Conversion Circuits/Power Switching Circuits

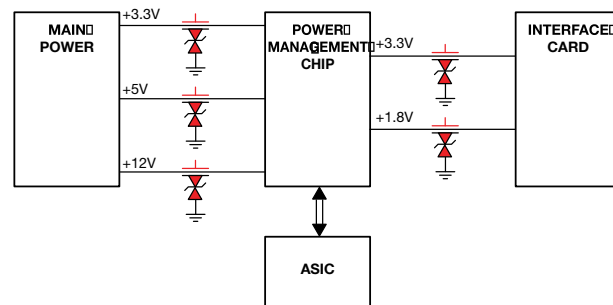
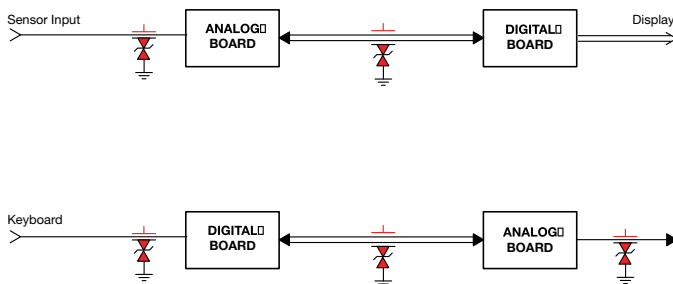
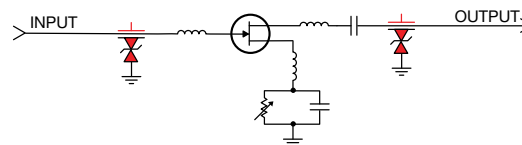

Fig. 4 – GaAs FET Protection



### SPECIFICATION COMPARISON

MLVF 0805	PARAMETER		MLV 0805
5ph	Ls	typical	N/A
<600nh	Lp	typical	<1.5nh
<0.025Ω	Ron	typical	<0.1Ω
100pf to 2.5nf	C	typical	100pf to 5.5nf
see VI curves	Rv	typical	see VI curves
>0.25 x 1012Ω	Rp	typical	>1 x 1012Ω
<250ps	Typical turn on time Typical frequency response		<500ps

A comparison table showing typical element parameters and resulting performance features for MLV and MLVF is shown above.

# TransFeed® Automotive Series

## AVX Multilayer Ceramic Transient Voltage Suppressors TVS Protection and EMI Attenuation in a Single Chip



### GENERAL DESCRIPTION

AVX has combined the best electrical characteristics of its TransGuard® Transient Voltage Suppressors (TVS) and its Feedthru Capacitors into a single chip for state-of-the-art overvoltage circuit protection and EMI reduction over a broad range of frequencies. This unique combination of multilayer ceramic construction in a feedthru configuration gives the circuit designer a single 0805 chip that responds to transient events faster than any TVS device on the market today, and provides significant EMI attenuation when in the off-state.

Automotive TransFeed® is designed for automotive applications and are AEC-Q 200 qualified.

The reduction in parallel inductance, typical of the feedthru chip construction when compared to the construction of standard TVS or ceramic capacitor chips, gives the TransFeed® product two very important electrical advantages: (1) faster "turn-on" time. Calculated response times of <200 pSec are not unusual with this device, and measured response times range from 200 – 250 pSec. The TransFeed® "turn-on" characteristic is less than half that of an equivalent TransGuard® part – and TransGuards® clamp transient voltages faster than any other bipolar TVS solution such as diodes; (2) the second electrical advantage of lower parallel inductance, coupled with optimal series inductance, is the enhanced attenuation characteristics of the TransFeed® product. Not only is there significantly greater attenuation at a higher self-resonance frequency, but the roll-off characteristic becomes much flatter, resulting in EMI filtering over a much broader frequency spectrum. Typical applications include filtering/protection on Microcontroller I/O Lines, Interface I/O Lines, Power Line Conditioning and Power Regulation.

### TYPICAL APPLICATIONS

- Drive by Wire
- Dimming Mirror Circuit
- Filtering/protection on Microcontroller I/O lines
- Filtering/protection on Interface I/O lines
- Power Line Conditioning
- Power Regulation
- LCD Dashboard driver

Where designers are concerned with both transient voltage protection and EMI attenuation, either due to the electrical performance of their circuits or due to required compliance to specific EMC regulations, the TransFeed product is an ideal choice.

### FEATURES

- Bi-directional TVS
- Narrow band, high attenuation filter
- EMI Filtering over broader frequency range
- Fastest Response Time to ESD Strikes
- AEC-Q 200 Qualified

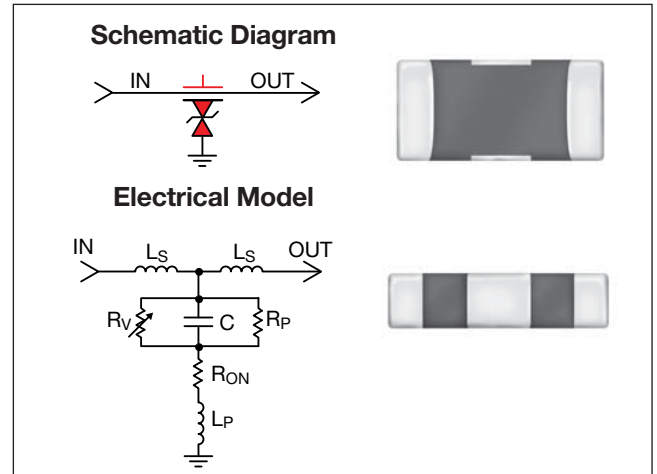

### GENERAL CHARACTERISTICS

- Operating Temperature: -55°C to +125°C
- Working Voltage: 5.6Vdc - 26Vdc
- Case Size: 0805
- Energy Rating: 0.05 - 0.3J
- Current: 20 - 120A
- Max Feedthru Current: 0.5 - 1A

# TransFeed® Automotive Series

## AVX Multilayer Ceramic Transient Voltage Suppressors TVS Protection and EMI Attenuation in a Single Chip



### HOW TO ORDER

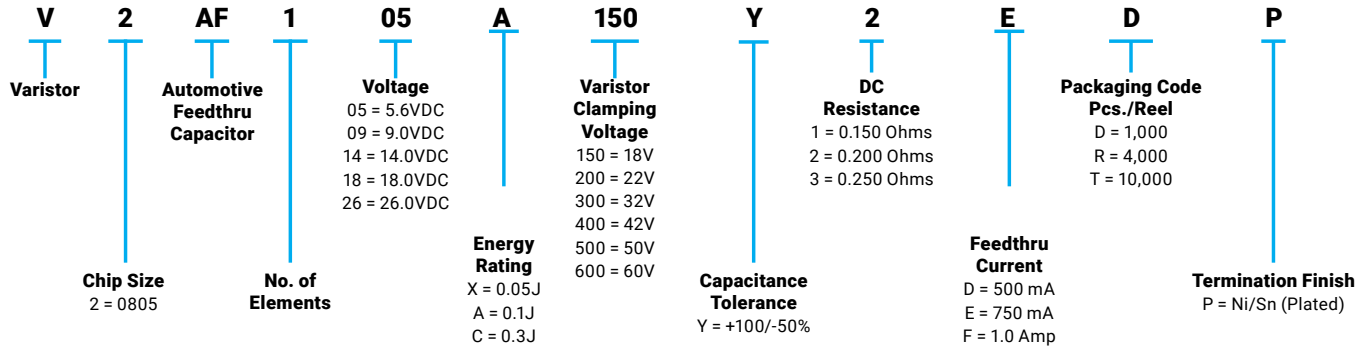

### TRANSFEED ELECTRICAL SPECIFICATIONS

AVX Part Number	Working Voltage (DC)	Working Voltage (AC)	Breakdown Voltage	Clamping Voltage	Maximum Leakage Current	Transient Energy Rating	Peak Current Rating	Typical Cap	DC Resistance	Maximum Feedthru Current	Jump Start Voltage
V2AF105A150Y2E__	5.6	4.0	8.5±20%	18	35	0.10	30	800	0.200	0.75	-
V2AF105C150Y1F__	5.6	4.0	8.5±20%	18	35	0.30	120	2500	0.150	1.00	-
V2AF109A200Y2E__	9.0	6.4	12.7±15%	22	25	0.10	30	575	0.200	0.75	-
V2AF109C200Y1F__	9.0	6.4	12.7±15%	22	25	0.30	120	1800	0.150	1.00	-
V2AF114A300Y2E__	14.0	10.0	18.5±12%	32	15	0.10	30	300	0.200	0.75	27.5
V2AF114C300Y1F__	14.0	10.0	18.5±12%	32	15	0.30	120	900	0.150	1.00	27.5
V2AF118A400Y2E__	18.0	13.0	25.5±10%	42	10	0.10	30	200	0.200	0.75	27.5
V2AF118C400Y1F__	18.0	13.0	25.5±10%	42	10	0.30	120	500	0.150	1.00	27.5
V2AF118X500Y3D__	18.0	13.0	25.5±10%	50	10	0.05	20	75	0.250	0.50	27.5
V2AF126C600Y2E__	26.0	18.0	34.5±10%	60	10	0.3	80	250	0.2	0.75	27.5

└ Termination Finish Code  
└ Packaging Code

V <sub>w</sub> (DC)	DC Working Voltage (V)	E <sub>T</sub>	Transient Energy Rating (J, 10x1000µS)
V <sub>w</sub> (AC)	AC Working Voltage (V)	I <sub>p</sub>	Peak Current Rating (A, 8x20µS)
V <sub>B</sub>	Typical Breakdown Voltage (V @ 1mA <sub>DC</sub> )	Cap	Typical Capacitance (pF) @ 1MHz and 0.5 V
V <sub>B Tol</sub>	V <sub>B</sub> Tolerance is ± from Typical Value	DCR	DC Resistance (Ohms)
V <sub>C</sub>	Clamping Voltage (V @ 1A 8x20µS)	I <sub>FT</sub>	Maximum Feedthru Current (A)
IL	Maximum Leakage Current at the Working Voltage (µA)	V <sub>JUMP</sub>	Jump Start Voltage (V, 5 min)

# TransFeed® Automotive Series

## AVX Multilayer Ceramic Transient Voltage Suppressors TVS Protection and EMI Attenuation in a Single Chip



### DIMENSIONS

mm (inches)

	L	W	T	BW	BL	EW	X	S
0805	2.01 ± 0.20 (0.079 ± 0.008)	1.25 ± 0.20 (0.049 ± 0.008)	1.143 Max. (0.045 Max.)	0.46 ± 0.10 (0.018 ± 0.004)	0.18 + 0.25 - 0.08 (0.007 + 0.010 - 0.003)	0.25 ± 0.13 (0.010 ± 0.005)	1.02 ± 0.10 (0.040 ± 0.004)	0.23 ± 0.05 (0.009 ± 0.002)

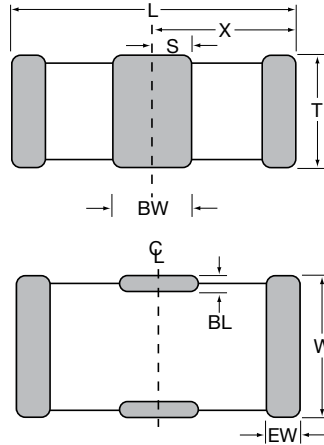

### RECOMMENDED SOLDER PAD LAYOUT (TYPICAL DIMENSIONS)

mm (inches)

	T	P	S	W	L	C
0805	3.45 (0.136)	0.51 (0.020)	0.76 (0.030)	1.27 (0.050)	1.02 (0.040)	0.46 (0.018)

#### 4 Pad Layout

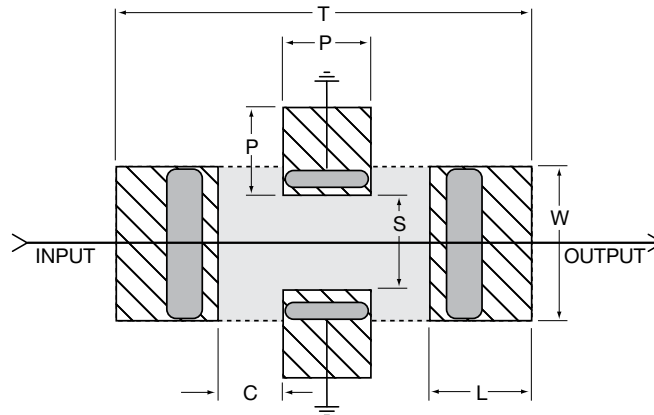



**PERFORMANCE CHARACTERISTICS**

**FEEDTHRU VARISTORS**

AVX Multilayer Feedthru Varistors (MLVF) are an ideal choice for system designers with transient strike and broadband EMI/RFI concerns.

Feedthru Varistors utilize a ZnO varistor material and the electrode pattern of a feedthru capacitor. This combination allows the package advantage of the feedthru and material advantages of the ZnO dielectric to be optimized.

ZnO MLV Feedthrus exhibit electrical and physical advantages over standard ZnO MLVs. Among them are:

1. Faster Turn on Time
2. Broadband EMI attenuation
3. Small size (relative to discrete MLV and EMI filter schemes)

The electrical model for a ZnO MLV and a ZnO Feedthru MLV are shown below. The key difference in the model for the Feedthru is a transformation in parallel to series inductance. The added series inductance helps lower the injected transient peak current (by  $2\pi fL$ ) resulting in an additional benefit of a lower clamping voltage. The lowered parallel inductance decreases the turn on time for the varistor to <250ps.

**Discrete MLV Model**

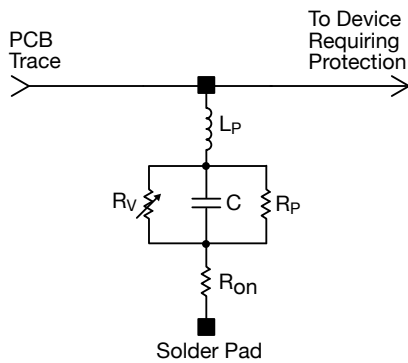

Where:  $R_v$  = Voltage Variable resistance (per VI curve)  
 $R_p \geq 1012 \Omega$   
 $C$  = defined by voltage rating and energy level  
 $R_{on}$  = turn on resistance  
 $L_p$  = parallel body inductance

**Discrete MLVF Model**

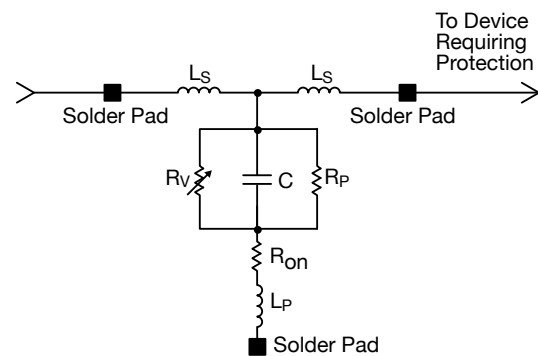

Where:  $R_v$  = Voltage Variable resistance (per VI curve)  
 $R_p \geq$  Body IR  
 $C$  = defined by voltage rating and energy level  
 $R_{on}$  = turn on resistance  
 $L_p$  = minimized parallel body inductance  
 $L_s$  = series body inductance

# TransFeed® Automotive Series

## AVX Multilayer Ceramic Transient Voltage Suppressors

### TVS Protection and EMI Attenuation in a Single Chip



## PERFORMANCE CHARACTERISTICS

### APPLICATIONS

- EMI Suppression
- Broadband I/O Filtering
- Vcc Line Conditioning

### FEATURES

- Small Size
- Low ESR
- Ultra-fast Response Time
- Broad S21 Characteristics

### MARKET SEGMENTS

- Computers
- Automotive
- Power Supplies
- Multimedia Add-On Cards
- Bar Code Scanners
- Remote Terminals
- Medical Instrumentation
- Test Equipment
- Transceivers
- Cellular Phones / Pagers

### TYPICAL CIRCUITS REQUIRING TRANSIENT VOLTAGE PROTECTION AND EMI FILTERING

The following applications and schematic diagrams show where TransFeed® TVS/ EMI filtering devices might be used:

- System Board Level Interfaces: (Fig. 1)
  - Digital to RF
  - Analog to Digital
  - Digital to Analog
- Voltage Regulation (Fig. 2)
- Power Conversion Circuits (Fig. 3)
- GaAs FET Protection (Fig. 4)

Fig. 1 – System Interface

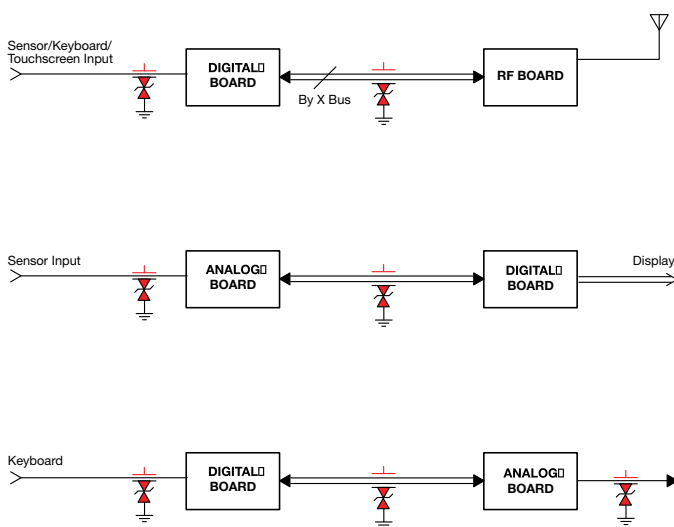

Fig. 2 – Voltage Regulators

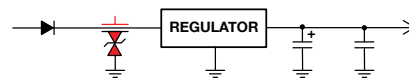

Fig. 3 – Power Conversion Circuits/Power Switching Circuits

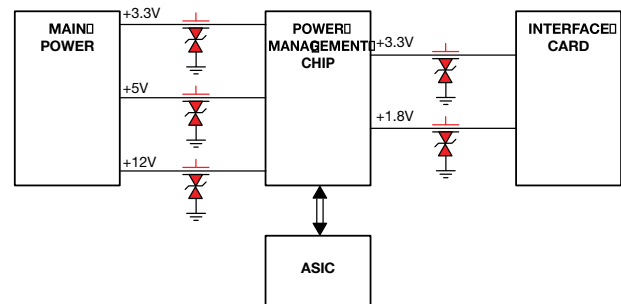

Fig. 4 – GaAs FET Protection

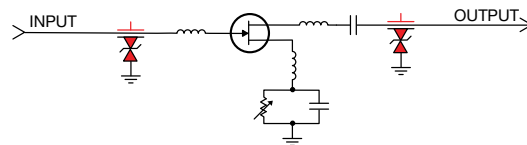
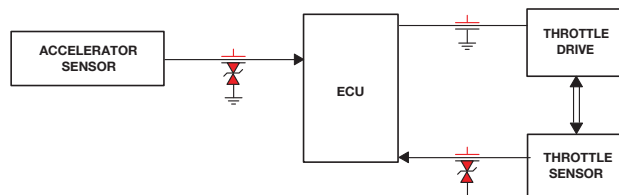

Fig. 5 – Automotive TransFeed - Throttle by Wire



## SPECIFICATION COMPARISON

MLVF 0805	PARAMETER		MLV 0805
5ph	Ls	typical	N/A
<600nh	Lp	typical	<1.5nh
<0.025Ω	Ron	typical	<0.1Ω
100pf to 2.5nf	C	typical	100pf to 5.5nf
see VI curves	Rv	typical	see VI curves
>0.25 x 1012Ω	Rp	typical	>1 x 1012Ω
<250ps	Typical turn on time Typical frequency response		<500ps

A comparison table showing typical element parameters and resulting performance features for MLV and MLVF is shown above.



The Important Information/Disclaimer is incorporated in the catalog where these specifications came from or available online at [www.avx.com/disclaimer/](http://www.avx.com/disclaimer/) by reference and should be reviewed in full before placing any order.



# SnPb Multilayer Varistors

## Multilayer Varistors with Tin/Lead Termination

### ELECTRICAL CHARACTERISTICS – TRANSGUARD<sup>®</sup>

AVX PN	V <sub>w</sub> (DC)	V <sub>w</sub> (AC)	V <sub>B</sub>	V <sub>C</sub>	I <sub>VC</sub>	I <sub>L</sub>	E <sub>T</sub>	I <sub>p</sub>	Cap	Freq
VCLD060305A150_B	5.6	4.0	8.5±20%	18	1	35	0.1	30	750	K
VCLD080505A150_B	5.6	4.0	8.5±20%	18	1	35	0.1	40	1100	K
VCLD080505C150_B	5.6	4.0	8.5±20%	18	1	35	0.3	120	3000	K
VCLD120605A150_B	5.6	4.0	8.5±20%	18	1	35	0.1	40	1200	K
VCLD120605D150_B	5.6	4.0	8.5±20%	18	1	35	0.4	150	3000	K
VCLD060309A200_B	9.0	6.4	12.7±15%	22	1	25	0.1	30	550	K
VCLD080509A200_B	9.0	6.4	12.7±15%	22	1	25	0.1	40	750	K
VCLD080512A250_B	12.0	8.5	16.0±15%	27	1	25	0.1	40	525	K
VCLD060314A300_B	14.0	10.0	18.5±12%	32	1	15	0.1	30	350	K
VCLD080514A300_B	14.0	10.0	18.5±12%	32	1	15	0.1	40	325	K
VCLD080514C300_B	14.0	10.0	18.5±12%	32	1	15	0.3	120	900	K
VCLD120614A300_B	14.0	10.0	18.5±12%	32	1	15	0.1	40	600	K
VCLD120614D300_B	14.0	10.0	18.5±12%	32	1	15	0.4	150	1050	K
VCLD060318A400_B	18.0	13.0	25.5±10%	42	1	10	0.1	30	150	K
VCLD080518A400_B	18.0	13.0	25.5±10%	42	1	10	0.1	30	225	K
VCLD080518C400_B	18.0	13.0	25.5±10%	42	1	10	0.3	100	550	K
VCLD120618A400_B	18.0	13.0	25.5±10%	42	1	10	0.1	30	350	K
VCLD120618D400_B	18.0	13.0	25.5±10%	42	1	10	0.4	150	900	K
VCLD121018J390_B	18.0	13.0	25.5±10%	42	5	10	1.5	500	3100	K
VCLD060326A580_B	26.0	18.0	34.5±10%	60	1	10	0.1	30	155	K
VCLD080526A580_B	26.0	18.0	34.5±10%	60	1	10	0.1	30	120	K
VCLD080526C580_B	26.0	18.0	34.5±10%	60	1	10	0.3	100	250	K
VCLD120626D580_B	26.0	18.0	34.5±10%	60	1	10	0.4	120	500	K
VCLD120626F540_B	26.0	20.0	33.0±10%	54	1	15	0.7	200	600	K
VCLD121026H560_B	26.0	18.0	34.5±10%	60	5	10	1.2	300	2150	K
VCLD060330A650_B	30.0	21.0	41.0±10%	67	1	10	0.1	30	125	K
VCLD080530A650_B	30.0	21.0	41.0±10%	67	1	10	0.1	30	90	M
VCLD080530C650_B	30.0	21.0	41.0±10%	67	1	10	0.3	80	250	K
VCLD120630D650_B	30.0	21.0	41.0±10%	67	1	10	0.4	120	400	K
VCLD121030G620_B	30.0	21.0	41.0±10%	67	5	10	0.9	220	1750	K
VCLD121030H620_B	30.0	21.0	41.0±10%	67	5	10	1.2	280	1850	K
VCLD080531C650_B	31.0	25.0	39.0±10%	65	1	10	0.3	80	250	K
VCLD120631M650_B	31.0	25.0	39.0±10%	65	1	15	1.0	200	500	K
VCLD080538C770_B	38.0	30.0	47.0±10%	77	1	10	0.3	80	200	K
VCLD120638N770_B	38.0	30.0	47.0±10%	77	1	15	1.1	200	400	K
VCLD120642L800_B	42.0	32.0	51.0±10%	80	1	15	0.8	180	600	K
VCLD120645K900_B	45.0	35.0	56.0±10%	90	1	15	0.6	200	260	K
VCLD120648D101_B	48.0	34.0	62.0±10%	100	1	10	0.4	100	225	K
VCLD121048G101_B	48.0	34.0	62.0±10%	100	5	10	0.9	220	450	K
VCLD121048H101_B	48.0	34.0	62.0±10%	100	5	10	1.2	250	500	K
VCLD120656F111_B	56.0	40.0	68.0±10%	110	1	15	0.7	100	180	K
VCLD121060J121_B	60.0	42.0	76.0±10%	120	5	10	1.5	250	400	K
VCLD120665M131_B	65.0	50.0	82.0±10%	135	1	15	1.0	150	250	K
VCLD121085S151_B	85.0	60.0	100±10%	150	1	35	2.0	250	275	K

### ELECTRICAL CHARACTERISTICS – STATICGUARD

AVX PN	V <sub>w</sub> (DC)	V <sub>w</sub> (AC)	V <sub>B</sub>	V <sub>C</sub>	I <sub>VC</sub>	I <sub>L</sub>	E <sub>T</sub>	I <sub>p</sub>	Cap	Case
VCLD06LC18X500_B	≤18	≤14	25-40	50	1	10	0.05	30	50M	0603
VCLD08LC18A500_B	≤18	≤14	25-45	50	1	10	0.1	30	80M	0805
VCLD12LC18A500_B	≤18	≤14	25-45	50	1	10	0.1	30	200K	1206

V<sub>w</sub>(DC) DC Working Voltage (V)  
V<sub>w</sub>(AC) AC Working Voltage (V)  
V<sub>B</sub> Min-Max Breakdown Voltage (V @ 1mA<sub>DC</sub>, 25°C)  
V<sub>C</sub> Clamping Voltage (V @ I<sub>VC</sub>)  
I<sub>VC</sub> Test Current for V<sub>C</sub> (A, 8x20µS)  
I<sub>L</sub> Maximum Leakage Current at the Working Voltage (µA, 25°C)

E<sub>T</sub> Transient Energy Rating (J, 10x1000µS)  
I<sub>p</sub> Peak Current Rating (A, 8x20µS)  
Cap Typical Capacitance (pF) @ frequency specified and 0.5 V<sub>RMS</sub>, 25°C, K = 1kHz, M = 1MHz

# Glass Encapsulated MLV SMD Varistor (VJ12, 20, 13, 14, 15, 32)

Transient Voltage Suppression, ESD Protection Devices & EMI Devices

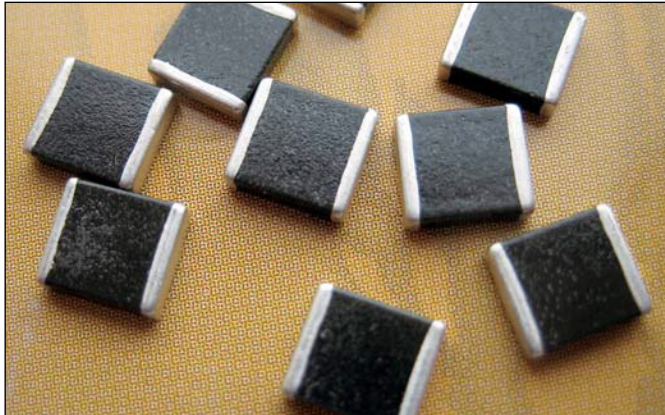

## GENERAL DESCRIPTION

AVX's Professional Multilayer Varistors include 3 series of glass coated products as listed below:

- Standard M0/MC/PC Series
- Telecom MT Series
- Automotive MA/PA/QA Series

The glass encapsulation process ensures high insulation resistance values after reflow soldering and excellent SMT compatibility. This protection ensures reliability and acidresistance against harsh environment like chlorite flux.

## TYPICAL APPLICATIONS

Mainly used to reduce transient over-voltages in a very wide range of electronic products. Some example applications are:

- 1) Telecom
- 2) Automotive
- 3) Consumer Electronics
- 4) Industrial Applications

## PHYSICAL CHARACTERISTICS

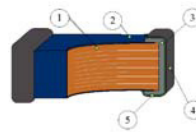

1. Zinc varistor
2. Glass lead-free encapsulation
3. Silver termination
4. Nickel barrier
5. Tin 100%

## PHYSICAL DIMENSIONS:

mm (inches)

Type	IEC Size	L	W	T	Land Length t
VJ12	0805	2.01±0.20 (0.079±0.008)	1.25±0.15 (0.049±0.006)	1.3 max. (0.051 max.)	0.15...0.55 (0.006...0.022)
VJ20	1206	3.20±0.20 (0.126±0.008)	1.60±0.20 (0.063±0.008)	1.7 max. (0.067 max.)	0.25...0.75 (0.010...0.030)
VJ13	1210	3.20±0.30 (0.126±0.012)	2.50±0.25 (0.098±0.010)	1.7 max. (0.067 max.)	0.25...0.75 (0.010...0.030)
VJ14	1812	4.50±0.30 (0.177±0.012)	3.20±0.30 (0.126±0.012)	2.0 max. (0.079 max.)	0.25...1.00 (0.010...0.039)
VJ15	2220	5.70±0.40 (0.224±0.016)	5.00±0.40 (0.197±0.016)	2.5max. (0.098 max.)	0.25...1.00 (0.010...0.039)
VJ32	3220	8.20±0.40 (0.323±0.016)	5.00±0.40 (0.197±0.016)	2.5 max. (0.098 max.)	0.35...1.30 (0.014...0.051)

## PART NUMBERING

**VJ**  
Varistor Termination  
VJ = Plated Ni/Sn100%  
VU = Plated Ni/SnPb  
VC = Hybrid AgPdPt

**14**  
Chip Size  
12 = 0805  
20 = 1206  
13 = 1210  
14 = 1812  
15 = 2220  
32 = 3220

**MT**  
Series Code  
M0,MC/QC = Industrial  
MT = Telecom  
MA/PA/QA = Automotive

**0950**  
Operating Voltage  
AC or DC

**K**  
1mA Voltage Tolerance  
K = ±10%

**BA**  
Packaging  
BA = Tape & Reel  
VJ12 = 4000 pcs/reel  
VJ20 = 3000 pcs/reel  
VJ13 = 2000 pcs/reel  
VJ14 = 1250 pcs/reel  
VJ15 = 1250 pcs/reel  
VJ32 = 1000 pcs/reel



# Glass Encapsulated MLV SMD Varistor (VJ12, 20, 13, 14, 15, 32)

## Automotive MLV Range – MA, PA and QA Series



### AUTOMOTIVE SERIES – VJ12, 20, 13, 14, 15, 32 MA AND PA SERIES

#### FEATURES

- Well suited to protect against automotive related transients
- Response time <1ns
- Load Dump capability 1J to 50J according to ISO standard DP7637 pulse 5
- Jump start capability
- Complying to AEC-Q 200
- VJ: Nickel and Tin (100%) plated Termination suitable for lead free soldering
- VC: PdPtAg termination for hybrid assembly without glass coating
- RoHS Compliant, IMDS Registration upon request

#### GENERAL CHARACTERISTICS

Storage Temperature: -55°C to +150°C  
 Operating Temperature: -55°C to +125°C\*  
 \* 150°C upon request  
 Available in case size 0805 to 3220  
 Working voltage from 16Vdc to 85Vdc

#### APPLICATIONS

- Protection of various semiconductor elements from overvoltage.
- Absorption of switching surge and electrostatic surge for relays and motors.
- Protection of electronic equipment for automobiles from induced lightning surge.

#### PART NUMBERS

	Case Size EIA	Working Voltage		Breakdown Voltage at 1mA			Vclamp (8x20µs)		Max. Peak current (8x20µs)	Max. leakage current at Vdc	Energy (10x 1000µs)	Energy Load-Dump (x10**)	Jump Start (5mn)	Mean Power Dissipation	Typical Cap 1KHz/5Vrms	T max.
		V <sub>rms</sub>	V <sub>dc</sub>	min	Nom	max	V <sub>p</sub>	I <sub>p</sub> (A)								
12-16 V Power Supply																
*VJ12PA0160K--	0805	14	16	22	24.5	27	40	1	120	15	0.3	1	24.5	0.005	500	1.3
VJ20MA0160K--	1206	14	16	22	24.5	27	40	1	200	15	0.6	1.5	24.5	0.008	800	1.7
VJ20PA0160K--	1206	14	16	22	24.5	27	40	1	300	15	1.1	2	24.5	0.008	1 100	1.7
VJ13MA0160K--	1210	14	16	22	24.5	27	40	2.5	400	15	1.6	3	24.5	0.010	1 800	1.7
VJ13PA0160K--	1210	14	16	22	24.5	27	40	2.5	500	15	2	5	24.5	0.010	2 300	1.7
VJ14MA0160K--	1812	14	16	22	24.5	27	40	5	800	15	2.4	6	24.5	0.015	5 400	2.0
VJ14PA0160K--	1812	14	16	22	24.5	27	40	5	1000	15	2.9	10	24.5	0.015	6 200	2.0
VJ15MA0160K--	2220	14	16	22	24.5	27	40	10	1200	15	5.8	12	24.5	0.030	11 000	2.0
VJ15PA0160K--	2220	14	16	22	24.5	27	40	10	1500	15	7.2	25	24.5	0.030	16 000	2.0
VJ15QA0160K--	2220	14	16	22	24.5	27	40	10	2000	15	7.5	35	24.5	0.030	25 000	2.0
VJ32PA0160K--	3220	14	16	22	24.5	27	40	10	3000	15	13.8	50	24.5	0.040	30 000	2.5
12-22 V Power Supply																
VJ20PA0220K--	1206	17	22	27	30	33	49	1	250	15	1	2	26	0.008	1 000	1.7
VJ13PA0220K--	1210	17	22	27	30	33	49	2.5	400	15	1.7	5	26	0.010	2 000	1.7
VJ14PA0220K--	1812	17	22	27	30	33	49	5	700	15	2.5	10	26	0.015	6 000	2.0
VJ15PA0220K--	2220	17	22	27	30	33	49	10	1500	15	6.8	25	26	0.030	15 000	2.0
VJ32PA0220K--	3220	17	22	27	30	33	49	10	3000	15	13	50	26	0.040	25 000	2.5
12-26 V Power Supply																
VJ20PA0260K--	1206	23	26	31.5	35	38.5	57	1	200	15	1	2	30	0.008	600	1.7
VJ13PA0260K--	1210	23	26	31.5	35	38.5	57	2.5	300	15	1.7	5	30	0.010	1 200	1.7
VJ14PA0260K--	1812	23	26	31.5	35	38.5	57	5	600	15	2.5	10	30	0.015	3 000	2.0
VJ15PA0260K--	2220	23	26	31.5	35	38.5	57	10	1500	15	6.8	25	30	0.030	7 000	2.0
VJ32PA0260K--	3220	23	26	31.5	35	38.5	57	10	3000	15	13	50	30	0.040	15 000	2.5
24-34 V Power Supply																
VJ20PA0340K--	1206	30	34	42.3	47	51.7	77	1	200	15	1.5	1.5	47	0.008	300	1.7
VJ13PA0340K--	1210	30	34	42.3	47	51.7	77	2.5	350	15	3.5	3	47	0.010	650	1.7
VJ14PA0340K--	1812	30	34	42.3	47	51.7	77	5	600	15	5	6	47	0.015	1 800	2.0
VJ15MA0340K--	2220	30	34	42.3	47	51.7	77	10	1200	15	10	12	47	0.030	4 000	2.0
VJ15PA0340K--	2220	30	34	42.3	47	51.7	77	10	1500	15	12	25	47	0.030	7 000	2.0
VJ32PA0340K--	3220	30	34	42.3	47	51.7	77	10	3000	15	13	50	47	0.040	10 000	2.5
24-42 V Power Supply																
*VJ20PA0420K--	1206	37	42	50.4	56	61.6	91	1	150	15	1.5	1.5	47	0.008	140	1.7
*VJ13PA0420K--	1210	37	42	50.4	56	61.6	91	2.5	250	15	3.5	3	47	0.010	300	1.7
*VJ14PA0420K--	1812	37	42	50.4	56	61.6	91	5	500	15	5	6	47	0.015	800	2.0
*VJ15PA0420K--	2220	37	42	50.4	56	61.6	91	10	1500	15	12	12	47	0.030	1 800	2.0
*VJ32PA0420K--	3220	37	42	50.4	56	61.6	91	10	3000	15	13	50	47	0.040	2 800	2.5

\* under development

\*\* time interval between pulses: 60s min.

VC with hybrid solderable termination same electrical characteristics

Other voltage or energy values available upon request



The Important Information/Disclaimer is incorporated in the catalog where these specifications came from or available online at [www.avx.com/disclaimer/](http://www.avx.com/disclaimer/) by reference and should be reviewed in full before placing any order.



# Glass Encapsulated MLV SMD Varistor (VJ12, 20, 13, 14, 15, 32) Automotive MLV Range – MA, PA and QA Series



	Case Size EIA	Working Voltage		Breakdown Voltage at 1mA			Vclamp (8x20µs)		Max. Peak current (8x20µs) Amp.	Max. leakage current at Vdc µA	Energy (10x 1000µs) J	Energy Load-Dump (x10**) J	Jump Start (5mn) max. V	Mean Power Dissipation W	Typical Cap 1KHz/.5Vrms pF	T max. mm
		V <sub>rms</sub>	V <sub>dc</sub>	min	Nom	max	V <sub>p</sub>	I <sub>p</sub> (A)								
24-65 V Power Supply																
*VJ20MA0650K--	1206	50	65	76.5	85	93.5	135	1	150	15	1.5	1.5	70	0.008	200	1.7
*VJ13MA0650K--	1210	50	65	76.5	85	93.5	135	2.5	250	15	3.5	3	70	0.010	200	1.7
*VJ14MA0650K--	1812	50	65	76.5	85	93.5	135	5	500	15	5	6	70	0.015	400	2.0
*VJ15MA0650K--	2220	50	65	76.5	85	93.5	135	10	1000	15	12	12	70	0.030	800	2.0
*VJ32MA0650K--	3220	50	65	76.5	85	93.5	135	10	1500	15	13	50	70	0.040	3500	2.5
24-85 V Power Supply																
*VJ20MA0850K--	1206	60	85	99	110	121	165	1	120	15	1.5	1.5	90	0.008	120	1.7
*VJ13MA0850K--	1210	60	85	99	110	121	165	2.5	200	15	3.5	3	90	0.010	200	1.7
*VJ14MA0850K--	1812	60	85	99	110	121	165	5	500	15	5	6	90	0.015	400	2.0
*VJ15MA0850K--	2220	60	85	99	110	121	165	10	1000	15	12	12	90	0.030	800	2.0
*VJ32MA0850K--	3220	60	85	99	110	121	165	10	1500	15	13	50	90	0.040	2500	2.5

\* under development

\*\* time interval between pulses: 60s min.

VC with hybrid solderable termination same electrical characteristics

Other voltage or energy values available upon request

## TEMPERATURE CHARACTERISTICS

For Current, Energy and Power

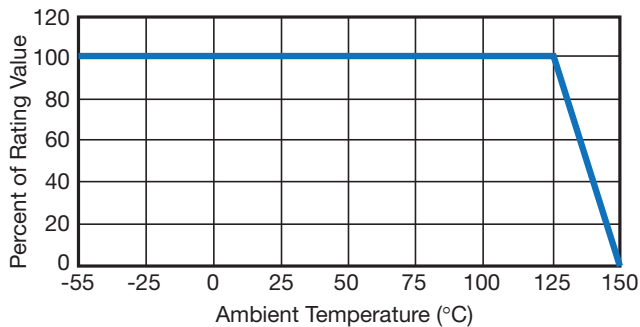

## IMPEDANCE CHARACTERISTICS

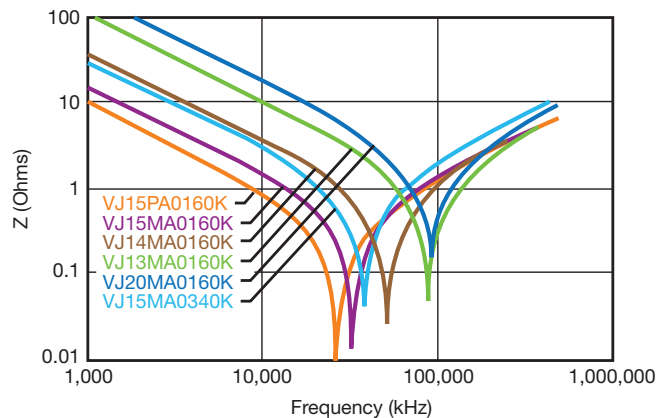

# Glass Encapsulated MLV SMD Varistor (VJ12, 20, 13, 14, 15, 32)

Automotive MLV Range – MA and PA Series



## AUTOMOTIVE SERIES – VJ12, 20, 13, 14, 15, 32 MA AND PA SERIES

### V / I CHARACTERISTICS

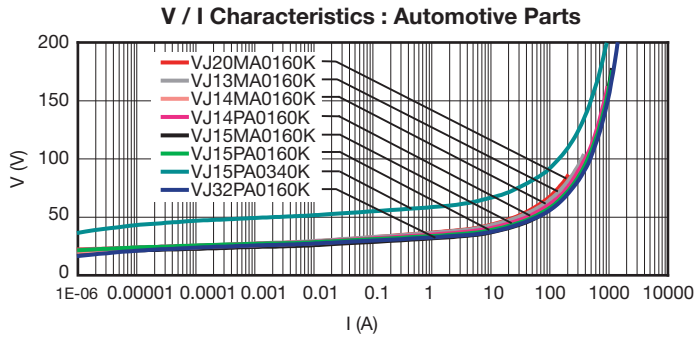

### PULSE RATING

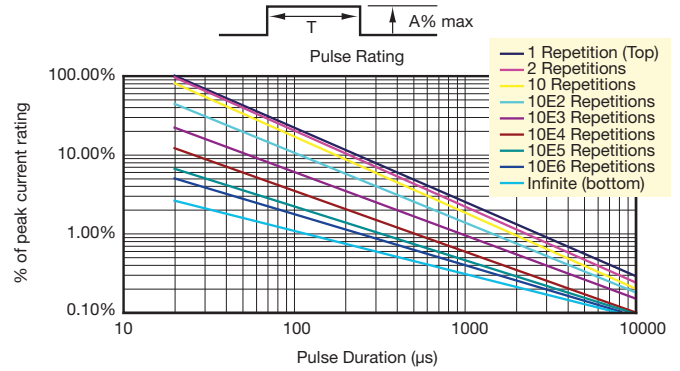

### TEMPERATURE DEPENDENCE OF V/I CHARACTERISTICS

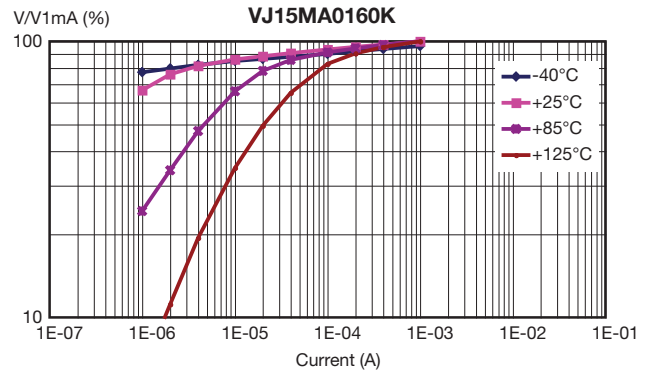
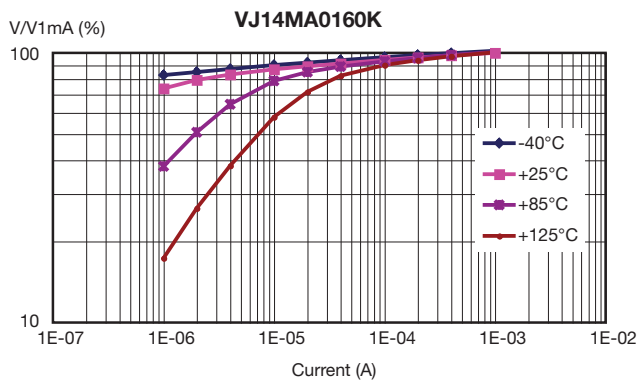
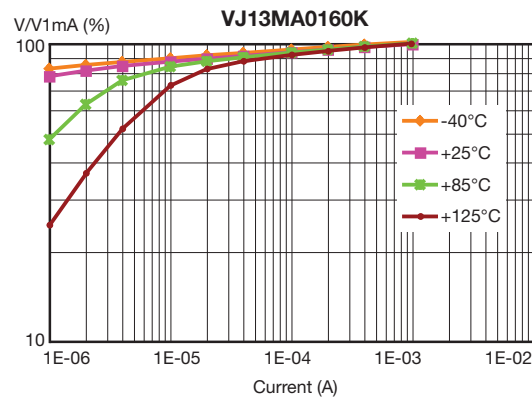
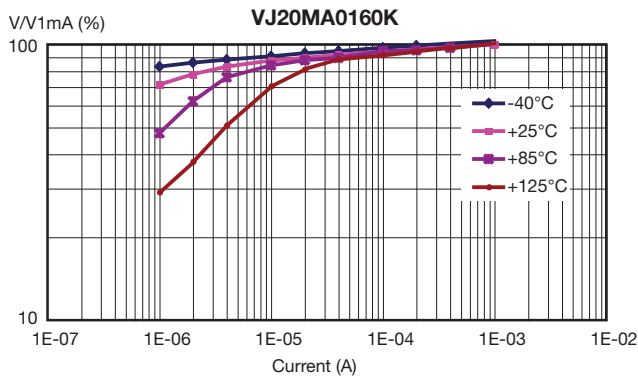



# Glass Encapsulated MLV SMD Varistor (VJ12, 20, 13, 14, 15, 32)

Automotive MLV Range – MA and PA Series



## AUTOMOTIVE SERIES – VJ12, 20, 13, 14, 15, 32 MA AND PA SERIES

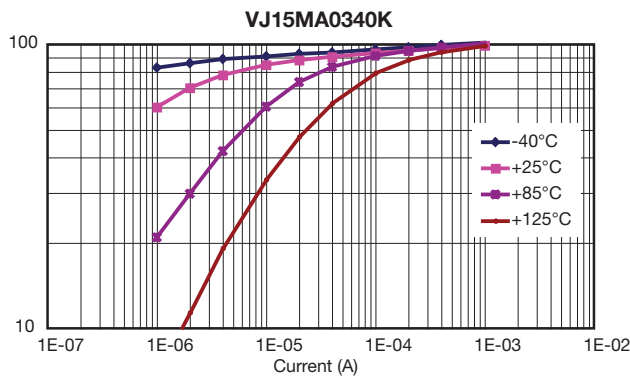
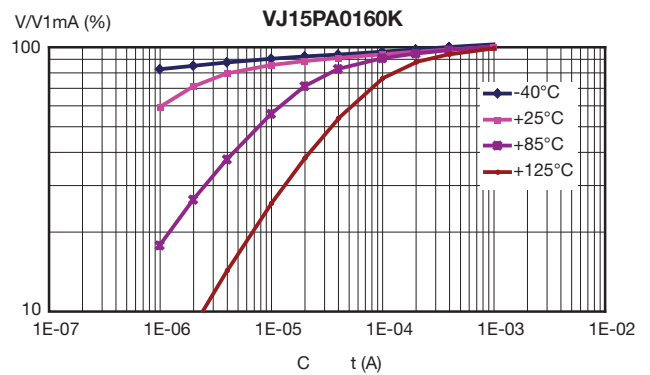
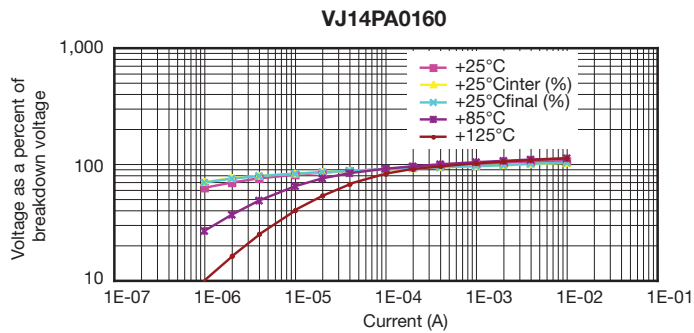

## PULSE DEGRADATION

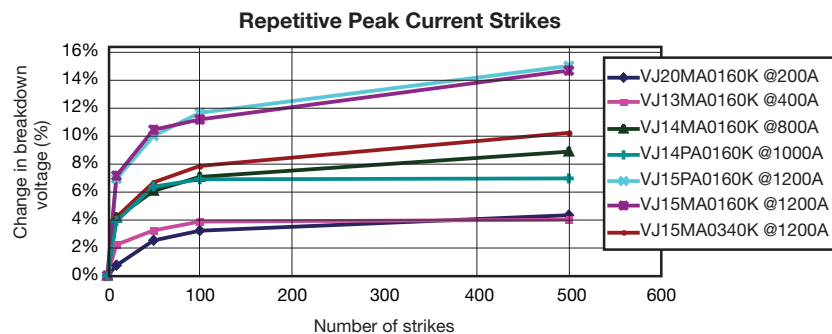

# Glass Encapsulated MLV SMD Varistor (VJ12, 20, 13, 14, 15, 32)

Automotive MLV Range – MA and PA Series



## AUTOMOTIVE SERIES – VJ12, 20, 13, 14, 15, 32 MA AND PA SERIES

### AUTOMOTIVE LOAD DUMP TEST

(According to ISO DP7637/2 Pulse 5)

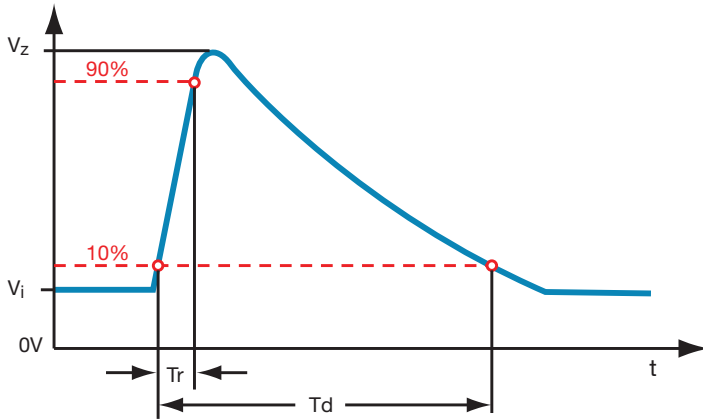

When using the test method indicated below, the amount of Energy dissipated by the varistor must not exceed the Load Dump Energy value specified in the product table.

Voltage Pulse applied to the varistor:

#### 12V Network

Vi = 13.5V  
Td = 100 to 350ms  
Ri = 2 Ohms (Internal Resistance)  
Vz - 70 to 200V  
Number of Pulses = 10 Pulses  
Other Load Dump Simulations can be achieved

#### 24V Network

Vi = 27V  
Td = 100 to 350ms  
Ri = 2 Ohms (Internal Resistance)  
Vz - 70 to 200V  
Number of Pulses = 10 Pulses

#### Pulse 5: Typical Vz max versus Pulse duration and Rs

VJ20PA0160K	0.5 Ω	1 Ω	2 Ω	4 Ω
50ms	33	34	39	49
100ms	31	31	34	43
200ms	27	28	33	43
400ms	28	30	34	42
VJ13PA0160K	0.5 Ω	1 Ω	2 Ω	4 Ω
50ms	44	48	57	75
100ms	36	39	46	60
200ms	33	33	39	50
400ms	28	28	34	46
VJ14PA0160K	0.5 Ω	1 Ω	2 Ω	4 Ω
50ms	60	68	85	125
100ms	46	52	62	77
200ms	37	41	50	63
400ms	32	35	43	54
VJ15PA0160K	0.5 Ω	1 Ω	2 Ω	4 Ω
50ms	80	116	145	188
100ms	61	80	104	140
200ms	47	60	78	100
400ms	39	47	58	74

VJ15QA0160K	0.5 Ω	1 Ω	2 Ω	4 Ω
100ms	65	78	91	117
200ms	54	60	73	92
400ms	44	51	60	75
VJ15MA0340K	0.5 Ω	1 Ω	2 Ω	4 Ω
100ms	66	78	91	117
200ms	55	60	73	92
400ms	49	53	60	75
VJ15PA0340K	0.5 Ω	1 Ω	2 Ω	4 Ω
100ms	80	90	108	134
200ms	60	67	80	106
400ms	58	62	69	85
VJ32PA0160K	0.5 Ω	1 Ω	2 Ω	4 Ω
100ms	102	120	175	200
200ms	72	85	120	158
400ms	53	62	78	105
VJ32PA0340K	0.5 Ω	1 Ω	2 Ω	4 Ω
100ms	90	105	133	170
200ms	70	79	98	132
400ms	62	70	83	106



The Important Information/Disclaimer is incorporated in the catalog where these specifications came from or available online at [www.avx.com/disclaimer/](http://www.avx.com/disclaimer/) by reference and should be reviewed in full before placing any order.

# Glass Encapsulated MLV SMD Varistor (VJ12, 20, 13, 14, 15, 32)

## Industrial MLV Range – M0 Series



### INDUSTRIAL MLV RANGE – VJ12, 20, 13, 14, 15 M0 SERIES

#### FEATURES

- Glass encapsulation device with very low leakage current under DC operating conditions
- Device available in case size 1206, 1210, 1812, 2220 (3220)
- Nickel and Tin (100%) plated Termination (Hybrid AgPdPt termination available upon request)
- Bi-Directional protection. Fast Turn-On Time.
- Excellent transient clamping characteristics up to 1200amps peak current
- Multi strike capability. Provide EMC Capacitance
- RoHS Compliant

#### GENERAL CHARACTERISTICS

Storage Temperature: -55°C to +150°C  
Operating Temperature: -55°C to +125°C

#### TYPICAL APPLICATIONS

Many uses to reduce transient over-voltage in the very wide range of electronic products in the Professional, Industrial and Consumer Applications.

Type	Case Size	Vrms	VDC	Breakdown Voltage	Max. Clamping Voltage	Maximum Leakage Current	Energy 10*1000µs	Max. Peak Current 8*20µs	Cap. Typical (1KHz/0.5V)	
		(V)	(V)	(V)	Vp (V)					Ip (A)
VJ20M00140K--	1206	14	18	22±10%	38	1	15	0.5	200	800
VJ13M00140K--	1210	14	18	22±10%	38	2.5	15	1.5	400	1800
VJ14M00140K--	1812	14	18	22±10%	38	5	15	2.3	800	4200
VJ15M00140K--	2220	14	18	22±10%	38	10	15	5.8	1200	9600
VJ20M00170K--	1206	17	22	27±10%	44	1	15	0.6	200	800
VJ13M00170K--	1210	17	22	27±10%	44	2.5	15	1.7	500	1600
VJ14M00170K--	1812	17	22	27±10%	44	5	15	2.7	800	3700
VJ15M00170K--	2220	17	22	27±10%	44	10	15	7.2	1200	8600
VJ20M00200K--	1206	20	26	33±10%	54	1	15	0.7	200	600
VJ13M00200K--	1210	20	26	33±10%	54	2.5	15	1.9	400	1200
VJ14M00200K--	1812	20	26	33±10%	54	5	15	3	800	3000
VJ15M00200K--	2220	20	26	33±10%	54	10	15	7.8	1200	6400
VJ20M00250K--	1206	25	31	39±10%	65	1	15	1	200	400
VJ13M00250K--	1210	25	31	39±10%	65	2.5	15	1.7	300	1100
VJ14M00250K--	1812	25	31	39±10%	65	5	15	3.7	800	2400
VJ15M00250K--	2220	25	31	39±10%	65	10	15	9.6	1200	5500
VJ20M00300K--	1206	30	38	47±10%	77	1	15	1.1	200	350
VJ13M00300K--	1210	30	38	47±10%	77	2.5	15	2	300	750
VJ14M00300K--	1812	30	38	47±10%	77	5	15	4.2	800	1900
VJ15M00300K--	2220	30	38	47±10%	77	10	15	12	1200	4200
VJ20M00350K--	1206	35	45	56±10%	90	1	15	0.6	200	260
VJ13M00350K--	1210	35	45	56±10%	90	2.5	15	1.5	300	530
VJ14M00350K--	1812	35	45	56±10%	90	5	15	4	500	1400
VJ15M00350K--	2220	35	45	56±10%	90	10	15	7.7	1000	2800
VJ20M00400K--	1206	40	56	68±10%	110	1	15	0.7	200	180
VJ13M00400K--	1210	40	56	68±10%	110	2.5	15	2.3	250	380
VJ14M00400K--	1812	40	56	68±10%	110	5	15	4.8	500	800
VJ15M00400K--	2220	40	56	68±10%	110	10	15	9	1000	2000
VJ20M00500K--	1206	50	65	82±10%	135	1	15	0.8	200	160
VJ13M00500K--	1210	50	65	82±10%	135	2.5	15	1.6	200	300
VJ14M00500K--	1812	50	65	82±10%	135	5	15	4.5	400	800
VJ15M00500K--	2220	50	65	82±10%	135	10	15	5.6	800	1400
VJ20M00600K--	1206	60	85	100±10%	165	1	15	0.9	120	100
VJ13M00600K--	1210	60	85	100±10%	165	2.5	15	2.0	200	210
VJ14M00600K--	1812	60	85	100±10%	165	5	15	5.8	400	600
VJ15M00600K--	2220	60	85	100±10%	165	10	15	6.8	800	1100



# Glass Encapsulated MLV SMD Varistor (VJ12, 20, 13, 14, 15, 32)

## Industrial MLV Range – M0 Series



### INDUSTRIAL MLV RANGE – VJ12, 20, 13, 14, 15 M0 SERIES V/I CHARACTERISTIC

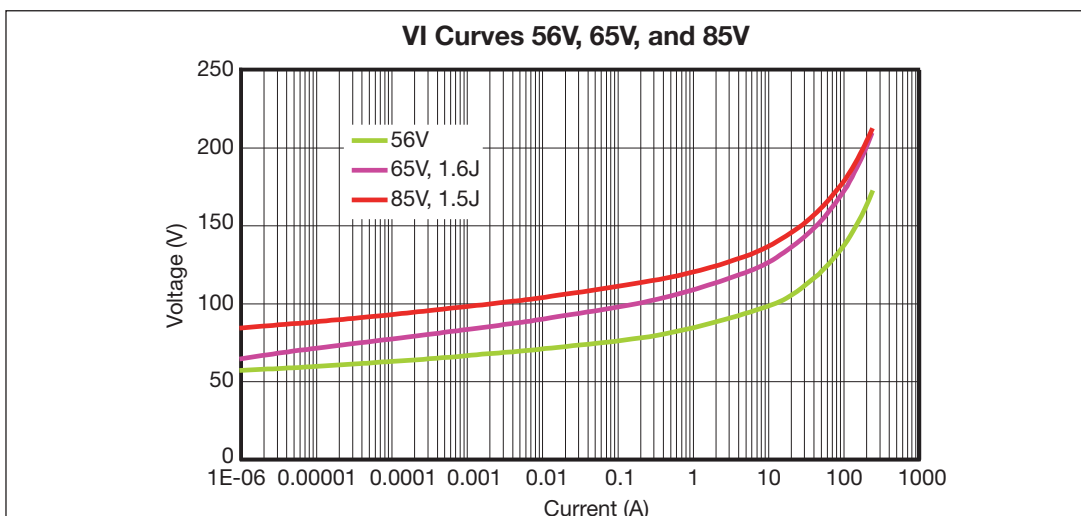
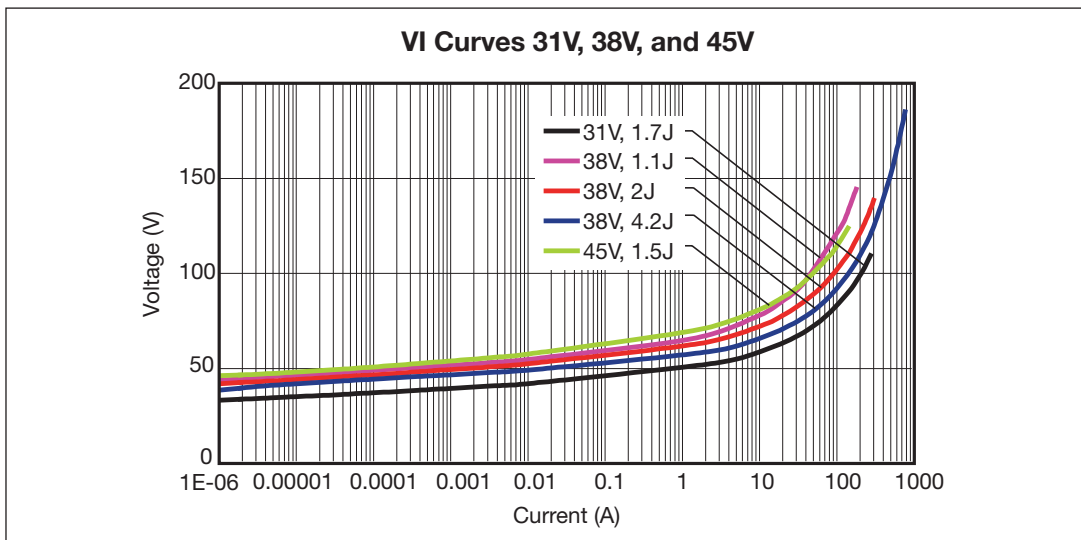
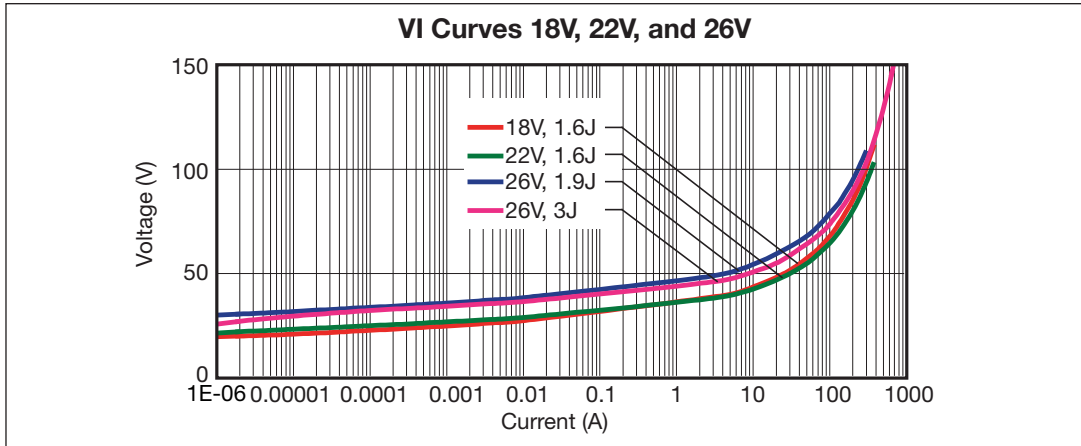

# Glass Encapsulated MLV SMD Varistor (VJ12, 20, 13, 14, 15, 32)

## Industrial MLV Range – MC/PC Series



### INDUSTRIAL MLV RANGE – VJ13 MC/PC SERIES

#### FEATURES

- Glass encapsulation device with very low leakage current under DC operating conditions
- Device available in 1210 case size
- Bi-Directional protection. Fast Turn-On Time.
- Nickel and Tin (100%) plated Termination (Hybrid AgPdPt termination available upon request)
- Excellent transient clamping characteristics up to 500amps peak current
- Multi strike capability. Provide EMC Capacitance
- RoHS Compliant

#### GENERAL CHARACTERISTICS

Storage Temperature: -55°C to +150°C  
 Operating Temperature: -55°C to +125°C  
 Working Voltage: 18Vdc to 60Vdc

#### TYPICAL APPLICATIONS

- Protection of various semiconductor elements from overvoltage
- Industrial equipment
- Consumer Electronics
- Plug-in cards, remote controls
- Home automation

Part Number	Working Voltage	Breakdown Voltage Voltage at 1mA			Vclamp (8x20µs)		max. peak current (8x20µs)	Energy (10x1000µs)	CAP (1KHz/.5Vrms)
	Vdc	min	Nom	max	Vp	Ip(A)	Amp.	J	pF
VJ13MC0180K--	18	21.6	24	26.5	45	10	500	1.5	2200
VJ13MC0260K--	26	29.7	33	36.3	62	10	300	1.2	1200
VJ13MC0300K--	30	35.1	39	42.9	73	10	220	0.9	1000
VJ13PC0300K--	30	35.1	39	42.9	73	10	280	1.2	1000
VJ13MC0480K--	48	54.5	60.5	66.5	110	10	220	0.9	530
VJ13PC0480K--	48	54.5	60.5	66.5	110	10	250	1.2	500
VJ13MC0600K--	60	67	75	83	126	10	250	1.5	400

VC with hybrid solderable termination same electrical characteristics  
 Other voltage values available upon request

# Glass Encapsulated MLV SMD Varistor (VJ12, 20, 13, 14, 15, 32)

## Telecom MLV Range – MT Series



### TELECOM MLV RANGE - VJ14 MT SERIES

#### FEATURES

- Effective alternative to leaded MOVs between 60 and 90 Vrsm
- High Energy Ratings up to 6 Joules with 1812 case size
- Nickel barrier or hybrid AgPdPt terminations
- Multiple Strike Capability
- Provide EMC Capacitance
- Specified in accordance to CCITT 10/1000µs Pulse test
- RoHS Compliant and IMDS Registration

#### CCITT 10X700MS TEST

A pulse of 10 x 700µs duration as specified by CCITT or IEC 61000-4-5 is often used to check the interference immunity of Telecom equipment. The curves show that the 60Vrms Varistor can reduce the interference of the equipment from 2KV to less than 200V.

#### TARGET APPLICATIONS

- Phone Lines, ADSL Lines, and other Telecom Circuits
- Consumer Products

#### GENERAL CHARACTERISTICS

Storage Temperature: -55°C to +125°C

Operating Temperature: -55°C to +125°C

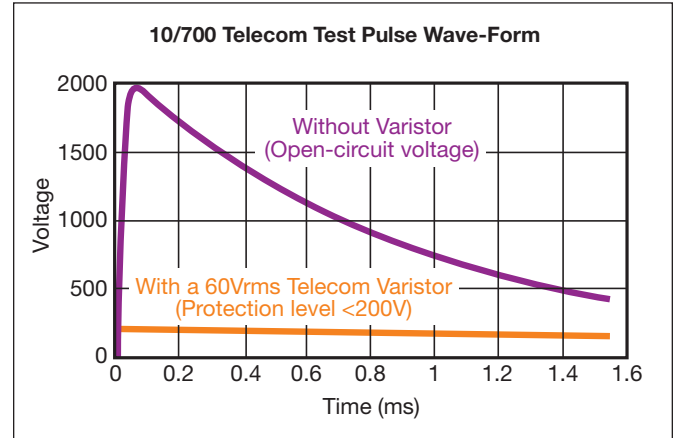
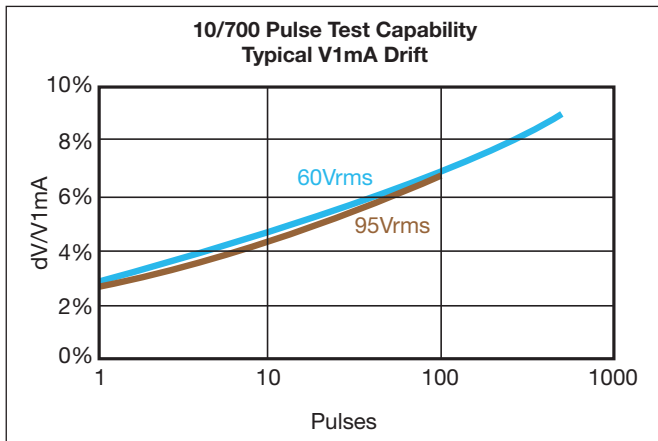

Ten pulses with a duration of 10x700µs applied at one minute intervals are specified for telecom equipment.

The curves show the V1mA drift when more than 10 pulses are applied.

#### PART NUMBERS

Part Number	Case Size	Operating Voltage		Breakdown Voltage	Max. Clamping Voltage		CCITT 10 Pulses 10*700µs	I max. 8*20µs	Energy 10*1000µs	Mean Power Dissipation	Typical Cap.
		Vac	Vdc		V(1mA)	V					
VJ14MT0600---	1812	60	85	107	200	45	45	400	6	0.015	400
VJ14MT0750---	1812	75	100	120	250	45	45	400	6	0.015	400
VJ14MT0950---	1812	95	125	150	270	45	45	250	5	0.015	280

Hybrid termination AgPdPt (VC Range) upon request



The Important Information/Disclaimer is incorporated in the catalog where these specifications came from or available online at [www.avx.com/disclaimer/](http://www.avx.com/disclaimer/) by reference and should be reviewed in full before placing any order.

# Glass Encapsulated MLV SMD Varistor (VJ32/VC32)

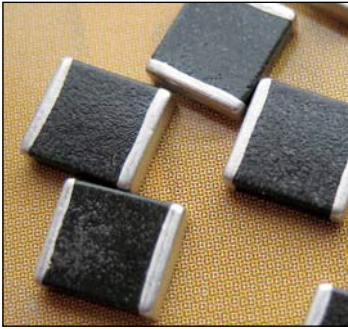

## GENERAL DESCRIPTION

The VJ32/VC32M0 Series offers the designer a surface mount solution with higher voltage ratings and transient energy ratings. This Multilayer Layer Surface Mount Varistor replaces the traditional radial-lead Varistors with reduced size and weight. The glass encapsulation ensures the high performances in voltage up to 300Vrms reliability and acid-resistance against harsh environment like chlorite soldering flux.

## APPLICATIONS

- MOV (Radial) Replacement
- Suppression of transient on line voltage
- Electric Meters
- Industrial Equipment
- Mains PSUs
- Telecommunications
- Consumer Electronics

## FEATURES

- Lead less surface mount chip 3220 Case Size
- Voltage Ratings from 175Vrms to 300 Vrms
- VJ32 with Ni barrier/100% Sn Termination (for lead free soldering applications)
- VC32 with hybrid PdPtAg Termination (not suitable for lead free soldering)
- Operating temperature from -55°C to +85°C
- RoHS Compliant



## PART NUMBERS

AVX Part Number	Case Size	Operating voltage		Breakdown Voltage Voltage at 1mA			Max. Clamping Voltage 8*20µs		Max. Leakage Current	Energy 10*1000µs	Max. Peak Current 8*20µs 1 Pulse	Cap. Typical (1KHz,0.5V)
		Vrms	Vdc	Min.	Average	Max.	V	A	µA	Joule	A	pF
VJ32M00140K--	3220	14	18	19.8	22	24.2	47	10	15	0.7	1500	15000
VJ32M00170K--	3220	17	22	24.3	27	29.7	57	10	15	0.9	1500	15000
VJ32M00200K--	3220	20	26	29.7	33	36.3	68	10	15	1.1	1500	15000
VJ32M00250K--	3220	25	31	35.1	39	42.9	79	10	15	1.2	1500	15000
VJ32M00300K--	3220	30	38	42.3	47	51.7	92	10	15	1.5	1500	15000
VJ32M00350K--	3220	35	45	50.4	56	61.6	107	10	15	1.8	1200	5000
VJ32M00400K--	3220	40	56	61.2	68	74.8	127	10	15	2.2	1200	5000
VJ32M00500K--	3220	50	66	73.8	82	90.2	135	10	15	2.5	1000	3500
VJ32M00600K--	3220	60	85	90.0	100	110	165	10	15	3	1000	2500
VJ32M00750K--	3220	75	102	108	120	132	200	10	15	3.5	600	2000
VJ32M00900K--	3220	95	127	135	150	165	250	10	15	6	600	1500
VJ32M01150K--	3220	115	153	162	180	198	295	10	15	6.5	300	350
VJ32M00131K--	3220	130	175	180	200	220	340	10	15	7	300	170
VJ32M00141K--	3220	140	180	198	220	242	360	10	15	7.5	300	140
VJ32M00151K--	3220	150	200	216	240	264	395	10	15	9	300	130
VJ32M01750K--	3220	175	225	243	270	297	455	10	15	9.5	300	120
VJ32M00231K--	3220	230	300	324	360	396	595	10	15	10	300	80
VJ32M00251K--	3220	250	330	351	390	429	650	10	15	11	300	75
VJ32M02750K--	3220	275	369	387	430	473	710	10	15	13	300	70
VJ32M00301K--	3220	300	385	423	470	517	775	10	15	15	300	65

VC32 Series with solderable hybrid termination. Glass encapsulation from 115Vrms to 300Vrms.  
Other voltage values available upon request

# Glass Encapsulated MLV SMD Varistor (VJ13, 14, 15, 20)

## Surface Mounting Guide



### SURFACE MOUNTING GUIDE (VJ13, 14, 15, 20, 32) APPLICATIONS NOTES

Recommended Reflow Profiles

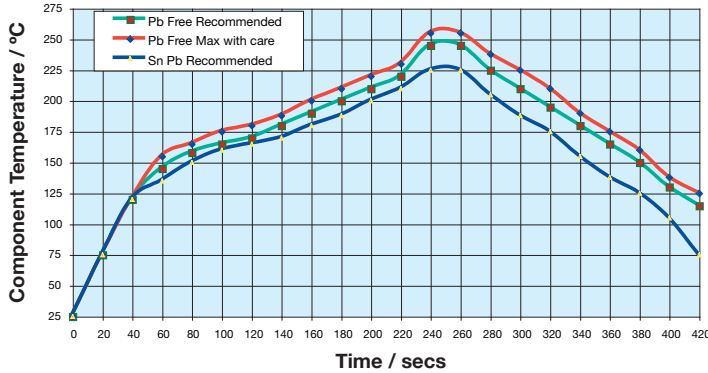

### RECOMMENDED SOLDERING PROFILES

VJ products are compatible with a wide range of soldering conditions consistent with good manufacturing practice for surface mount components. This includes Pb free reflow processes and peak temperatures up to 270°C. Recommended profiles for reflow and wave soldering are show below for reference.

VC products are recommended for lead soldering application or gluing techniques.

### VJ Products Lead-Free Reflow Profile

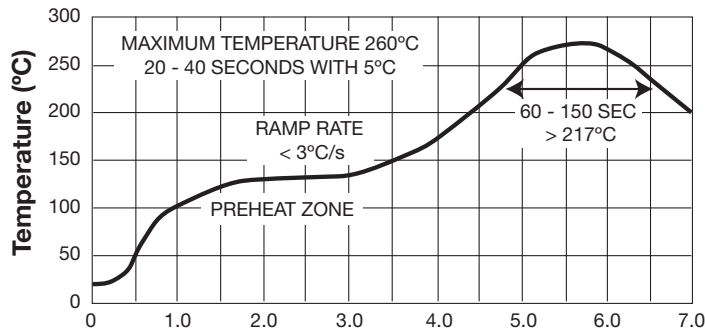

The visual standards used for evaluation of solder joints will need to be modified as lead free joints are not as bright as with tin-lead pastes and the fillet may not be as large.

Lead-free solder pastes do not allow the same self alignment as lead containing systems. Standard mounting pads are acceptable, but machine set up may need to be modified.

### RECOMMENDED SOLDER PAD LAYOUT

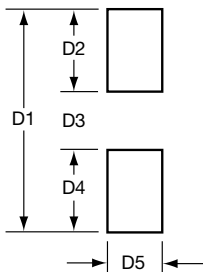

### REFLOW SOLDERING

Dimensions in mm (inches)

Case Size	D1	D2	D3	D4	D5
1206	4.00 (0.157)	1.00 (0.039)	2.00 (0.079)	1.00 (0.039)	1.06 (0.042)
1210	4.00 (0.157)	1.00 (0.039)	2.00 (0.079)	1.00 (0.039)	2.05 (0.081)
1812	5.60 (0.220)	1.00 (0.039)	3.60 (0.142)	1.00 (0.039)	3.00 (0.118)
2220	6.60 (0.260)	1.00 (0.039)	4.60 (0.181)	1.00 (0.039)	5.00 (0.197)
3220	10.21 (0.402)	2.21 (0.087)	5.79 (0.228)	2.21 (0.087)	5.50 (0.217)

### WAVE SOLDERING

Dimensions in mm (inches)

Case Size	D1	D2	D3	D4	D5
1206	5.00 (0.197)	1.50 (0.059)	2.00 (0.079)	1.50 (0.059)	1.06 (0.042)
1210	5.00 (0.197)	1.50 (0.059)	2.00 (0.079)	1.50 (0.059)	2.05 (0.081)
1812	6.60 (0.260)	1.50 (0.059)	3.60 (0.142)	1.50 (0.059)	3.00 (0.118)
2220	7.60 (0.299)	1.50 (0.059)	4.60 (0.181)	1.50 (0.059)	5.00 (0.197)
3220	11.21 (0.441)	1.50 (0.059)	5.79 (0.228)	1.50 (0.059)	5.50 (0.217)







# Application Guide

## Typical Circuits

### Requiring Protection

The following applications and schematic diagrams show where TransGuards® might be used to suppress various transient voltages:

- ASIC Reset & Vcc Protection
- Micro Controllers, Relays, DC Motors
- I/O Port Protection
- Keyboard Protection
- Modem Protection
- Sensor Protection
- Preamplifier Protection
- Audio Circuit Protection
- LCD Protection
- Optics Protection

**ASIC RESET & Vcc PROTECTION**

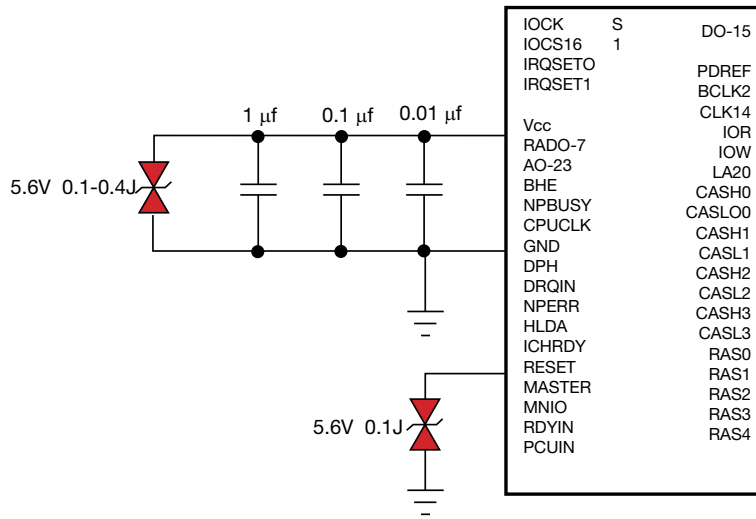

**MICRO CONTROLLERS RELAYS, DC MOTORS**

**TRANSQUARD® CHARACTERISTICS**

WORKING VOLTAGE ≥ RELAY OR MOTOR VOLTAGE

ENERGY RATING TYPICALLY > 0.3J

CAPACITANCE IS OF NO CONCERN

**CMOS RELAY DRIVER**

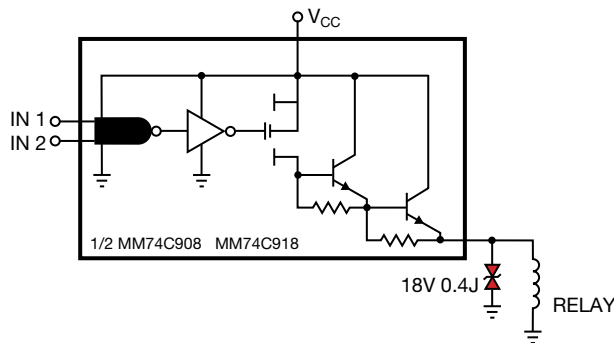

**LM319 RELAY DRIVER**

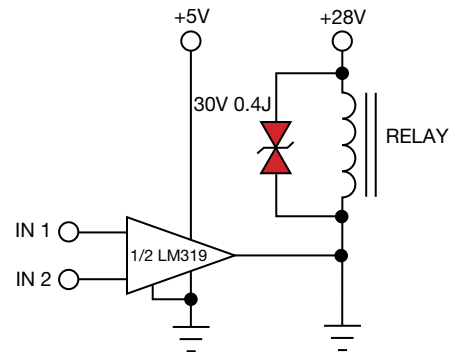

= TransGuard®

**I/O PORT PROTECTION**  
**TRANSGUARD® CHARACTERISTICS**

WORKING VOLTAGE TYPICALLY 14V - 18V  
 ENERGY RATING TYPICALLY 0.05J - 0.1J  
 CAPACITANCE SHOULD BE MINIMIZED

**SUB NOTEBOOK & PDA'S**

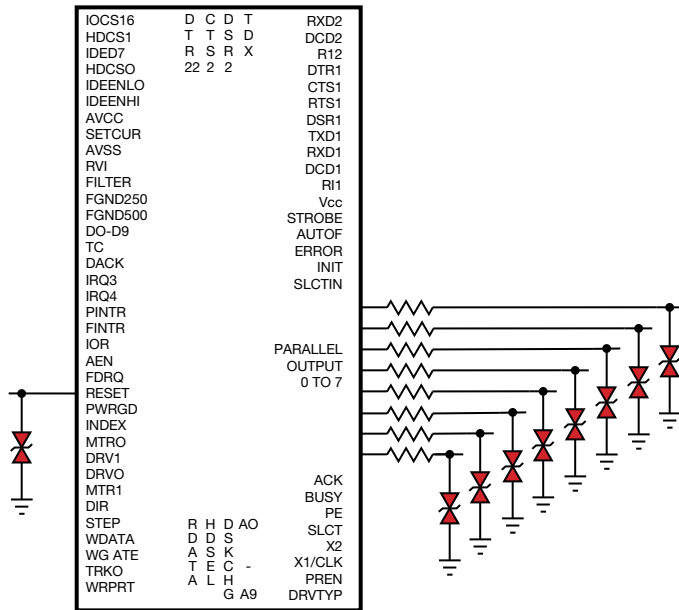

**NOTEBOOK & WORK STATION**

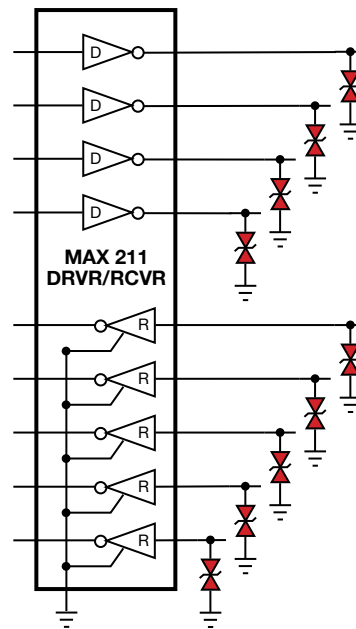

**KEYBOARD PROTECTION**  
**TRANSGUARD® CHARACTERISTICS**

WORKING VOLTAGE >5.6V  
 ENERGY RATING TYPICALLY <0.4J  
 CAPACITANCE PREFERRED TO BE MINIMUM

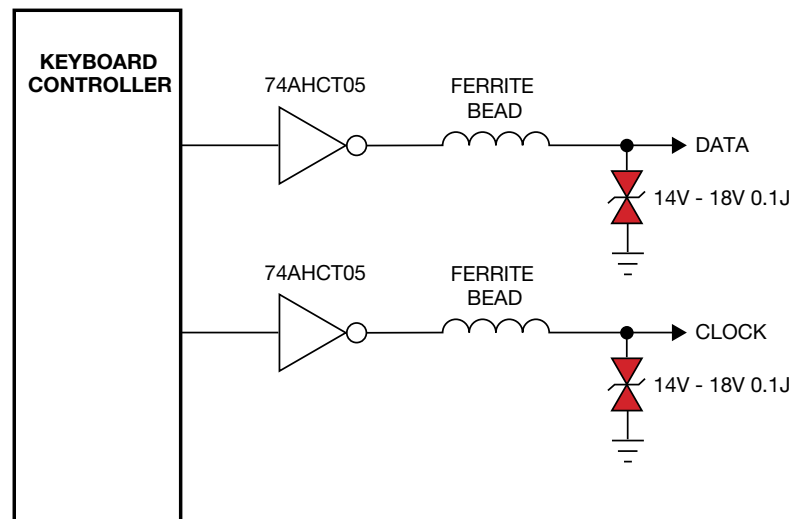

= TransGuard®

**MODEM PROTECTION**  
**TRANSGUARD® CHARACTERISTICS**

WORKING VOLTAGE <26V  
 ENERGY RATING ≥ 0.1J

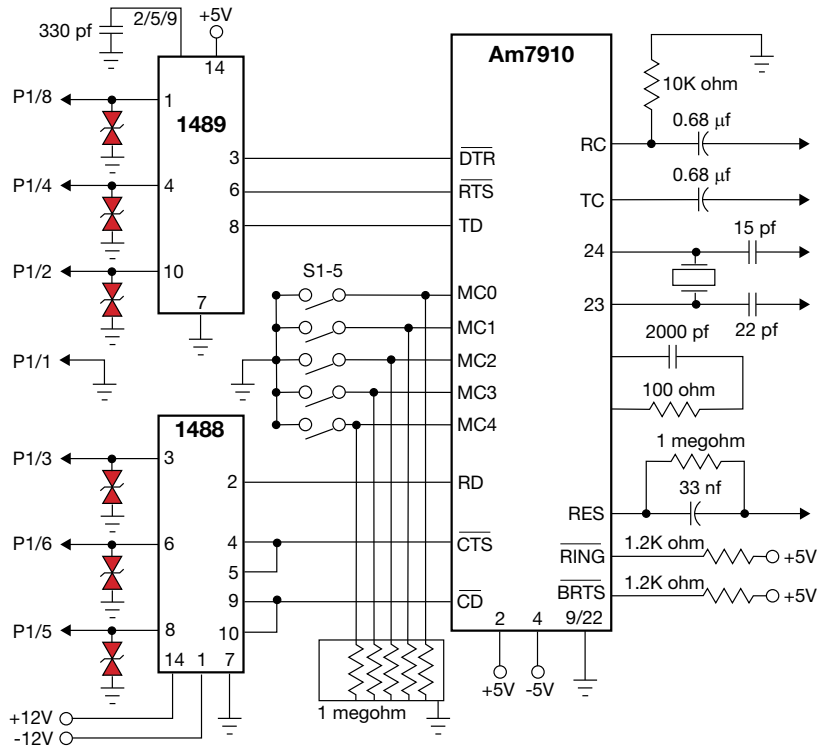

**SENSOR PROTECTION**  
**TRANSGUARD® CHARACTERISTICS**

WORKING VOLTAGE TYPICALLY >14V  
 ENERGY RATING > 0.4J  
 CAPACITANCE IS NO CONCERN

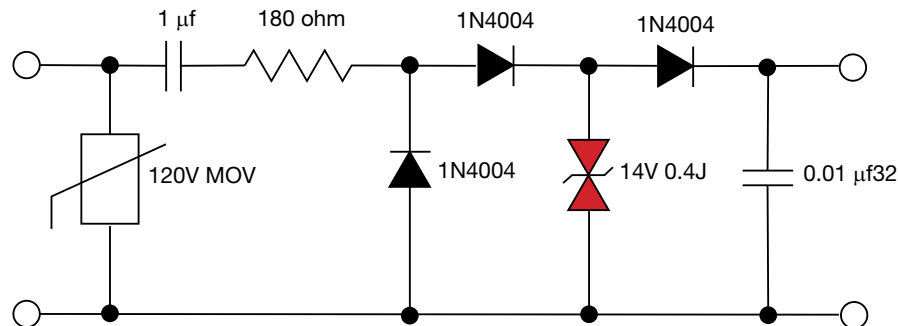

= TransGuard®

**ANTENNA AND PREAMPLIFIER PROTECTION**

**TRANSQUARD® CHARACTERISTICS**

WORKING VOLTAGE TYPICALLY 18V - 26V  
 ENERGY RATING 0.05J - 0.9J  
 CAPACITANCE OF CONCERN ON MANY DESIGNS

**PREAMPLIFIER PROTECTION**

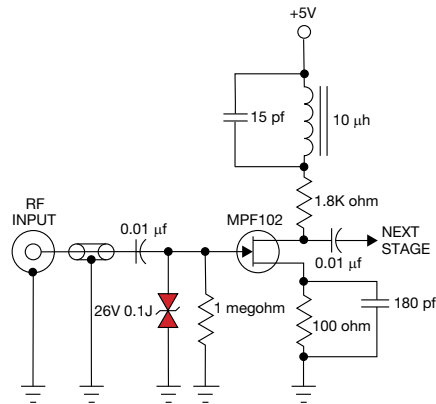

**AUDIO CIRCUIT PROTECTION**  
**TRANSQUARD® CHARACTERISTICS**

WORKING VOLTAGE TYPICALLY 14V - 18V  
 ENERGY RATING 0.1J

**PAGER AUDIO PROTECTION**

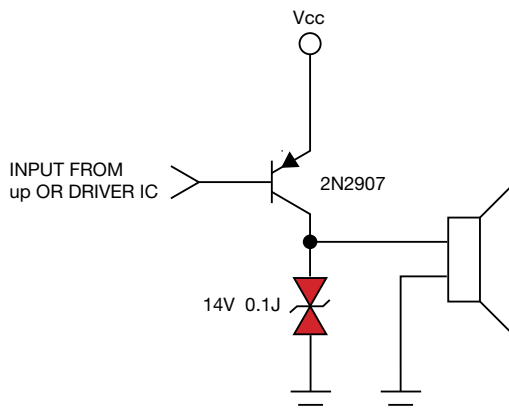

**NOTEBOOK, WORK STATION AUDIO PROTECTION**

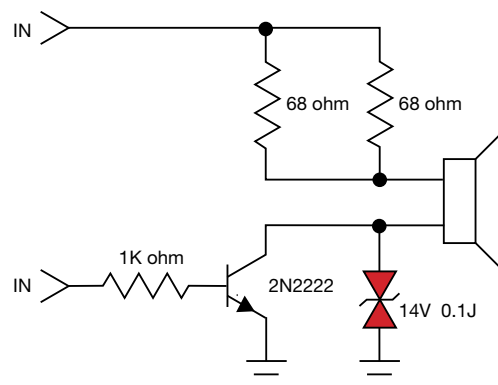

 = TransGuard®

**LCD PROTECTION**  
**TRANSGUARD® CHARACTERISTICS**

WORKING VOLTAGE < 5.6V  
 ENERGY RATING < 0.1J

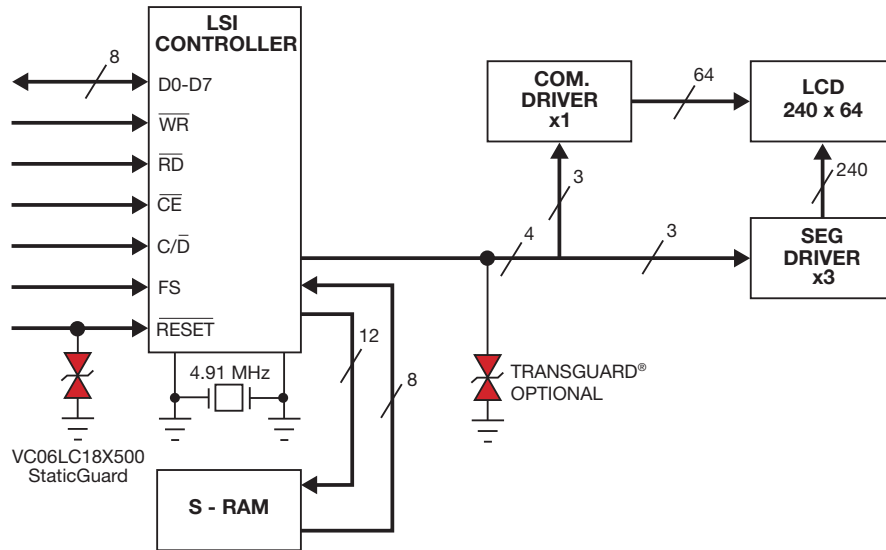

**OPTICS PROTECTION**  
**TRANSGUARD® CHARACTERISTICS**

WORKING VOLTAGE ≤ 18V  
 ENERGY RATING 0.1J  
 CAPACITANCE SHOULD BE MINIMIZED

**OPTO ISOLATER PROTECTION**

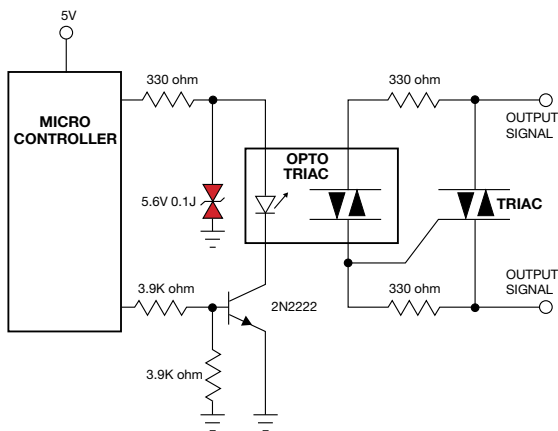

**LASER DIODE PROTECTION**

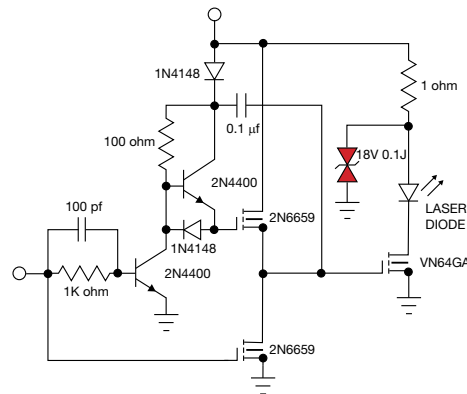

= TransGuard®

# General Applications (TransGuard®)

## AVX Multilayer Transient Voltage Protection

### Circuit Protection in Automotive Applications



### AUTOMOTIVE TRANSIENTS

Today's automobiles are using new technologies based on electronics systems connected by wide variety of networks to provide increased safety, convenience and comfort, to reduce emissions, increase fuel efficiency and more.

During the lifetime these systems are subjected to many overvoltage transient surges. To ensure safe and reliable function it is necessary to protect these sensitive systems against overvoltage surges.

### AUTOMOTIVE POWER RAIL TRANSIENTS

The transients on automotive power rails are usually medium to high energy transients and are caused by engine start such as Jump start (connecting other cars battery to jump start the engine), Load Dump (sudden load disconnect from alternator) or inductive switching (caused by DC motors on/off switching - e.g. window lifter, wipers, adaptive headlights). These transients are typically bi-directional.

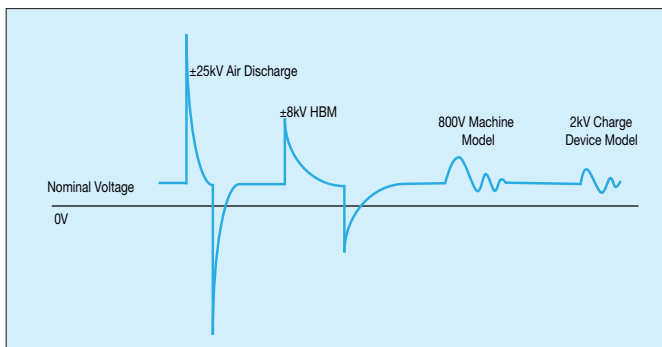

### AUTOMOTIVE DATA LINE TRANSIENTS

Data lines connecting the automotive systems need to be protected against various ESD pulses to ensure sensitive electronics protection. These transients are mainly caused by human interaction with the electronics systems (controls, buttons, ports) or by interaction between systems due to different charge build up. These transients are typically bi-directional and very fast.

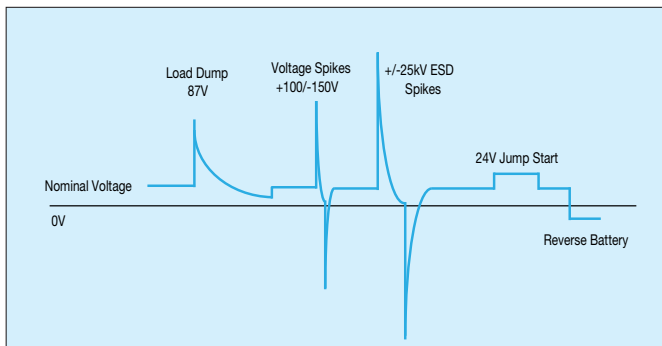

### AVX MULTILAYER VARISTORS

The EMC requirements of today's automotive electronics are a natural fit for the use of AVX MultiLayer Varistors (MLVs).

#### AVX AUTOMOTIVE VARISTORS ADVANTAGES

- AEC-Q200 qualified
- Bi-directional protection
- Compact footprint
- Very fast response - sub ns
- EMI/RFI filtering in the off state
- Multiple strikes capability
- No derating over operating temperature range (-55°C to +125°C, 150°C available)
- RoHS compliant
- Optional hybrid termination (Pd/Ag) available

AVX Automotive Series Varistors provide reliable protection against automotive related transients - such as Load Dump, Jump Start and ESD to protect the growing number of electronics systems used in automotive applications. Transient examples:

- Load dump (ISO 7637-2-5)
- Jump Start
- ISO 7637 Pulse 1-3
- IEC 61000-4-2, etc.
- AEC-Q200-002
- ISO 10605
- ISO 16750-2
- CI-220
- CI-260

The parts offer fast turn on time, bi-directional protection, excellent multiple strikes capability and in addition also EMI/RFI filtering in the off-state that can improve overall system EMC performance.

High power MLV designs have been revised and miniaturized to allow efficient protection of today's most widely used communication bus designs.

When used in communication bus designs, MLVs can save approximately 90% of the board area involved with diode/EMC cap solutions. In addition, MLVs offer a FIT rate <0.1, an ability to be used at temperatures up to 150°C and a fast turn on time.

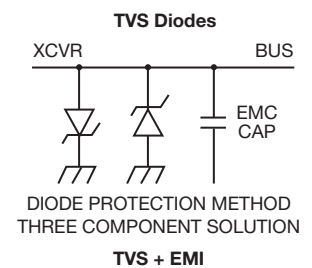
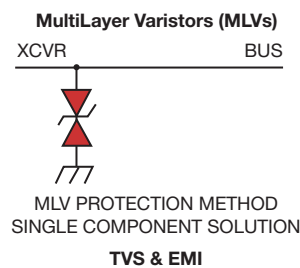

# Automotive Application (TransGuard®)

## AVX Multilayer Transient Voltage Protection Circuit Protection in Automotive Applications



MLVs have traditionally been used in inductively generated automotive transient suppression applications such as motors, relays and latches. MLVs offer a large inrush current capability in a small package, high-energy transient suppression and a broad and definable off state bulk EMC capacitance. These, coupled with an extremely low FIT rate and excellent process capability makes MLVs a common device in today's intermediate to high power automotive circuit protection.

### AUTOMOTIVE COMMUNICATION BUS

AVX varistors are ideal choice for automotive circuit protection thanks to wide range of automotive qualified parts covering wide range of applications from low capacitance components for high speed data lines/RF circuits up to high energy varistors for load dump and jump start requirements on power lines or low speed data lines such as LIN Bus. AVX also offers automotive varistors for targeted and enhanced EMI filtering that help to improve overall EMC system performance.

Automotive electronic systems are connected by various network systems depending on the data speed requirements. Most common networks include:

### LIN (LOCAL INTERCONNECT NETWORK)

LIN Bus operates at slower data speeds up to 20kbps and provides reliable low cost automotive networking. Typical applications are e.g. window lifter, door lock, seat controls, mirror controls, wipers, rain sensors etc.

### CAN (CONTROLLER AREA NETWORK)

CAN Bus is a vehicle bus standard designed to allow microcontrollers and devices to communicate with each other within a vehicle without a host computer. CAN Bus supports data speeds up to 1Mbps. Typical applications are ECU connection to transmission, door locks, adaptive headlights, climate control, etc.

### MOST (MEDIA ORIENTED SYSTEMS TRANSPORT)

MOST is standard for high-bandwidth automotive multimedia networking. This network provides excellent Quality of Service and seamless connectivity for audio/video streaming through variety of multimedia interfaces such as DVD player, head set, voice control.

### FLEXRAY

FlexRay is an automotive network communications protocol to govern on-board automotive computing. It is designed to be faster and more reliable than CAN and TTP intended for drive-by-wire applications.

Example of suitable AVX series based on data speed and line type is shown below:

SERIES	BUS	DATA SPEED	
Sub pF AntennaGuard Automotive Series	HDMI 1394a	3.2 Gbps 400 Mbps	High Speed
AG/Sub pF AG Automotive Series, Miniature AC	MOST TTP	45 Mbps 25 Mbps	
FlexRay	FlexRay	10 Mbps	Data
CAN, FlexRay, AG Series	TTCAN CAN	1 Mbps	
TransGuard® Automotive Series, Safe-by-Wire StaticGuard Automotive Series, Radial Varistor	LIN	1 Mbps - 50 Kbps 150 Kbps <20 Kbps	Low Speed
TransGuard® Automotive Series, StaticGuard Automotive Series, Radial Varistor, Miniature MAC, TransFeed Automotive Series	ALL		Power Line
TransFeed Automotive Series, Controlled Capacitance	10-100 Mbps		Cutoff Frequency



# Automotive Application (TransGuard®)

## AVX Multilayer Transient Voltage Protection Circuit Protection in Automotive Applications



### LIN BUS

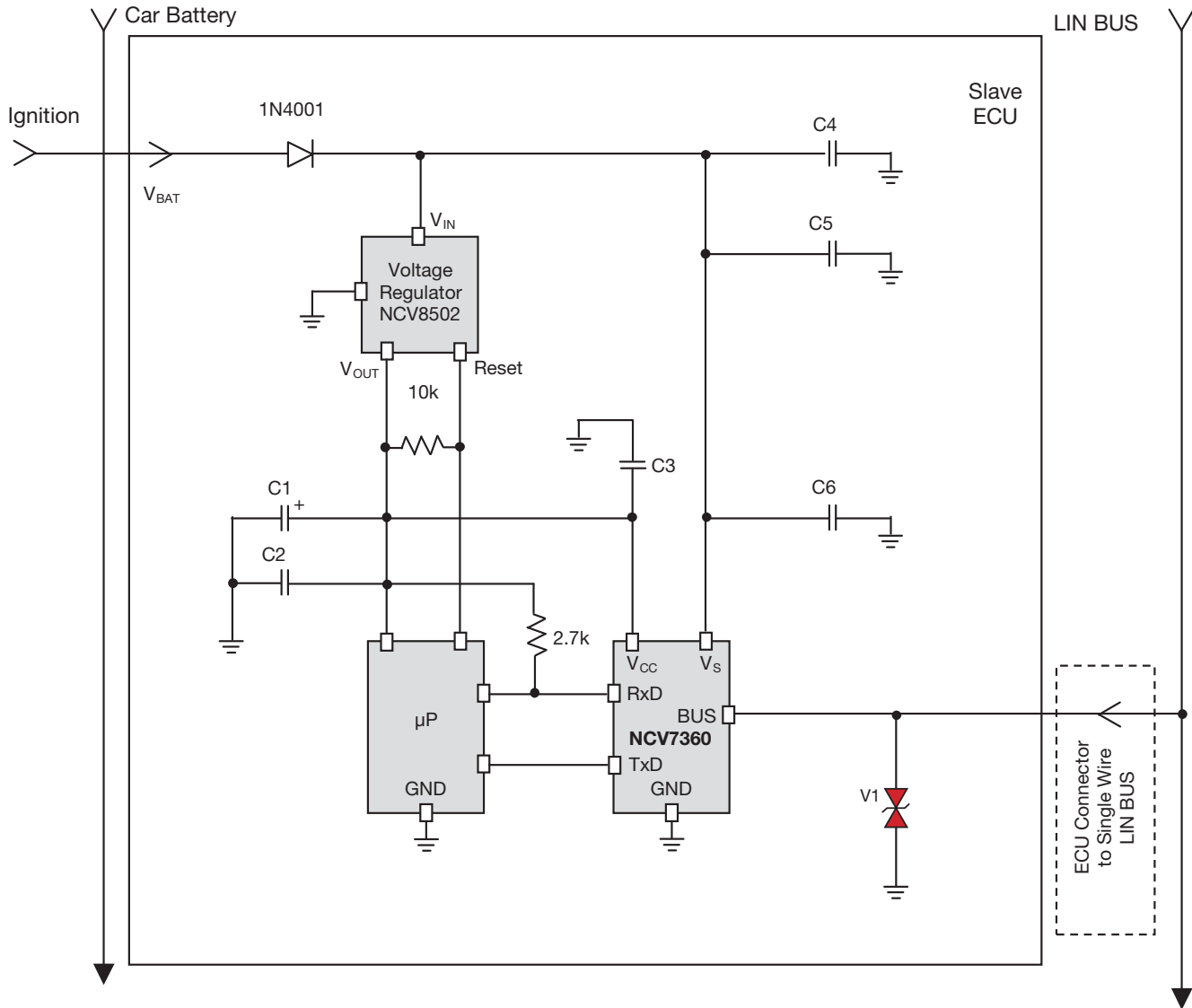

Component	Product	AVX Part number	Specification
V1	Multilayer Varistor	VCAS080518C400RP	0805, 18Vdc, 0.3J, 120A, 550pF typ

# Automotive Application (TransGuard®)

## AVX Multilayer Transient Voltage Protection Circuit Protection in Automotive Applications



### CAN BUS

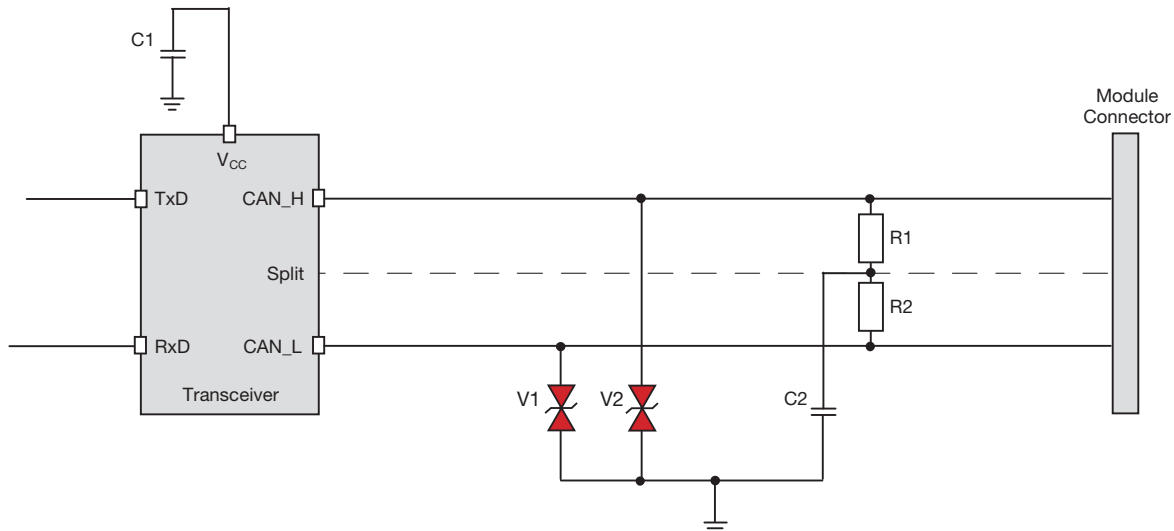

Component	Product	AVX Part number	Specification
V1, V2	Multilayer Varistor	CAN0001RP	0603, 18Vdc, 0.015J, 4A, 22pF max
(V1+V2)	Multilayer Varistor	CAN0002RP	0405 Dual Array, 0.015J, 4A, 22pF max

### CAN BUS

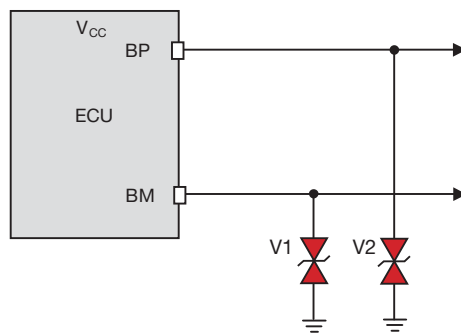

Component	Product	AVX Part number	Specification
V1, V2	Multilayer Varistor	FLX0005WP	0402, 18Vdc, 0.02J, 4A, 17pF max

# Automotive Application (TransGuard®)

## AVX Multilayer Transient Voltage Protection Circuit Protection in Automotive Applications



### ELECTRIC POWER STEERING

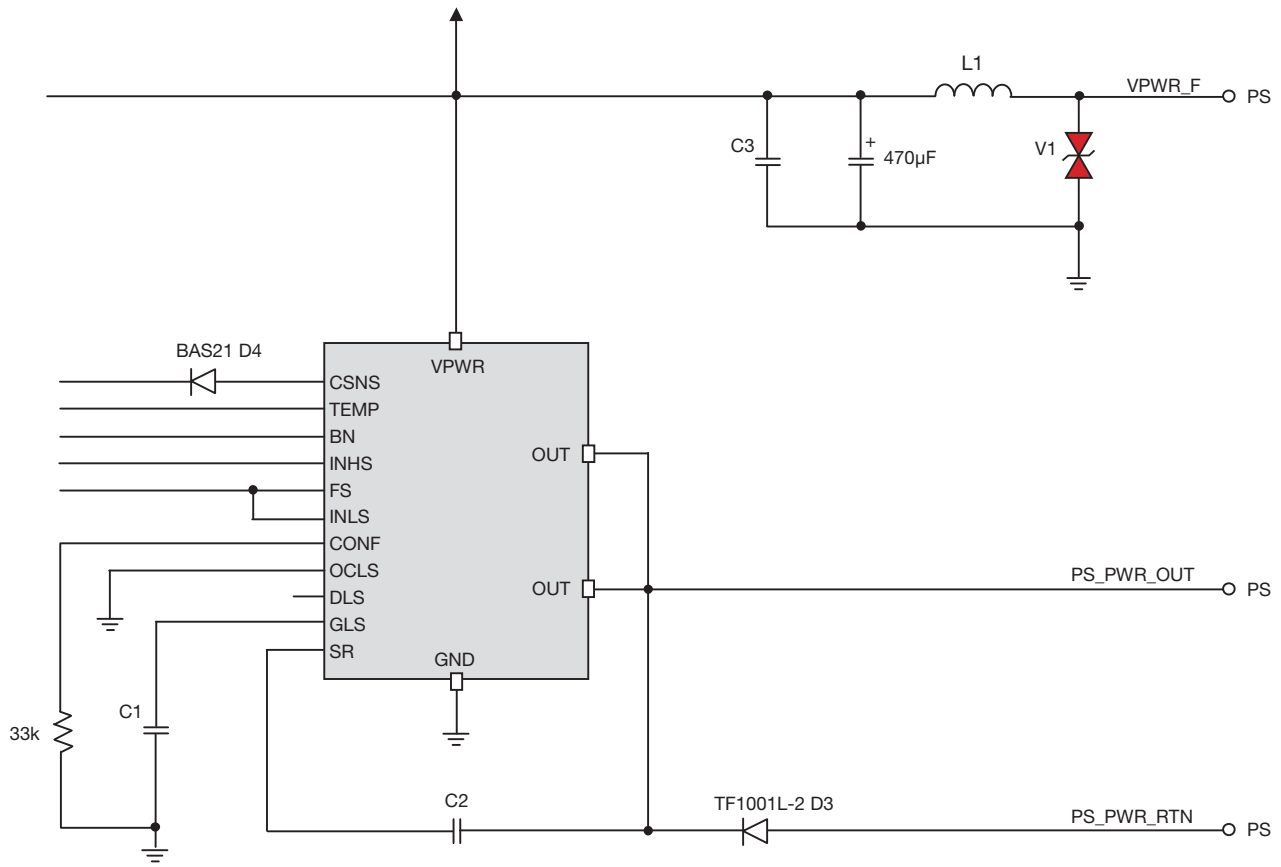

Component	Product	AVX Part number	Specification
V1	Multilayer Varistor	VCAS121018J390RP	1210, 18Vdc, 1.5J, 500A, 3100pF typ

# Automotive Application (TransGuard®)

## AVX Multilayer Transient Voltage Protection Circuit Protection in Automotive Applications

### SEAT MOTOR CIRCUIT

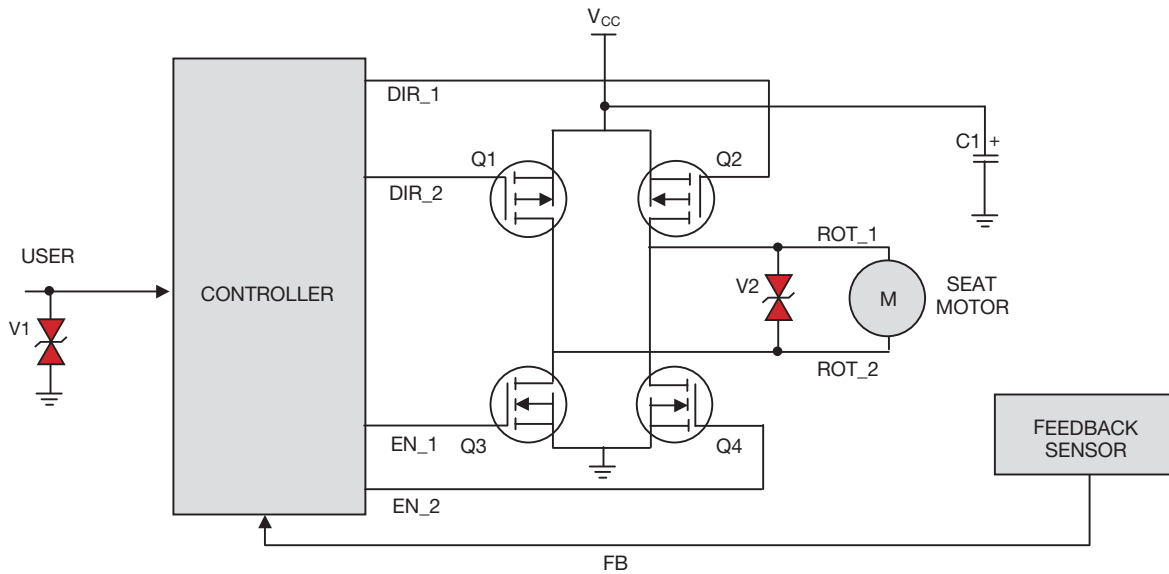

Component	Product	AVX Part number	Specification
V1	Multilayer Varistor	VCAS040218X400WP	0402, 18Vdc, 0.05J, 20A, 65pF typ
V2	Multilayer Varistor	VCAS121018J390RP	1210, 18Vdc, 1.5J, 500A, 3100 pF typ

### LED DOOR LAMP

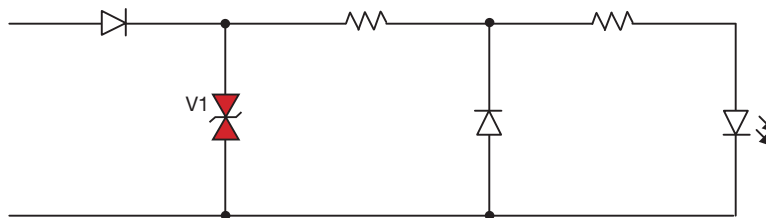

Component	Product	AVX Part number	Specification
V1	Multilayer Varistor	VCAS120618D400RP	1206, 18Vdc, 0.4J, 150A, 900pF typ

# Automotive Application (TransGuard®)

## AVX Multilayer Transient Voltage Protection Circuit Protection in Automotive Applications



### DRIVE BY WIRE – THROTTLE

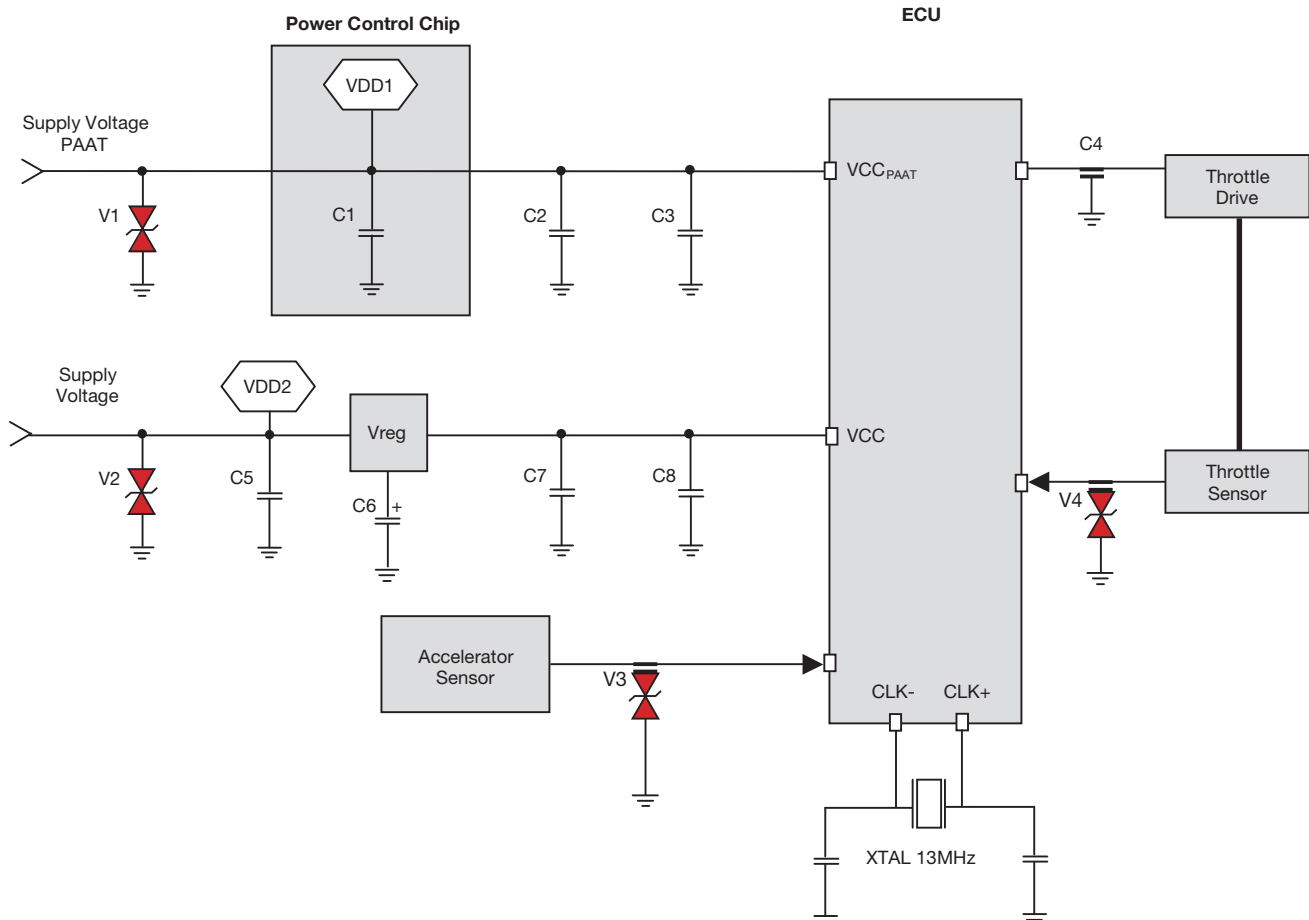

Component	Product	AVX Part number	Specification
V1, V2	Multilayer Varistor	VCAS080518C400DP	0805, 18Vdc, 0.3J, 120A, 550pF typ
V3, V4	TransFeed	V2AF118X500Y3DDP	0805, 18Vdc, 0.05J, 20A, 75pF typ

# Automotive Application (TransGuard®)

## AVX Multilayer Transient Voltage Protection Circuit Protection in Automotive Applications



### KEYLESS ENTRY

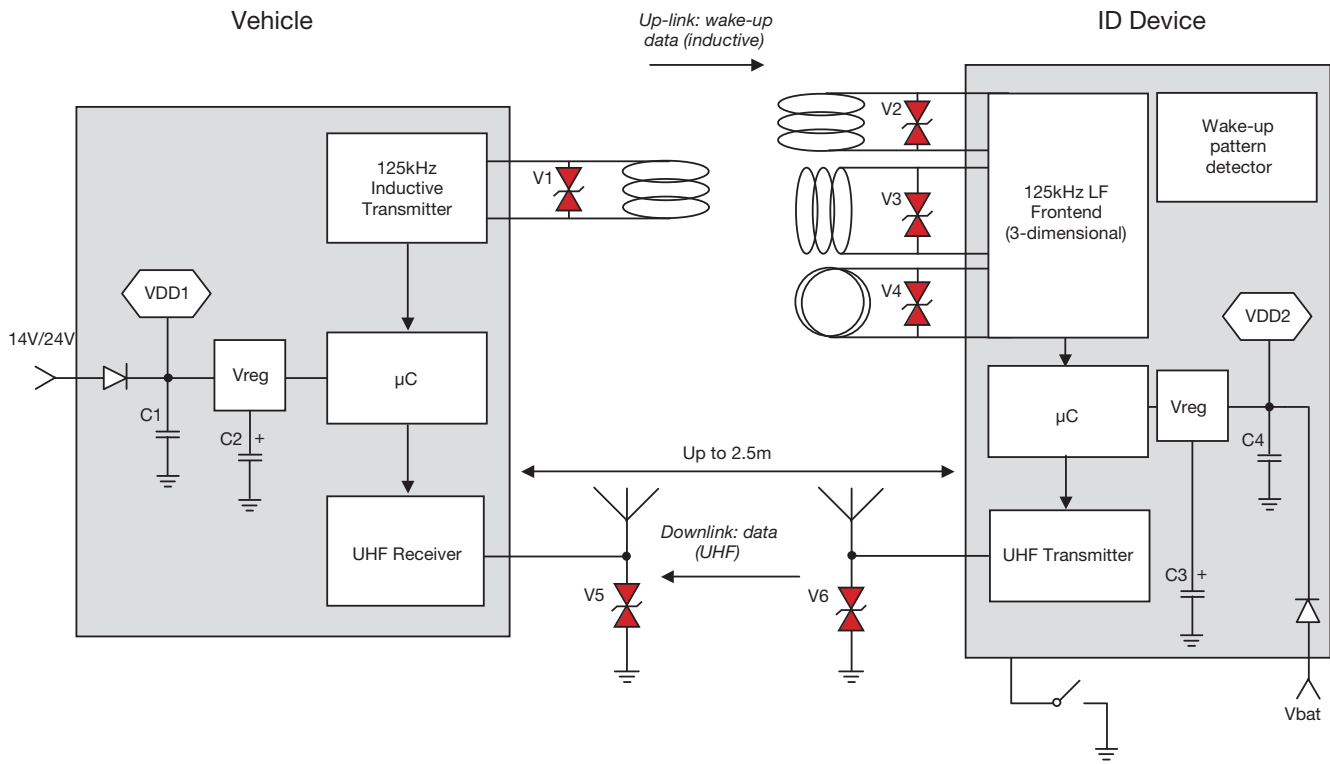

Component	Product	AVX Part number	Specification
V1, V2, V3, V4	Multilayer Varistor	MAV0010DP	0603, 52Vac, 110 Pk-Pk @ 125kHz, 0.015J, 2A, 22pF Max
V5, V6	Multilayer Varistor	VCAS04AG183R0YATWA	0402, 18Vdc, 3pF Max

### VOLTAGE REGULATOR

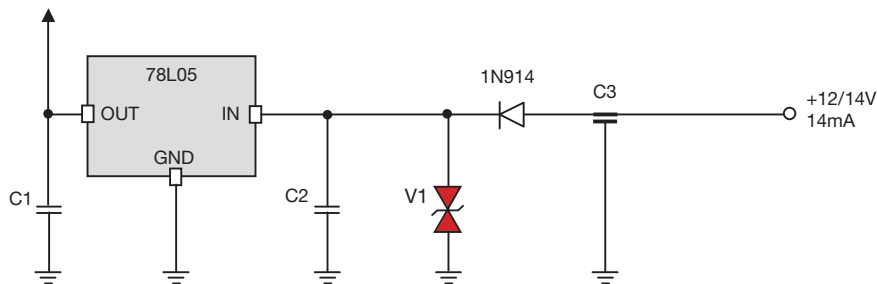

Component	Product	AVX Part number	Specification
V1	Multilayer Varistor	VCAS080518C400DP	0805, 18Vdc, 0.3J, 120A, 550pF typ

# Automotive Application (TransGuard®)

## AVX Multilayer Transient Voltage Protection Circuit Protection in Automotive Applications



### BLUETOOTH

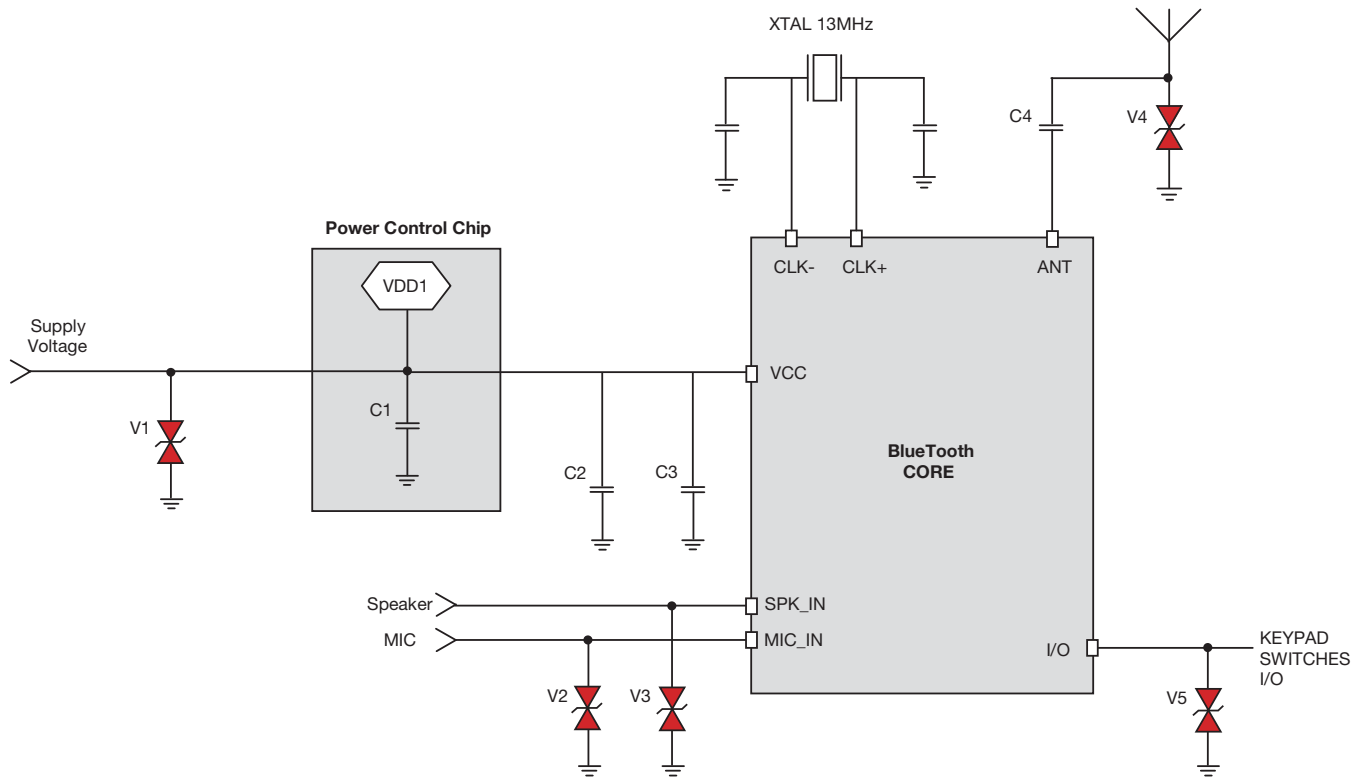

Component	Product	AVX Part number	Specification
V1	Multilayer Varistor	VCAS080518C400DP	0805, 18Vdc, 0.3J, 120A, 550pF typ
V2, V3	Multilayer Varistor	VCAS060314A300DP	0603, 14Vdc, 0.1J, 30A, 350pF typ
V4	Multilayer Varistor	VCAS06AG183R0YAT3A	0603, 18Vdc, 3pF max
V5	Multilayer Varistor	VCAS040218X400WP	0402, 18Vdc, 0.05J, 20A, 65pF typ

# Automotive Application (TransGuard®)

## AVX Multilayer Transient Voltage Protection Circuit Protection in Automotive Applications

### LED DRIVER

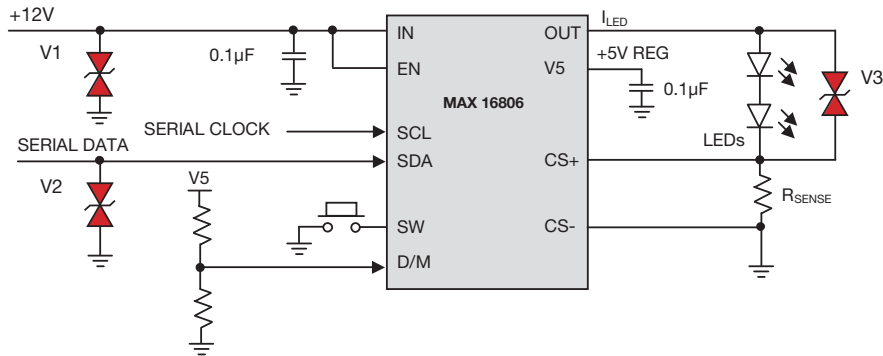

Component	Product	AVX Part number	Specification
V1	Multilayer Varistor	VCAS120618E380	1206, 18Vdc, 0.5J, 200A, 930pF
V2	Multilayer Varistor	VCAS060318A400	0603, 18Vdc, 0.1J, 30A, 150pF
V3	Multilayer Varistor	VCAS06LC18X500	0603, 18Vdc, 0.05J, 30A, 50pF





# Application Notes

- IEC-61000-4 Requirements
- Turn On Time Characteristics of AVX Multilayer Varistor
- The Impact of ESD on Insulated Portable Equipment
- AVX TransGuard Motor and Relay Application Study
- AVX Multilayer Varistors in Automobile MUX Bus Applications

**WHAT IS IEC 61000-4?**

The International Electrotechnical Commission (IEC) has written a series of specifications, IEC 61000-4, which mandate the performance of all electronic devices in a variety of transient and incident RF conditions. This specification requirement resulted as part of Europe’s move toward a single market structure and a desire to formalize and harmonize current member countries’ requirements. As of January 1, 1996, all electronic and electrical items sold to Europe must meet IEC 61000-4 series specifications.

**WHY IS IEC 61000-4 REQUIRED BY EUROPE?**

The various regulatory agencies within Europe feel that the IEC 61000-4 series of specifications is necessary to insure acceptable performance of electronic equipment in a world filled with increasingly more Electromagnetic Interference - EMI. Furthermore, as electronic systems become more portable, and the transient susceptibility of semiconductors increases, government regulations are essential to maintain a minimum level of performance in all equipment. Europe is so serious about the problem that they require that equipment be certified via testing to meet IEC 61000-4 series specifications after 1/1/96 to avoid fines and prosecution.

**HOW DO COMPANIES SELLING ELECTRONIC SYSTEMS MEET IEC 61000-4 PARTS 2-5 SPECIFICATIONS?**

Companies and design engineers must now use protective circuits or devices to meet these requirements. First, a description of IEC 61000-4/2-6 is in order:

**IEC 61000-4-2 ESD TESTING REQUIREMENTS**

All equipment destined for Europe must be able to withstand 10 strikes of ESD waveforms with  $T_r < 1\text{ns}$  in contact discharge mode (preferred) at pre-selected points accessible during normal usage or maintenance. Testing shall be performed at one or more of four (4) severity levels, depending upon equipment category.

Level	Contact Discharge <sup>1</sup> Mode Test Voltage kV	Air Discharge Mode Test Voltage kV
1	2	2
2	4	4
3	6	8
4	8	15

**61000-4-2 Test Conditions**

<sup>1</sup>Preferred mode of testing due to repeatability.

**WAVEFORM PARAMETERS**

Level	Test Voltage Level kV	First Peak of Discharge Current Amps $\pm 10\%$	TR nS	30 nS Current Amps $\pm 30\%$	60 nS Current Amps $\pm 30\%$
1	2	7.5	0.7 -1	4	2
2	4	15	0.7 -1	8	4
3	6	22.5	0.7 -1	12	6
4	8	30	0.7 -1	16	8

Upon completion of the test, the system must not experience upset (data or processing errors) or permanent damage. The waveforms are to be injected at or along the DUT’s body which is accessible in normal set-up and operation.

**IEC 61000-4-3 ELECTROMAGNETIC COMPATIBILITY IMPACT TESTING (EMC)**

This test is concerned with the susceptibility of equipment when subjected to radio frequencies of 27 MHz to 500 MHz. The system must be able to withstand three (3) incident radiation levels:

- Level 1** 1V/m field strength
- Level 2** 3V/m field strength
- Level 3** 10V/m field strength
- Level X** User defined > 10V/m field strength

The system must not experience upset (data or processing errors) or permanent errors.

**IEC 61000-4-4 ELECTRICAL FAST TRANSIENT (EFT) TESTING**

The EFT test is modeled to simulate interference from inductive loads, relay contacts and switching sources. It consists of coupling EFT signals on I/O parts, keyboard cables, communication lines and power source lines. The system, depending upon appropriate severity level, must be able to withstand repetition rates of 2.5 kHz to 5 kHz for  $\geq 1$  minute as follows:

**Open Circuit Output Voltage/10%**

	On Power Supply	On I/O, Signal, Data, Control lines
<b>Level 1</b>	0.5kV	0.25kV
<b>Level 2</b>	1kV	0.5kV
<b>Level 3</b>	2kV	1kV
<b>Level 4</b>	4kV	2kV

#### IEC 61000-4-5 UNIDIRECTIONAL POWER LINE SURGE TEST

The details of this specification for high energy disturbances are being addressed in several drafts under discussion within the EC at this time.

#### IEC 61000-4-6 CONDUCTED RF TEST FROM 9KHZ TO 80MHZ

The details of this specification for conducted broad band RF signals are being addressed in a first edition draft within the EC at this time.

Designers have the option of using AVX TransGuards<sup>®</sup> to meet IEC 61000-4-2, 3 and 4.

In the case of IEC 61000-4-2 TransGuards<sup>®</sup> can be used to suppress the incoming Transient just like a Zener diode would. TransGuards<sup>®</sup>, however, exhibit bipolar characteristics, a faster turn-on-time (<1nS), a better repetitive strike capability and superior thermal stability to the Zener suppression device. Furthermore, TransGuards<sup>®</sup> are typically smaller and lighter when placed on SMT circuit boards. See Figure 1 for data illustrating IEC 61000-4-2 repetitive strike capability.

The TransGuards<sup>®</sup> effective capacitance allows the device to be used to meet IEC 61000-4-3 and 61000-4-4. The device's parallel capacitance can be used as effectively as a capacitor to block low level incident and conducted RF energy. If in the case of some levels of IEC 61000-4-3 and IEC 61000-4-4 when the intensity of pulse is greater than the device's breakdown capability it will then turn on and suppress via MOV means rather than capacitance (as in the small signal case). Effectiveness hinges upon the proper placement of the device within the PCB (which is usually easily accomplished since TransGuards<sup>®</sup> are so small).

#### SUMMARY

AVX TransGuards<sup>®</sup> are exceptionally suited to meet the defined portions of the IEC 61000-4 document. Experimentation is critical to proper choice and selection of devices to suppress 61000-4-3/4. Samples are available from your local sales representative.

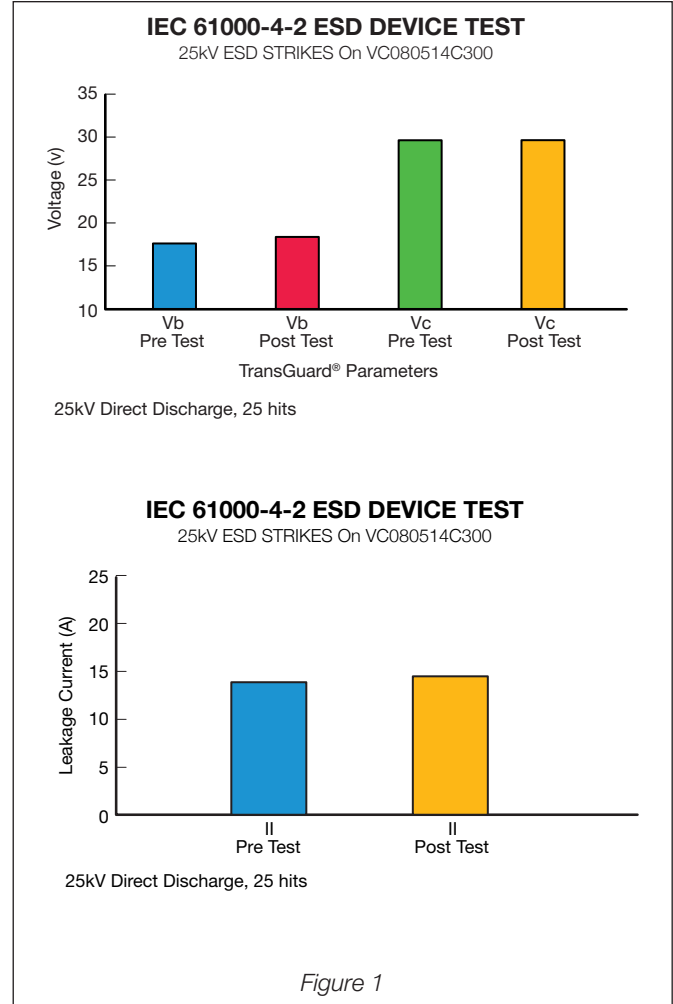

## INTRODUCTION

Due to the growing importance of ESD immunity testing, as required by the EMC Directive, proper selection of voltage suppressor devices is critical. The proper selection is a function of the performance of the device under transient conditions. An ideal transient voltage suppressor would reach its "clamping voltage" in zero time. Under the conditions imposed by the 1991 version of IEC 61000-4-2, the actual turn-on-time must be less than one nanosecond to properly respond to the fast leading edge of the waveform defined in the standard.

It has been found during testing of transient suppressors that the response time is very closely dictated by the packaging of the device. Inductance that is present in the connection between the silicon die and the leads of the device creates an impedance in series with the suppressor device; this impedance increases the overall device response time, reducing the effectiveness of the suppressor device.

The purpose of this paper is to present the Turn on Time characteristics of Multilayer Varistors (MLVs) and to compare the MLV Turn on Time to that of various silicon transient voltage suppressors (SiTVs).

The Turn on Time of a transient voltage suppressor (TVS) is of growing importance since IEC 61000-4-2 now specifies ESD waveform with a rise time < 1 ns. Therefore, TVS's must have a turn on time < 1 ns to effectively suppress ESD. In many, if not all, ESD suppression applications, TVS turn on time can be of more importance than absolute clamping voltage ( $V_c$ ) of the TVS (assuming that the TVS clamping voltage is less than the damage voltage of the circuit or IC).

To measure the turn on time of today's TVS's, a broad cross section of MLVs and SiTVs were chosen. Only surface mount devices were chosen in order to best represent today's TVS current usage/trends and to keep the test matrix to a reasonable level of simplicity. The following devices were tested:

## TEST PROCEDURE

The TVS device under test (DUT) was placed on a PCB test fixture using SN60/40 solder. The test fixture (see Figure 1) was designed to provide an input region for an 8kV contact ESD discharge waveform (per IEC 61000-4-2 level 4 requirements). In addition, the fixture was designed to provide low impedance connections to the DUTs.

SMT MLV	SiTVS
	MA141WA
0603	BAV 99
0805	SOT 23 type
1206	SMB - 500W gull-wing SM device
1210	SMC - 1500W gull-wing SM device

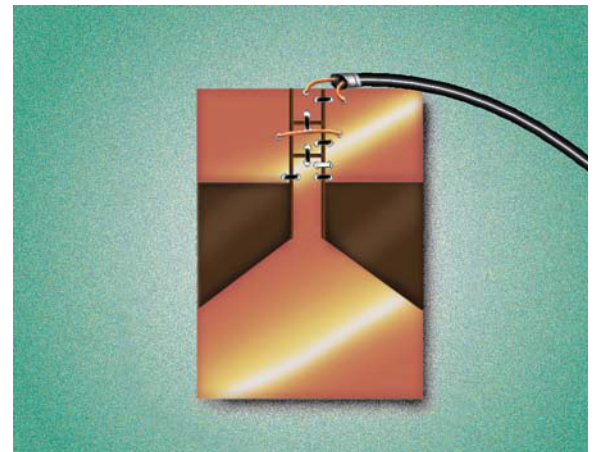

Figure 1. DUT Test Fixture

The ESD pulse was injected to the PCB from a Keytek minizap ESD simulator. Additionally, the fixture was to channel the ESD event to a storage oscilloscope to monitor the suppressor's response. Six resistors were used on the PCB to provide waveshaping and an attenuated voltage to the storage scope (see Figure 2):

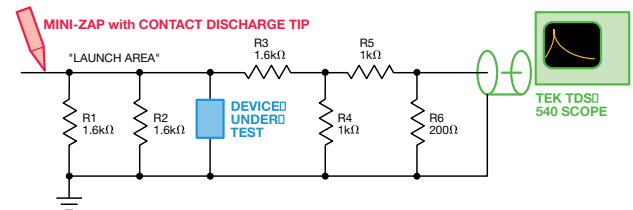

Figure 2. Schematic of Test Set Up

The functions of the resistors are as follows: The resistor values were adjusted in "open circuit" conditions to obtain best open circuit response.

R1, R2 (1.6K) - provide wave shaping during the ESD discharge event

R3 (1.6K), R4 (1K), R5 (1K) - Form a 60 dB Attenuator (1000:1 ratio) for input of Tektronix TDS 540 1 giga sample/second storage oscilloscope

R6 (200 Ω) - provides matching to the 50 ohm coax feeding the TDS 540 oscilloscope.

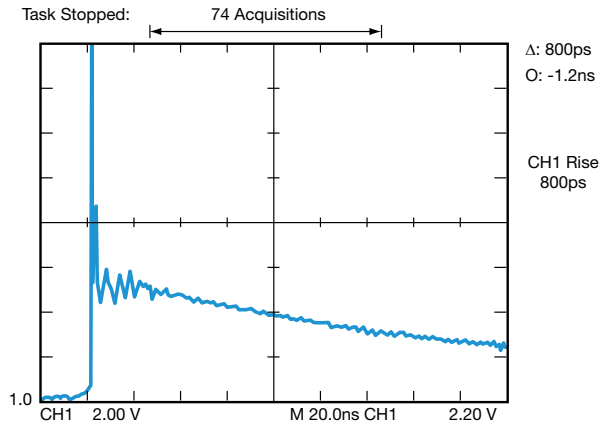

The open circuit response of the ESD test fixture with a 9kV ESD pulse is shown in Figure 3.

Figure 3. Open Circuit Response of Test Fixture to an Injected ESD Waveform

The graph shows the voltage attenuated by a factor of 1000, with a 800ps risetime for the ESD waveform (this agrees with typical data given by Keytek for equipment performance). It should be noted that only the positive polarity was tested. Prior testing showed turn on time was not dependent upon waveform polarity (assuming that DUTs are bidirectional).

## TEST RESULTS

### MLV TURN ON TIME TRANSGUARDS®

The turn on time test results for AVX TransGuards® showed that all case sizes were capable of a sub-nanosecond turn on response. This corresponds favorably with the calculated turn on time of less than 1 ns. Specific performance data follows:

AVX TransGuard®	
CASE SIZE	TURN ON SPEED
0603	< 0.7 ns
0805	< 0.9 ns
1206	< 0.9 ns
1210	< 0.8 ns

## TVS TURN ON TIME

Test results for SiTVs varied widely depending upon the physical size and silicon die mounting configuration of the device. The results agree with several SiTVs manufacturers papers indicating that the absolute response from the silicon die could be < 1 ns. However, when the die is placed in a package, the turn on time delay increases dramatically. The reason for this is the series inductance of the SiTVs packaging decreases the effective response time of the device. Reports of 1-5 ns are frequently referred to in SiTVs manufacturers publications. Further, the turn on times for SiTVs vary dramatically from manufacturer to manufacturer and also vary within a particular manufacturers lot. The data provided in the following table generally agreed with these findings:

SiTVS	
CASE SIZE	TURN ON SPEED
MA141WA	0.8ns
BAV 99	0.9ns to 1.2ns
SOT 23 Type	0.8ns
SMB	1.5ns to 2.2ns
SMC	1.5ns to 3ns

## SUMMARY

This test confirms calculations that show that AVX TransGuards® have a true sub-nanosecond turn on time. Although the silicon die of a SiTVs has a sub-nanosecond response, the packaged SiTVs typically has a response time much slower than a TransGuard®. If the two devices were directly compared on a single graph (see Figure 4), it could be shown that the TransGuard® diverts significantly more power than even the fastest SiTVs devices. Additionally, TransGuards® have a multiple strike capability, high peak inrush current, high thermal stability and an EMI/RFI suppression capability which diodes do not have.

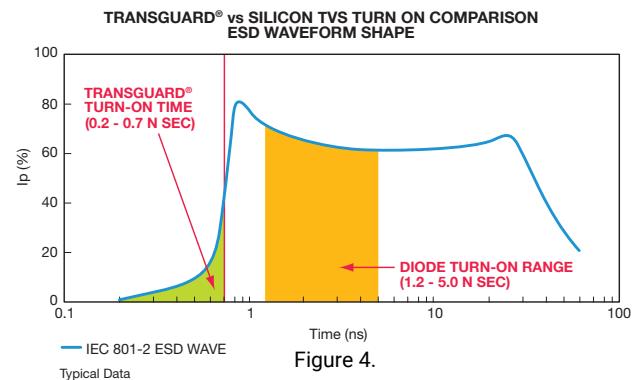

The purpose of this discussion is to recap the impact ESD has on portable, battery powered equipment. It will be shown that ESD can cause failures in “floating ground systems” in a variety of ways. Specifically, ESD induced failures can be caused by one or more of its complex components:

**Predischarge** - Corona Generated RF

**Predischarge** - E Field

**Discharge** - Collapsing E Field

**Discharge** - Collapsing H Field

**Discharge** - Current Injection...Voltage...Additional Fields

With this in mind it will be shown that the only way to insure equipment survivability to ESD is to use a Transient Voltage Suppressor (in addition to proper circuit layout, decoupling, and shielding).

In order to get a better understanding of what happens in an ESD event the charge developed by a human body should be defined. The ESD schematic equivalent of the human body model is shown in Figure 1. Typically, the charge developed on a person can be represented by a 150pF capacitor in series with a resistance of 330 ohms. The energy of an ESD waveform generated from this model is  $Q = 1/2 CV^2$  where Q = total energy in Joules, C = capacitance of the human body model in farads and V = charging voltage in volts.

Voltages can be as high as 25 kV, however typical voltages seen are in the 8 to 15 kV regions.

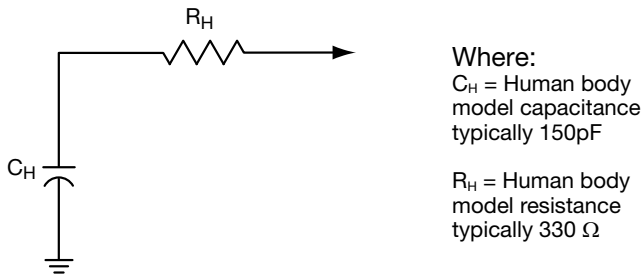

Figure 1. Human Body Model

## PREDISCHARGE E FIELD FAILURES

Now that we have a definition of the basic ESD human body model we can discuss the predischarge E field failure mode.

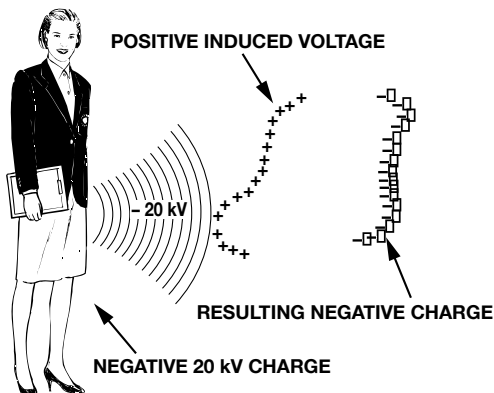

Figure 2. Pre-Discharge Scenario

In the predischarge scenario (Figure 2) a human charged to -20 kV may approach a battery powered “system” on a table. As the person reaches toward the system electrostatics dictate that the system will have an equal and opposite charge on the system’s surface nearest to the person. Since the system we are approaching is isolated from ground, the charge is only redistributed among the device. (If the system were grounded a current would be generated by the loss of electrons to ground. The system would then become positive relative to ground). The rate of approach of the human body model affects the charging current to a small extent. However, most importantly, it is the electrostatic field and the unequal voltages which developed across the equipment that cause the destruction of components within the system. In general, unprotected IC’s (particularly CMOS) are susceptible to damage due to induced E field voltages. This problem is further complicated by the device type and complexity and the fact that the breakdown voltage of a generic IC will vary greatly from manufacturer to manufacturer (Figure 3). This brief discussion should be adequately convincing that electrostatically induced E field can impact system reliability. IC protection can be achieved by placing a transient suppressor on the most susceptible pins of the sensitive IC’s (e.g., Vcc and I/O pins, etc.).

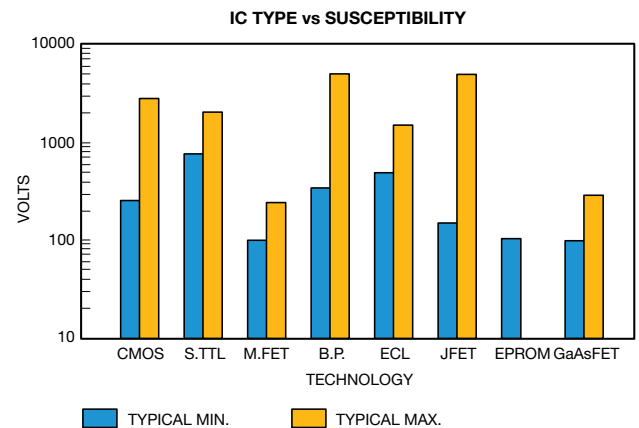

Figure 3. IC Type E Field Susceptibility

## CONTACT DISCHARGE FAILURES

As the charged person gets closer to the system, the situation is more complex. First a much more detailed human body model is needed to represent the complex transmission line which will transport energy to the system (see Figure 4). In this discussion we will only consider the case of a single contact discharge. In the real world, however, multiple discharges will likely occur (possibly caused by a person’s hand reacting to an ESD spark and then touching the system again, etc.).

In contact discharge, when a charged person approaches the system, E fields are induced. As the person gets closer to the system, the field intensity becomes greater, eventually reaching a point large enough to draw an arc between the person and the system. In contrast to the noncontrast

E field example, the speed of approach is of great importance in the contact discharge model. A fast approach causes a more intensive discharge and faster current rise times and peaks.

The model shown on Figure 4 can be broken up into 4 sections for the sake of simplification. The first section is the human body model input voltage. This section is identical to the simplified human body model shown in Figure 1.

Section 2 takes into account how the human body model gets the energy to the system. This section considers the inductance, resistance and capacitance of the human's arm and finger and its capacitance relative to ground and the system.

The third section is the inductance and resistance of the arc which is created as section 2 approaches the system (Section 4).

Section four is the system itself.

The combination of the capacitances and inductances in these sections form a complex network of LC tank circuits which will inject a variety of waveforms (transients) into the system. These waveforms will range in frequency from very high (5 GHz) to high (100 MHz) to low (20-50 MHz) plus a variety of under damped and over damped waveforms.

Finally, in addition to current/voltage injection occurring as a result of the discharge, there will be collapsing E and H fields and significant high frequency RF waveforms. Many times these waveforms propagate into shielded equipment and cause system/device failures.

## SUMMARY

Designers may be inclined to think that E field variation due to near field electrostatics (as in the person being close to the system but not touching it) can be eliminated by shielding. This is usually not the case because it is difficult to get a tight columbic shield around internal circuitry without incurring significant additional manufacturing costs. Additionally, the shielding will likely have seams, ventilation holes, or I/O ports which represent a significant portion of a wavelength (at 5 GHz). Therefore, E fields and corona generated RF can be a problem. Finally, if the system has I/O connectors, keyboards, antennas, etc., care must be taken to adequately protect them from direct/and indirect transients. The most effective resolution is to place a TransGuard® as close to the device in need of protection as possible. These recommendations and comments are based upon case studies, customer input and Warren Boxleitner's book Electrostatic Discharge and Electronic Equipment - A Practical Guide for Designing to Prevent ESD Problems.

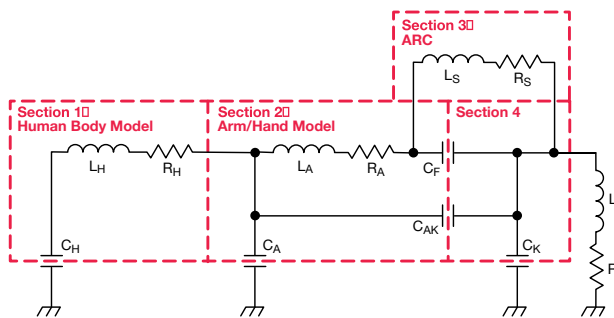

- Where:
- $C_H$  = Lumped capacitance between the human body and earth
  - $R_H$  = Lumped resistance of the human body
  - $L_H$  = Lumped inductance of the human body
  - $C_A$  = Lumped capacitance between the person's arm and earth
  - $C_{AK}$  = Lumped capacitance between the person's arm (and near portions of the body) and the keyboard
  - $R_A$  = Lumped resistance of the person's arm's discharge path
  - $L_A$  = Lumped inductance of the person's arm's discharge path
  - $C_F$  = Capacitance between person's finger, hand, and the keyboard
  - $C_K$  = Lumped capacitance keyboard to earth
  - $R_K$  = Lumped resistance of the keyboard earth ground path
  - $L_K$  = Lumped inductance of the keyboard earth ground path

Figure 4. Contact Discharge Model

### PURPOSE

A significant number of end customers have experienced failures of circuitry in and around low voltage relays and motors. Additionally, EMI problems have been associated with running motors.

This study is aimed at evaluating how TransGuards® can reduce EMI from running motors and clamp transients generated from relays and motors during power off.

### DESCRIPTION

Three different motors and two different relays were chosen to represent the wide range of possible devices used by designers. Device choices were as follows:

#### MOTORS

- Cramer 8001 series Geared Motor  
12V, 30rpm (4800 RPM armature speed) 170ma  
Start/Run Torque 30oz
- Comair Rotron DC Biscut Fan - 24V, 480ma
- Comair Rotron DC Biscut Fan - 12V, 900ma

#### RELAYS

- Potter and Brumfield 24V Relay  
1/3 HP 120V AC, 10A 240 VAC Rating
- Potter and Brumfield 12V Relay  
1/3 HP 120V AC, 10A 240 VAC Rating

A Tektronix TDS 784A four channel 1GHz 4G S/s digitizing storage scope was used to capture the -1/2 LI2 transient peak from the relays and motors.

A x10 probe was connected to the scope and one leg of the relay/motor coil; the probe's ground was connected to the other relay coil/motor wire. The scope was triggered on the pulse and waveforms printed.

When suppression was introduced into the circuit, it was placed directly on the relay coils/motor lead wires. The axial TransGuard® and capacitors had a 19mm (3/4") total lead length in each case. Upon careful consideration, it was determined that this was a fairly common lead length for such applications.

### SUMMARY

#### GEARED MOTOR

The Cramer geared motor was tested while running (under load) to determine its "on state" noise as well as under loaded turn off conditions. Both TransGuards® and ceramic capacitors were tested to determine the level of protection they offer.

A 14V axial TransGuard® provided the best protection during running and turn off. The VA100014D300 TransGuard® cut the 60V unprotected turn off voltage spike to 30V. It also cut the on state noise to 4.0V pk-pk due to its internal capacitance. The following is a summary of measured voltages (scope traces are shown in Figures 1, 1A, 2, 2A).

Test Condition	Transient without Protection	Transient with .1µF cap	Transient with .01µF cap	Transient with 14v TransGuard®
Geared motor at turn off	60V	32V	48V	30V
Geared motor during running	12V pk-pk	4.0V pk-pk	4.0V pk-pk	4.0V pk-pk

Fig. 1. Geared Motor Transient at Turnoff without protection 60 V Gear Motor 20 V/Division

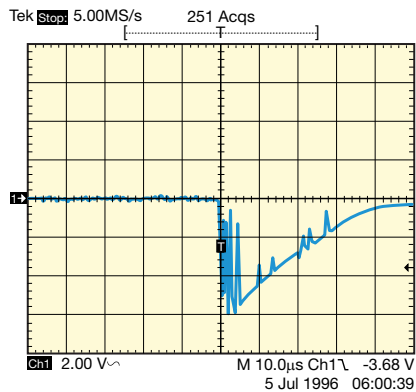

Fig. 2. Geared Motor Running noise without protection 12 V pk-pk 2 V/ Division

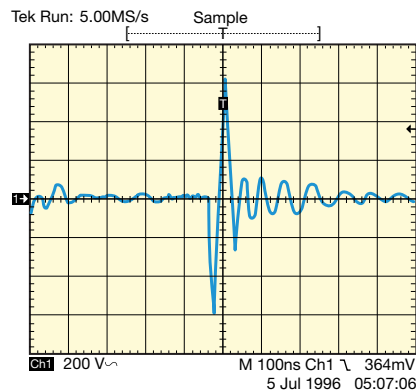

Fig. 1A. Geared Motor Transient at Turnoff with 14 V TransGuard® 30 V 10 V/Division

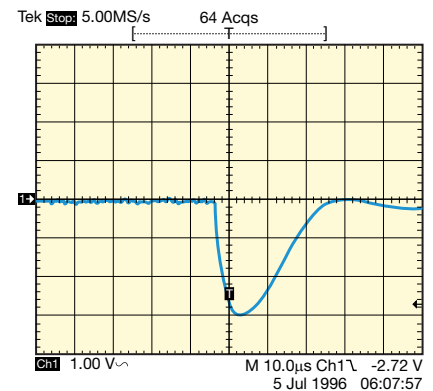
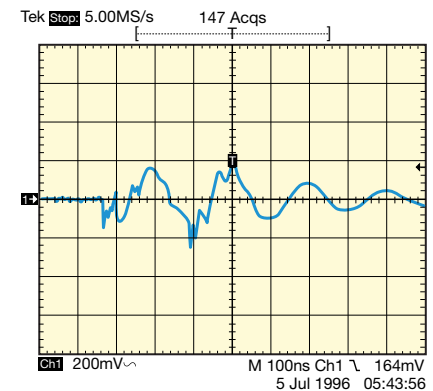

Fig. 2A. Geared Motor Running with 14 V TransGuard® 4 V pk-pk 2 V/ Division





### BISCUT FAN

The Comair 24V and 12V biscut fans were tested only for transients at turn off. Results of those tests are shown in the table at the right (as well as slope traces 3, 3A, 4, 4A).

Motor Type	Transient without Protection	Transient with .1µF cap	Transient with .01µF cap	Transient with 14v TransGuard®
24V Fan	165V	120V	140V	65V(1)
12V Fan	60V	52V	64V	30V(2)

(1) VA100030D650 TransGuard® / (2) VA100014D300 TransGuard®

Fig. 3. 24 V Biscut Fan without protection  
165 V Biscut 50 V/  
Division

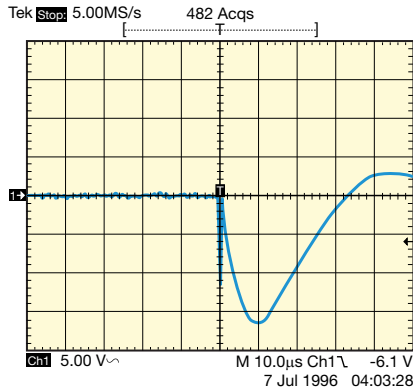

Fig. 3A. 24 V Biscut Fan with 30 V TransGuard®  
65 V 50 V/Division

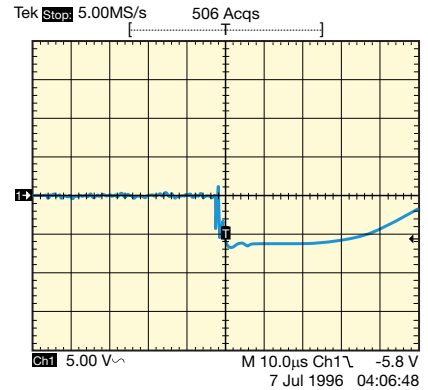

Fig. 4. 12 V Biscut Fan without protection  
60 V 20 V/Division

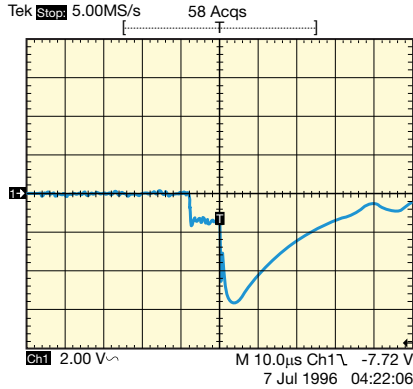
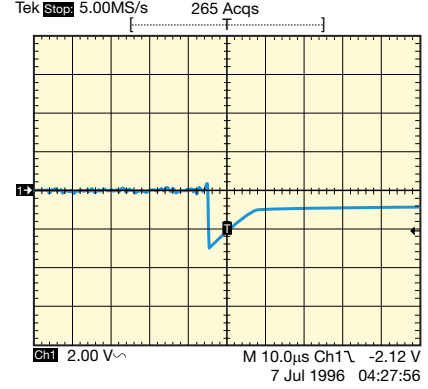

Fig. 4A. 12 V Biscut Fan with 14 V TransGuard®  
30 V 20 V/Division



### RELAYS

The 12V and 24V relays were tested only for transients at turn off. The results of those tests are shown in the table at the right (as well as scope traces 5, 5A, 6, 6A).

Relay Type	Transient without Protection	Transient with .1 $\mu$ F cap	Transient with .01 $\mu$ F cap	Transient with 14v TransGuard®
24V	44V	24V	28V	28V(3)
12V	105V	63V	100V	30V(4)

(3) VA100026D580 TransGuard® / (4) VA100014D300 TransGuard®

Fig. 5. 24 V Relay Transient without protection  
44 V 10 V/Division

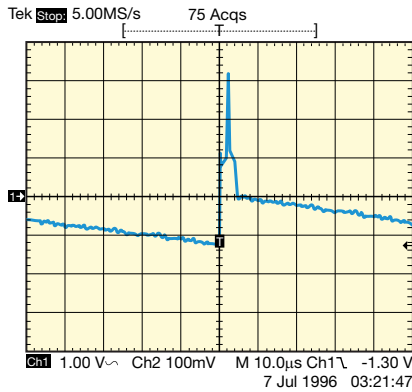

Fig. 5A. 24 V Relay Transient with 26 V TransGuard®  
10 V/Division

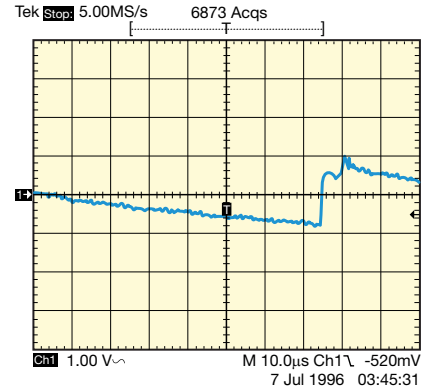

Fig. 6. 12 V Relay Transient without protection  
105 V 50 V/Division

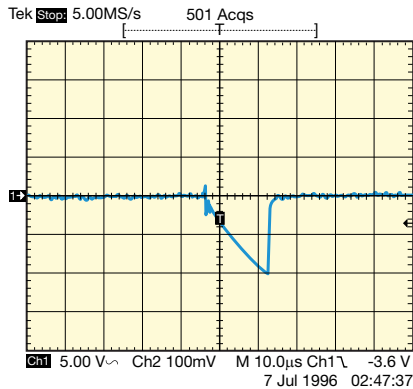
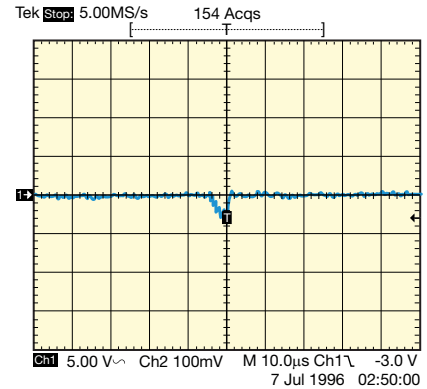

Fig. 6A. 12 V Relay Transient with 14 V TransGuard®  
30 V 50 V/Division



## CONCLUSIONS

TransGuards® can clamp the wide range of voltages coming from small/medium motors and relays due to inductive discharge. In addition, TransGuards® capacitance can help reduce EMI/RFI. Proper selection of the TransGuards® voltage is critical to clamping efficiency and correct circuit operation.

The current trend in automobiles is towards increased performance, comfort and efficiency. To achieve these goals, automobile companies are incorporating an ever increasing array of electronics into cars. As the electronic content within cars increases, auto manufacturers are utilizing multiplex bus designs to network all the sensors to a central point (usually the engine control unit [ECU]). Multiplex lines save wiring harness weight and decrease the harness' complexity, while allowing higher communication speeds. However, the multiplex structure tends to increase the occurrence and severity of Electromagnetic Interference (EMC) and Electrostatic Discharge (ESD).

Multilayer varistors (MLVs) are a single component solution for auto manufacturers to utilize on multiplex nodes to eliminate both ESD and EMC problems. MLVs also offer improved reliability rates (FIT rates <1 failure/billion hours) and smaller designs over traditional diode protection schemes.

**TYPICAL MUX NODE APPLICATION**

There are a variety of SAE recommended practices for vehicle multiplexing (J-1850, J-1939, J-1708, J-1587, CAN). Given the number of multiplexing specifications, it is easy to understand that bus complexity will vary considerably.

Each node has an interface circuit which typically consists of a terminating resistor (or sometimes a series limiting resistor), back to back Zener diodes (for over voltage protection) and an EMC capacitor. Such a method is compared to that of a multilayer varistor in Figure 1.

As the schematic in Figure 1 illustrates, the implementation of MLV protection methods greatly simplifies circuit layout, saves PCB space and improves system reliability. The MLV offers many additional electrical improvements over the Zener/passive schemes. Among those advantages are higher multiple strike capability, faster turn on time and larger transient overstrike capability. Further clarification on the types of varistors compared to the performance of Zener diodes follows.

**CONSTRUCTION AND PHYSICAL COMPARISON**

The construction of Zinc Oxide (ZnO) varistors is a well known, relatively straightforward process in which ZnO grains are doped with cobalt, bismuth, manganese and other oxides. The resulting grains have a Schottky barrier at the grain interface and a typical grain breakdown voltage (Vb) of approximately 3.6V per grain.

Currently, there are two types of varistors. Single layer varistors (SLVs) – an older technology referred to as “pressed pill,” typically are larger, radial leaded components designed to handle significant power. Multilayer varistors (MLVs) are a relatively new technology packaged in true EIA SMT case sizes.

Beyond the ZnO material system and grain breakdown similarity, MLVs and SLVs have little in common. That is, to design a low voltage SLV, the grains must be grown as large as possible to achieve a physically large enough part to be handled in the manufacturing process. Typically it is very difficult to obtain a consistent grain size in a low voltage SLV process.

The electrical performance of SLV is affected by inconsistent grain size in two ways. First, low voltage SLVs often exhibit an inconsistent Vb and leakage current (IL) from device to device within a particular manufacturing lot of a given rating. This contributes to early high voltage repetitive strike wear out.

Secondly, SLVs with similar voltage and energy ratings as MLVs typically exhibit a lower peak current capability due in part to increased resistance of the long current path of the large grains. This contributes to early repetitive high current wear out.

At higher voltages, the grain size variations within SLVs play a much smaller percentage role in Vb and leakage current values. As a result, SLVs are the most efficient cost effective way to suppress transients in high voltages (e.g., 115 VAC, 220 VAC).

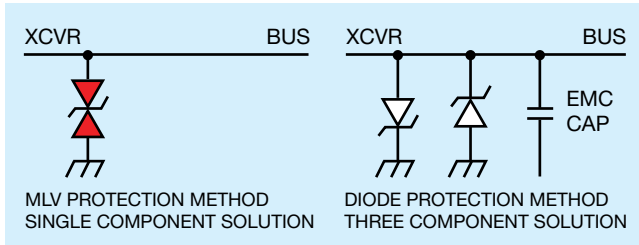

Figure 1. Comparison of past node protection methods to MLV node protection methods.

To more clearly understand the functional structure of a MLV, see the equivalent electrical model shown in Figure 2.

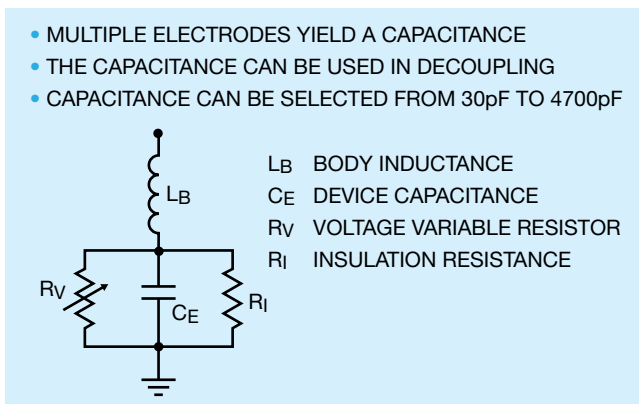

Figure 2. TransGuard® Equivalent Model.

#### MLV MANUFACTURE

The construction of a MLV was made possible by employing a variety of advanced multilayer chip capacitors (MLCC) manufacturing schemes coupled with a variety of novel and proprietary ZnO manufacturing steps. In the MLCC process, thin dielectrics are commonly employed to obtain very large capacitance values. It is that capability to design and manufacture multilayer structures with dielectric thicknesses of  $\leq 1$  mil that allows MLVs to be easily made with operating/ working voltages ( $V_{wm}$ ) as low as 3.3V (for use in next generation silicon devices).

Once a particular working voltage has been determined (by altering the ZnO dielectric thickness), the multilayer varistor's transient energy capability is determined by the number of layers of dielectric and electrodes. It is, therefore, generally easy to control the grain size and uniformity within a MLV due to the relative simplicity of this process.

MLVs exhibit capacitance due to their multiple electrode design and the fact that ZnO is a ceramic dielectric. This capacitance can be utilized with the device's series inductance to provide a filter to help limit EMI/RFI. The equivalent model of a MLV is shown in Figure 2.

MLVs are primarily used as transient voltage suppressors. In their "on" state, they act as a back-to-back Zener, diverting to ground any excess, unwanted energy above their clamping voltage. In their "off" state, they act as an EMC capacitor (capacitance can be minimized for high speed applications). A single MLV, therefore, can replace the diode, capacitor and resistor array on multiplex node applications.

Any TVS will see a large number of transient strikes over its lifetime. These transient strikes will result from different events such as well known ESD HBM, IC MM, alternator field decay, load dump models and uncontrolled random events. It is because of the repetitive strikes that all TVS suppressors should be tested for multiple strike capability. Typically, a TVS will fail due to high voltage, high current or over-energy strikes.

High voltage repetitive strikes are best represented by IEC 61000-4-2 8kV waveforms. MLVs demonstrate a greatly superior capability to withstand repetitive ESD high voltage discharge without degradation.

High current repetitive strikes are represented by 8x20 $\mu$ s 150A waveforms. A comparison between MLVs, SLVs and SiTVS is shown in Figures 3A, B, C respectively.

#### SILICON TVS MANUFACTURE

The construction of a silicon TVS departs dramatically from that of either single layer varistor or multilayer varistor construction. Devices are generally produced as Zener diodes with the exception that a larger junction area is designed into the parts and additional testing was likely performed. After the silicon die is processed in accordance to standard semi-conductor manufacturing practice, the TVS die is connected to a heavy metal lead frame and molded into axial and surface mount (SMT) configuration.

#### MLVS COMPARED TO DIODES

The response time for a silicon diode die is truly sub-nanosecond. The lead frame into which the die is placed and the wire bonds used for die connections introduce a significant amount of inductance. The large inductance of this packaging causes a series impedance that slows the response time of SiTVS devices. A best case response time of 8nS on SOT23 and a 1.5nS to 5nS response time on SMB and SMC products respectively are rather typical. MLVs turn on time is  $< 7$ nS. MLVs turn on time is faster than SiTVS and that fast turn on time diverts more energy and current away from the IC than any other protection device available.

#### CONCLUSION

The technology to manufacture MLVs exists and allows the manufacture of miniature SMT surge suppressors. MLVs do not have the wear out failure mode of first generation (single layer) varistors. In fact, MLVs exhibit better reliability numbers than that of TVS diodes. MLVs are a viable protection device for auto multiplex bus applications.

Written by Ron Demcko

Originally printed in EDN PRODUCTS EDITION December 1997 by CAHNERS PUBLISHING COMPANY

#### 150 AMP Current Repetitive Strike Comparison

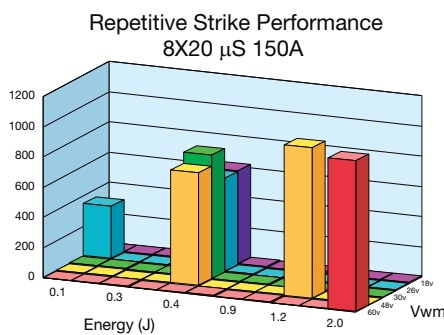

Figure 3A. Multilayer Varistor.

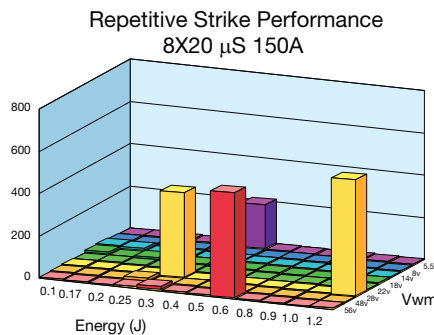

Figure 3B. Single Layer Varistor

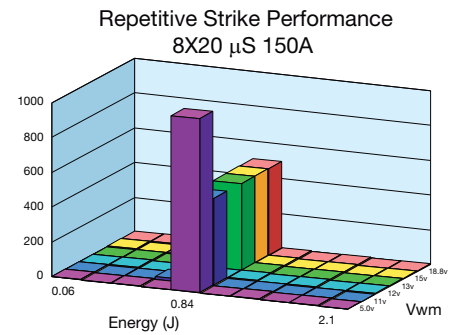

Figure 3C. Silicon TVS.



# Soldering – Assembly Guidelines

**TRANSGUARD® SURFACE MOUNT DEVICES**

The move toward SMT assembly of Transient Voltage Suppressors (TVS) will continue accelerating due to improved long-term reliability, more efficient transient voltage attenuation and size/functionality/cost issues.

TransGuards® are uniquely suited for wide-scale usage in SMT applications. TransGuards® exhibit many advantages when used in SMT assemblies. Among them are:

- Available in standard EIA chip sizes 0402/0603/0805/ 1206/1210.
- Placed with standard equipment (8mm tape and reel).
- Processed with fewer guidelines than either ceramic chip or resistor chip devices.
- Exhibit the highest energy/volume ratio of any EIA size TVS.

This general guideline is aimed at familiarizing users with the characteristics of soldering multilayer SMT ZnO TransGuards®. TransGuards® can be processed on wave or infrared reflow assembly lines. For optimum performance, EIA standard solder pads (land areas) shown in Figure 1 are recommended regardless of the specific attachment method.

**Dimensions: mm (inches)**

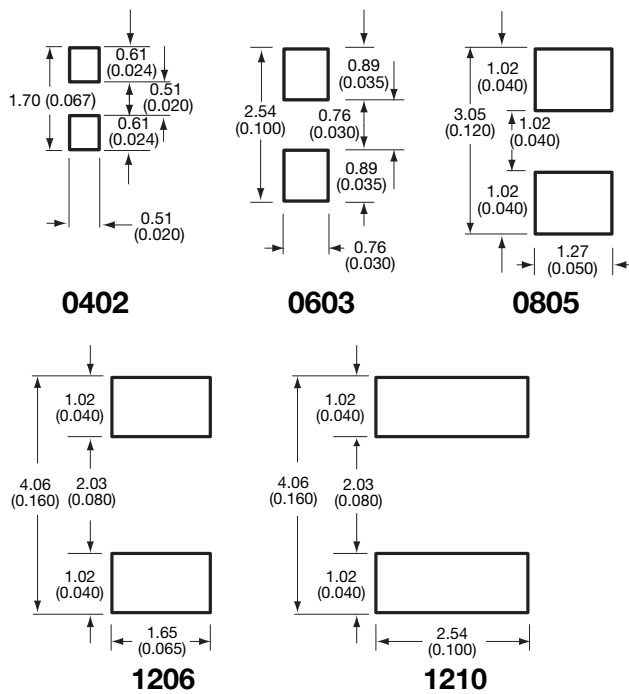

Figure 1: TransGuard® Solder Pad Dimensions

**STORAGE**

Good solderability of plated components is maintained for at least twelve months, provided the components are stored in their “as received” packaging at less than 30°C and 85% RH.

**SOLDERABILITY**

Plated terminations will be well soldered after immersion in a 60/40 tin/lead solder bath at 235°C ±5°C for 5 ±1 seconds.

**LEACHING**

Plated terminations will resist leaching for at least 30 seconds when immersed in 60/40 tin/lead solder at 260°C ±5°C.

**RECOMMENDED SOLDERING PROFILES**

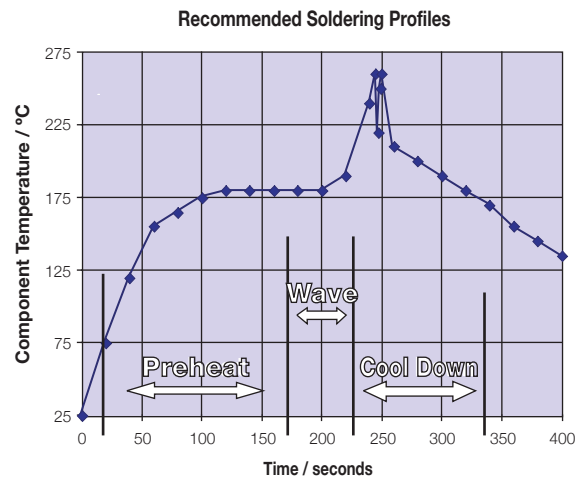
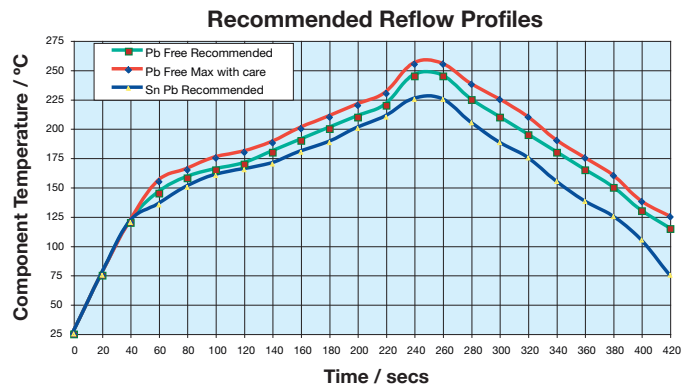

**GENERAL**

Surface mount multilayer varistors (MLVs) are designed for soldering to printed circuit boards or other substrates. The construction of the components is such that they will withstand the time/temperature profiles used in both wave and reflow soldering methods.

**HANDLING**

MLVs should be handled with care to avoid damage or contamination from perspiration and skin oils. The use of tweezers or vacuum pickups is strongly recommended for individual components. Bulk handling should ensure that abrasion and mechanical shock are minimized. Taped and reeled components provide the ideal medium for direct presentation to the placement machine.

**PREHEAT**

It is important to avoid the possibility of thermal shock during soldering and carefully controlled preheat is therefore required. The rate of preheat should not exceed 4°C/second and a target figure 2°C/second is recommended.

**SOLDERING**

Mildly activated rosin fluxes are preferred. The minimum amount of solder to give a good joint should be used. Excessive solder can lead to damage from the stresses caused by the difference in coefficients of expansion between solder, chip and substrate. AVX terminations are suitable for all wave and reflow soldering systems. If hand soldering cannot be avoided, the preferred technique is the utilization of hot air soldering tools.

**COOLING**

Natural cooling in air is preferred, as this minimizes stresses within the soldered joint. When forced air cooling is used, cooling rate should not exceed 4°C/second.

**CLEANING**

Flux residues may be hygroscopic or acidic and must be removed. AVX MLVs are acceptable for use with all of the solvents described in the specifications MIL-STD-202 and EIA-RS-198. Alcohol-based solvents are acceptable and properly controlled water cleaning systems are also acceptable. Many other solvents have been proven successful, and most solvents that are acceptable to other components on circuit assemblies are equally acceptable for use with MLVs.

**POST SOLDER HANDLING**

Once the components are soldered to the board, any bending or flexure of the PCB applies stresses to the soldered joints of the components. For leaded devices, the stresses are absorbed by the compliancy of the metal leads and generally don't result in problems unless the stress is large enough to fracture the soldered connection.

Surface mount devices are more susceptible to such stress because they don't have compliant leads and are brittle in nature. The most frequent failure mode is high leakage current (or low breakdown voltage). Also, a significant loss of capacitance due to severing of contact between sets of internal electrodes may be observed.

Cracks caused by mechanical flexure are very easily identified and generally take one of the following two general forms:

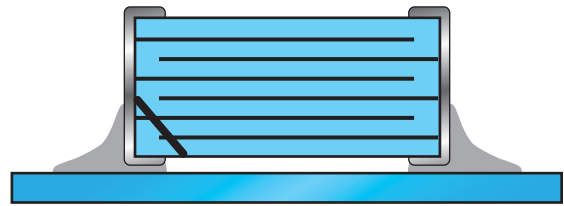

Type A:

Angled crack between bottom of device to top of solder joint.



Type B:

Fracture from top of device to bottom of device.

Mechanical cracks are often hidden underneath the termination and are difficult to see externally. However, if one end termination falls off during the removal process from PCB, this is one indication that the cause of failure was excessive mechanical stress due to board flexure.

**COMMON CRACKS OF MECHANICAL CRACKING**

The most common source for mechanical stress is board depanelization equipment, such as manual breakpart, v- cutters and shear presses. Improperly aligned or dull cutters may cause torquing of the PCB resulting in flex stresses being transmitted to components near the board edge. Another common source of flexural stress is contact during parametric testing when test points are probed. If the PCB is allowed to flex during the test cycle, nearby components may be broken.

A third common source is board-to-board connections at the vertical connectors where cables or other PCBs are connected to the PCB. If the board is not supported during the plug/unplug cycle, it may flex and cause damage to nearby components.

Special care should also be taken when handling large (>6" on a side) PCBs since they more easily flex or warp than smaller boards.

**REWORKING ASSEMBLIES**

Thermal shock is common in MLVs that are manually attached or reworked with a soldering iron. AVX strongly recommends that any reworking of MLVs be done with hot air reflow rather than soldering irons.

Direct contact by the soldering iron tip often causes thermal cracks that may fail at a later date. If rework by soldering iron is absolutely necessary, it is recommended that the wattage of the iron be less than 30 watts and the tip temperature be <300°C. Rework should be performed by applying the solder iron tip to the pad and not directly contacting any part of the component.

**VARISTOR SOLDERABILITY**

Historically, the solderability of Multilayer Varistors (MLVs) has been a problem for the electronics manufacturer. He was faced with a device that either did not wet as well as other electronic components, or had its termination material leached away during the assembly process. However, by utilizing proprietary procedures, AVX Corporation provides the market with a MLV that has solderability comparable to that of other electronic components, and resists leaching during assembly.

**BACKGROUND**

The basic construction of an unplated MLV is presented in Figure 1. The external termination is a metal that connects the internal electrodes to

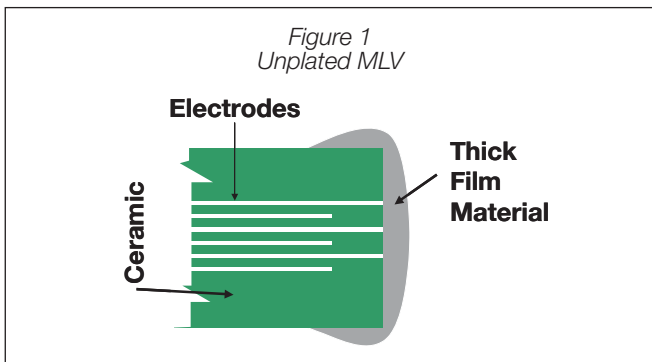

the circuitry of the assembly using the MLV. The external electrode must accomplish two goals. First, it must be sufficiently solderable to allow the solder used in assembly to wet the end of the chip and make a reliable connection to the traces on the circuit board. Second, it must be robust enough to withstand the assembly process. This is particularly important if wave soldering is used. Unfortunately these two goals are competing. In order to achieve good solderability, an alloy high in silver content is chosen. However, this alloy is prone to leaching during assembly, so an additional metal is added to improve the leach resistance. While this improves the leach resistance, this addition makes the termination less solderable. The results are either terminations that leach away, or do not solder well (see the photographs in Figure 2).

Clearly, a plated termination system (as seen in Figure 3) is desired. This system, which is typical of other electronic components such as capacitors and resistors, produces a much better assembled product.

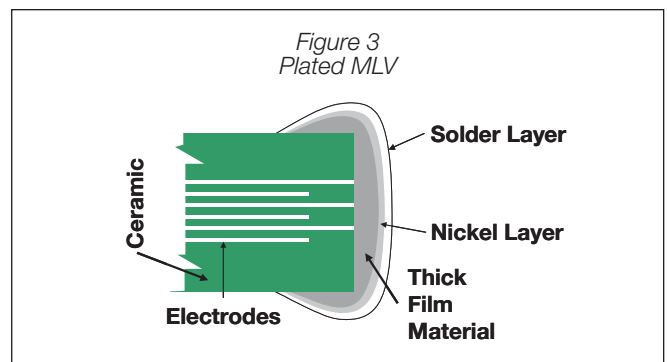
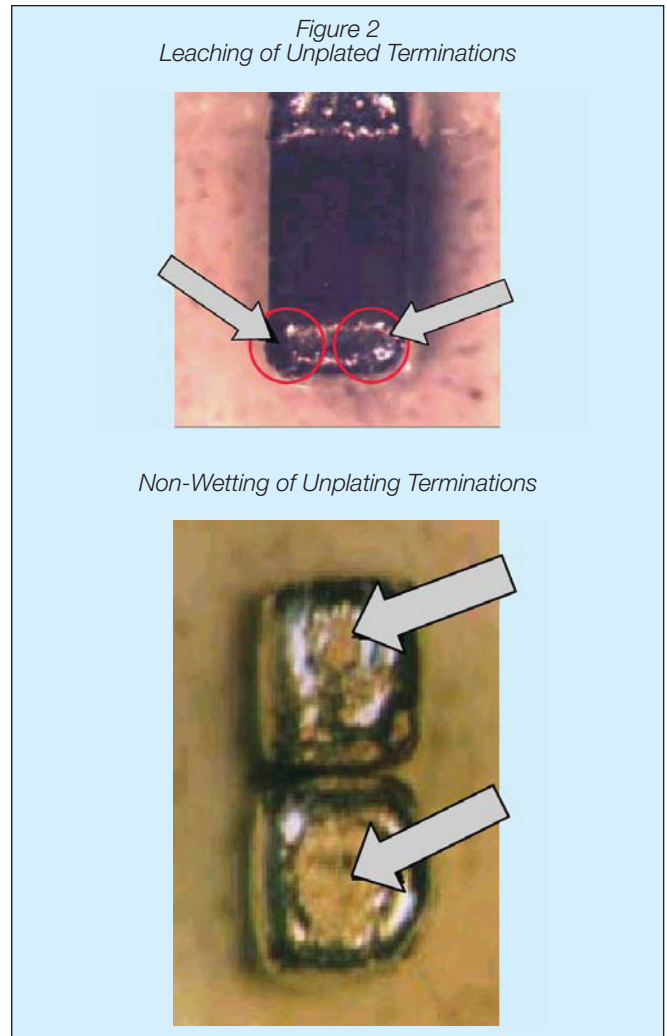



In the plated termination, the base termination layer is still used (it provides contact from the electrodes to the circuitry). On top of the base termination is a layer of nickel. This is the surface to which the solder bonds during assembly. It must be thick enough to stay intact during IR reflow or wave soldering so that the thick film material does not leach away. It must also be thick enough to prevent the inter-metallic layer between the thick film termination and the nickel layer from affecting the solderability.

In order to protect the nickel (i.e., maintain its solderability), a layer of solder is plated on top of the nickel. The solder preserves the solderability of the nickel layer. It must be thick and dense to keep oxygen and water from reaching the nickel layer.

**THE CHALLENGE**

Zinc oxide varistors are semi-conductive in nature – that is what allows them to “turn on” and divert a damaging transient away from sensitive electronic circuitry and safely to ground. This semi-conduction poses a major problem for the manufacturer that wants to plate the terminations – the ceramic plates also! This condition, overplating, must be controlled, as it is cosmetically undesirable and could result in an unwanted path of conduction across the chip.

Early efforts in plating MLVs revolved around limiting the time that the chip was in the plating bath. This helped prevent overplating, but also produced chips with marginal solderability. The photographs in Figure 4 depict the problems that occur when the plated layers are not thick enough.

**THE SOLUTION**

AVX has developed a proprietary process that passivates the ceramic surface of the MLV. This allows us to plate the parts for a longer time without getting the overplate. This results in significantly thicker layers of nickel and alloy plated onto the base termination. These thicker layers translate into bond strengths that are typically twice those of our competitors and parts that pass all measured of solderability (as seen in Figure 5).

AVX: The solution for MLV assembly problems.

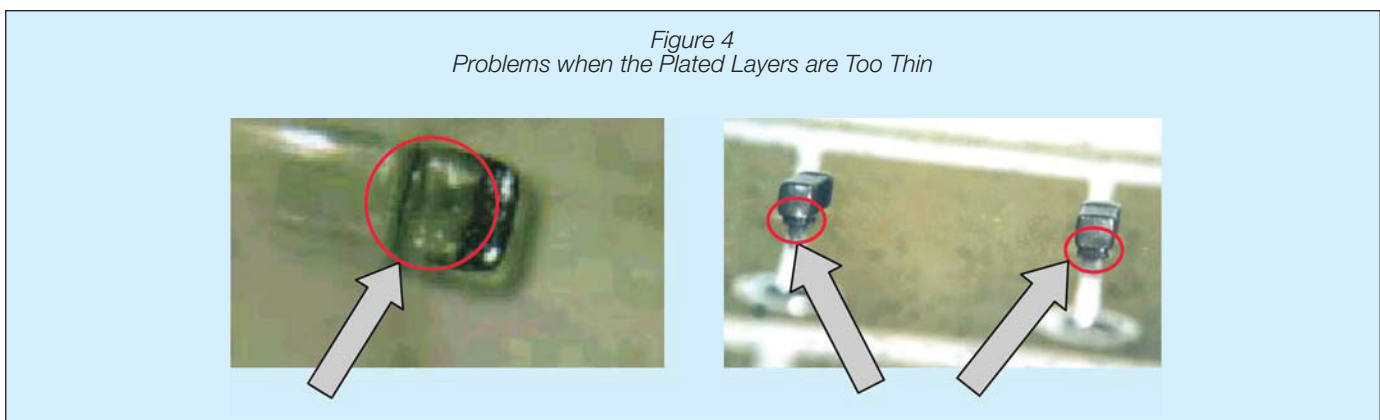
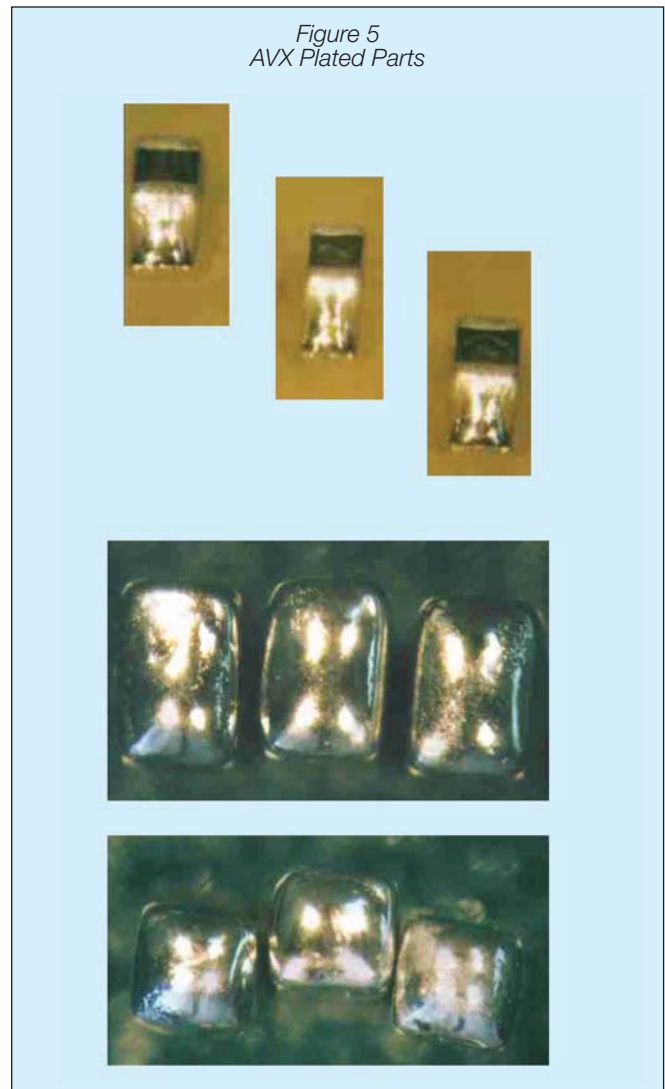



# Packaging

- Chips
- Axial Leads
- Radial Leads

# Paper Carrier Configuration

## 8mm Tape Only

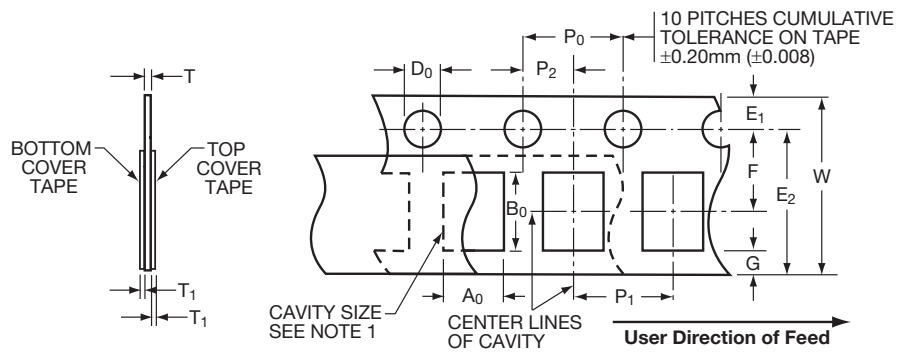

### 8MM PAPER TAPE

### METRIC DIMENSIONS WILL GOVERN

### CONSTANT DIMENSIONS

mm (inches)

Tape Size	D <sub>0</sub>	E	P <sub>0</sub>	P <sub>2</sub>	T <sub>1</sub>	G. Min.	R Min.
8mm	1.50 <sup>+0.10</sup> <sub>-0.04</sub> (0.059 ± 0.004)	1.75 ± 0.10 (0.069 ± 0.004)	4.00 ± 0.10 (0.157 ± 0.004)	2.00 ± 0.05 (0.079 ± 0.002)	0.10 (0.004) Max.	0.75 (0.030) Min.	25.0 (0.984) See Note 2 Min.

### VARIABLE DIMENSIONS

mm (inches)

Tape Size	P <sub>1</sub> See Note 4	E <sub>2</sub> Min.	F	W	A <sub>0</sub> B <sub>0</sub>	T
8mm	4.00 ± 0.10 (0.157 ± 0.004)	6.25 (0.246)	3.50 ± 0.05 (0.138 ± 0.002)	8.00 <sup>+0.30</sup> <sub>-0.10</sub> (0.315 <sup>+0.012</sup> <sub>-0.004</sub> )	See Note 1	1.10mm (0.043) Max. for Paper Base Tape and 1.60mm (0.063) Max. for Non-Paper Base Compositions

#### NOTES:

- The cavity defined by A<sub>0</sub>, B, and T shall be configured to provide sufficient clearance surrounding the component so that:
  - the component does not protrude beyond either surface of the carrier tape;
  - the component can be removed from the cavity in a vertical direction without mechanical restriction after the top cover tape has been removed;
  - rotation of the component is limited to 20° maximum (see Sketches A & B);
  - lateral movement of the component is restricted to 0.5mm maximum (see Sketch C).
- Tape with or without components shall pass around radius "R" without damage.
- Bar code labeling (if required) shall be on the side of the reel opposite the sprocket holes. Refer to EIA-556.
- If P<sub>1</sub> = 2.0mm, the tape may not properly index in all tape feeders.

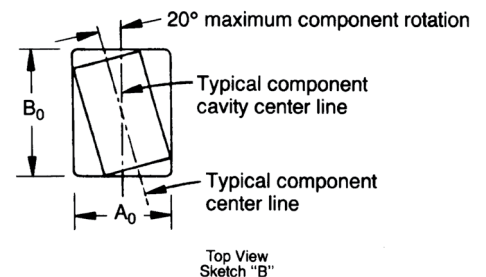
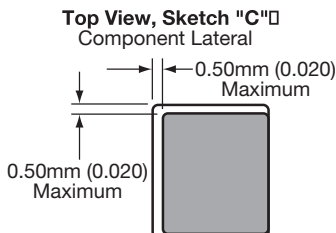
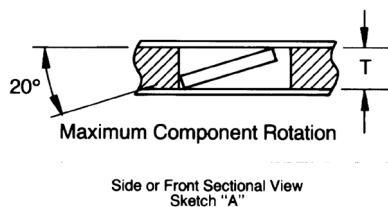

#### Bar Code Labeling Standard

AVX bar code labeling is available and follows latest version of EIA-556

# Embossed Carrier Configuration

## 8 & 12mm Tape Only

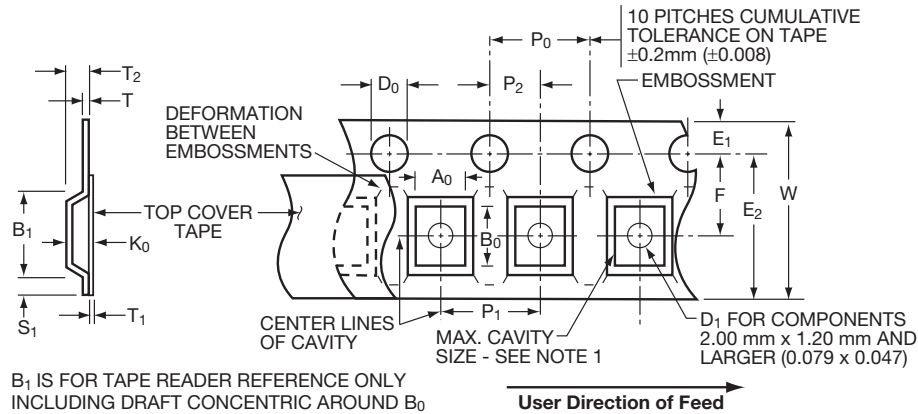

## 8 & 12MM EMBOSSED TAPE METRIC DIMENSIONS WILL GOVERN

### CONSTANT DIMENSIONS

mm (inches)

Tape Size	$D_0$	E	$P_0$	$P_2$	$S_1$ Min.	T Max.	$T_1$
8mm and 12mm	$1.50^{+0.10}_{-0.0}$ ( $0.059^{+0.004}_{-0.0}$ )	$1.75 \pm 0.10$ ( $0.069 \pm 0.004$ )	$4.0 \pm 0.10$ ( $0.157 \pm 0.004$ )	$2.0 \pm 0.05$ ( $0.079 \pm 0.002$ )	0.60 (0.024)	0.60 (0.024)	0.10 (0.004) Max.

### VARIABLE DIMENSIONS

mm (inches)

Tape Size	$B_1$ Max.	$D_1$ Min.	$E_2$ Min.	F	$P_1$ See Note 5	R Min. See Note 2	$T_2$	W Max.	$A_0 B_0 K_0$
8mm	4.35 (0.171)	1.00 (0.039)	6.25 (0.246)	$3.50 \pm 0.05$ ( $0.138 \pm 0.002$ )	$4.00 \pm 0.10$ ( $0.157 \pm 0.004$ )	25.0 (0.984)	2.50 Max. (0.098)	8.30 (0.327)	See Note 1
12mm	8.20 (0.323)	1.50 (0.059)	10.25 (0.404)	$5.50 \pm 0.05$ ( $0.217 \pm 0.002$ )	$4.00 \pm 0.10$ ( $0.157 \pm 0.004$ )	30.0 (1.181)	6.50 Max. (0.256)	12.3 (0.484)	See Note 1

#### NOTES:

- The cavity defined by  $A_0$ ,  $B_0$ , and  $K_0$  shall be configured to provide the following: Surround the component with sufficient clearance such that:
  - the component does not protrude beyond the sealing plane of the cover tape.
  - the component can be removed from the cavity in a vertical direction without mechanical restriction, after the cover tape has been removed.
  - rotation of the component is limited to  $20^\circ$  maximum (see Sketches D & E).
  - lateral movement of the component is restricted to 0.5mm maximum (see Sketch F).

Tape with or without components shall pass around radius "R" without damage. Bar code labeling (if required) shall be on the side of the reel opposite the round sprocket holes. Refer to EIA-556.

$B_1$  dimension is a reference dimension for tape feeder clearance only. If  $P_1 = 2.0\text{mm}$ , the tape may not properly index in all tape feeders.

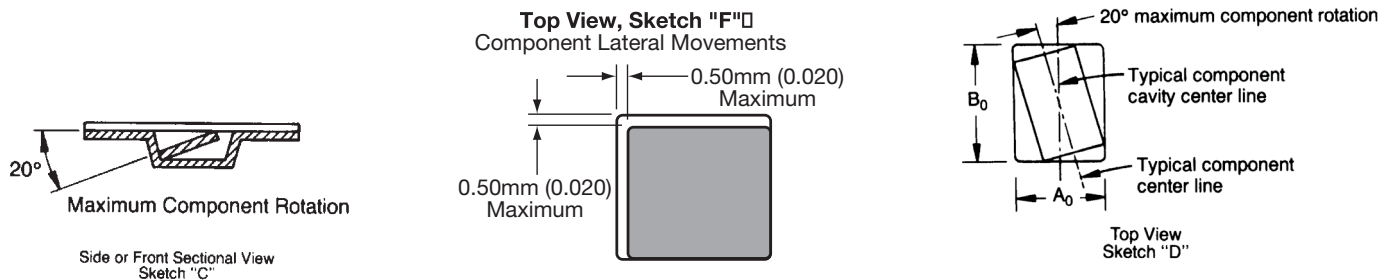

# Packaging of Chip Components

## Automatic Insertion Packaging

### REEL DIMENSIONS

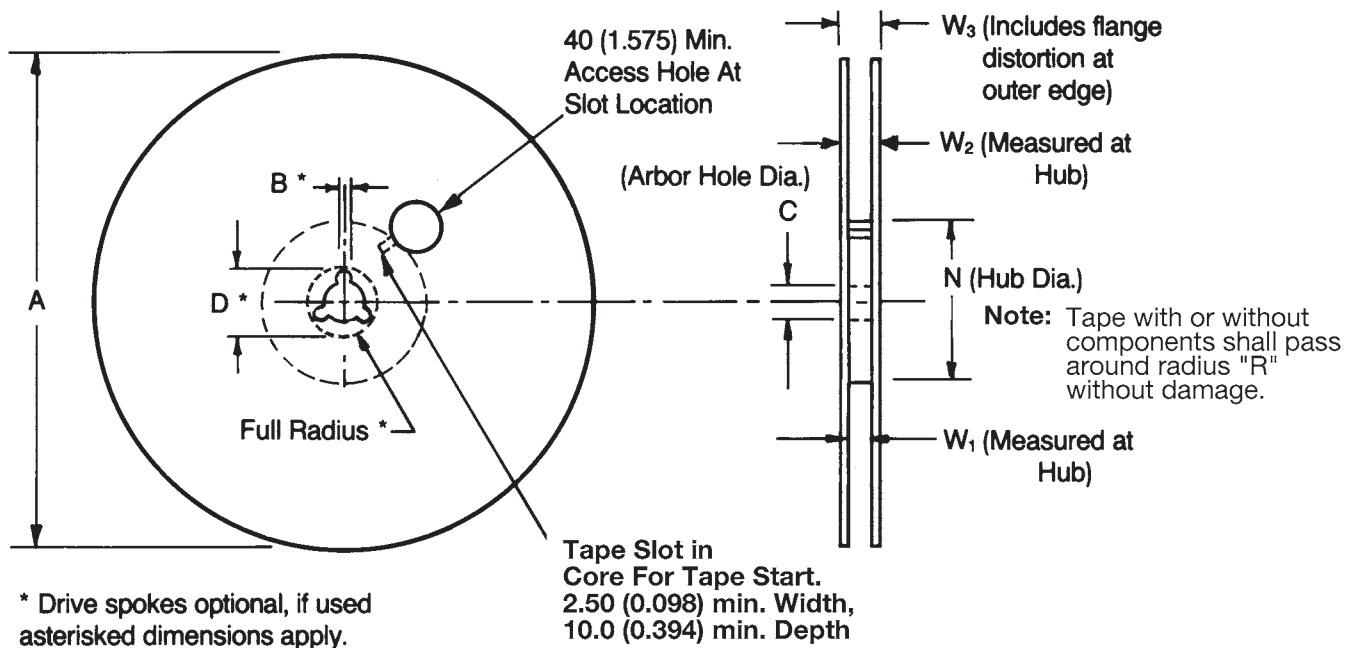

mm (inches)

Tape Size	A Max.	B* Min.	C	D* Min.	N Min.	W1	W2 Max.	W3
8mm	330 (12.992)	1.5 (0.059)	13.0 <sup>+0.50</sup> <sub>-0.20</sub> (0.512 <sup>+0.020</sup> <sub>-0.008</sub> )	20.2 (0.795)	50.0 (1.969)	8.40 <sup>+1.5</sup> <sub>-0.0</sub> (0.331 <sup>+0.059</sup> <sub>-0.0</sub> )	14.4 (0.567)	7.90 Min. (0.311)
12mm						12.4 <sup>+2.0</sup> <sub>-0.0</sub> (0.488 <sup>+0.079</sup> <sub>-0.0</sub> )		11.9 Min. (0.469)
								10.9 Max. (0.429)
								15.4 Max. (0.607)

Metric dimensions will govern.

English measurements rounded and for reference only.

## TRANSGUARD®

CLASS I / RS-296	
A.	5mm ± 0.5mm (0.200" ± 0.020")
B*.	52.4mm ± 1.5mm (2.063" ± 0.059")
C.	6.35mm ± 0.4mm (0.250" ± 0.016")
D1-D2.	1.4mm (0.055" MAX.)
E.	1.2mm (0.047" MAX.)
F.	1.6mm (0.063" MAX.)
G.	356mm (14.00" MAX.)
H.	76mm (3.000")
I.	25.4mm (1.000")
J.	84mm (3.300")
K.	70mm (2.750")

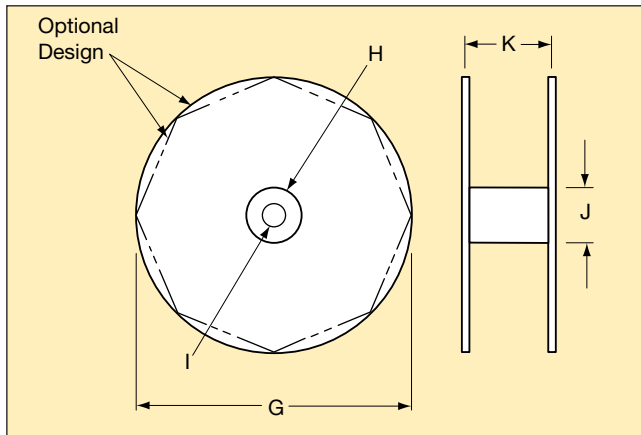
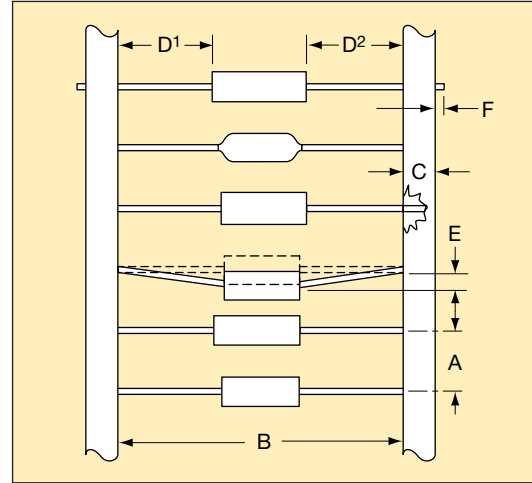

**Leader Tape:** 300mm min. (12")

**Splicing:** Tape Only

**Missing Parts:** 0.25% of component count max.- No consecutive missing parts

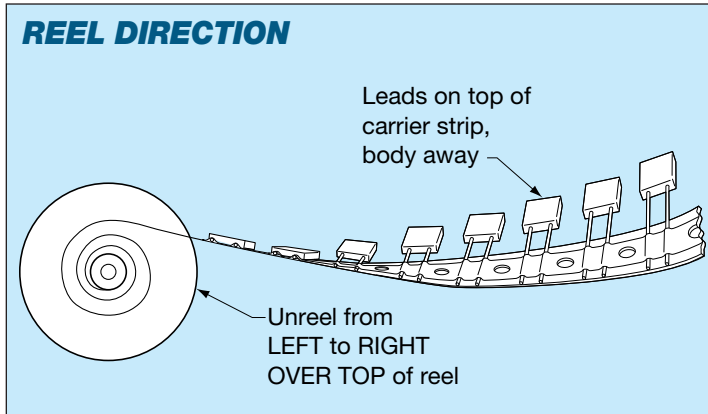

QUANTITY PER REEL	
PART	PCS
VR15, VR20 CG20, CG21	3000

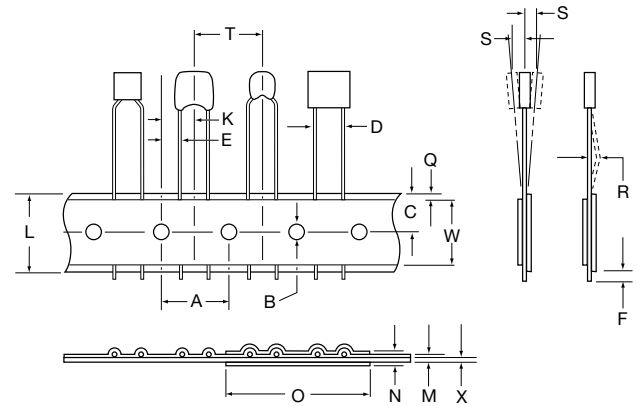
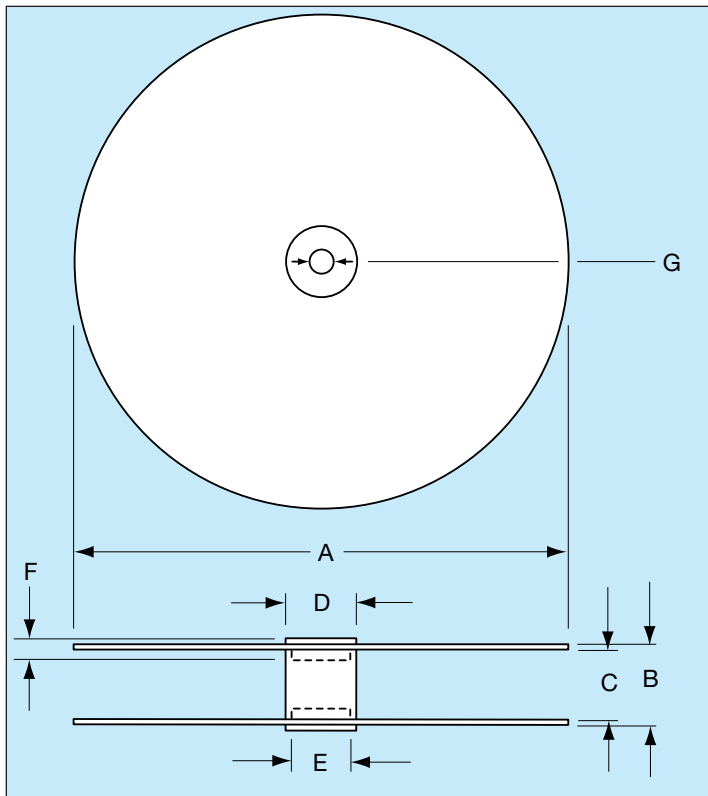

DESCRIPTION	DIMENSIONS (MM)
A - Reel Diameter	304.80 - 355
B - Reel Outside Width	50.80 maximum
C - Reel Inside Width	38.10 - 46.02
D - Core Diameter (O.D.)	102.01 maximum
E - Hub Recess Diameter	86.36 maximum
F - Hub Recess Depth	9.50 minimum
G - Arbor Hole Diameter	25.40 - 30.48

DESCRIPTION	DIMENSIONS (MM)
A. Feed Hole Pitch	12.70 ± .20
B. Feed Hole Diameter	3.99 ± .20
C. Feed Hole Location	9.02 ± .51
D. Component Lead Spacing	5.00 <sup>+0.79</sup> <sub>-.20</sub> or 2.54 <sup>+0.79</sup> <sub>-.20</sub>
E. Component Lead Location	3.81 ± .51 or 5.00 ± .51 for 2.54 lead spacing
F. Component Lead Protrusion (edge of carrier to cut end of lead)	2.00 maximum
K. Component Body Location	6.35 ± .41
L. Carrier Tape Width	18.01 <sup>+1.02</sup> <sub>-.51</sub>
M. Carrier Tape Assembly Thickness	.71 ± .20
N. Carrier Tape Spliced Thickness	1.42 maximum
O. Carrier Tape Spliced Length	50.80 - 88.90
Q. Adhesive Tape Border	3.00 maximum
R. Component Bent Leads (either direction)	.79 maximum
S. Component Misalignment	.99 maximum
T. Component Pitch	12.70 ± .99
W. Adhesive Tape Width	5.00 minimum
X. Carrier Tape Thickness	.51 ± .10
Y. Cumulative Pitch over 20 Pitches	254 ± 2.00

**FOLLOW US:**     

VISIT US AT [WWW.AVX.COM](http://WWW.AVX.COM) 

**North America**

Tel: +1 864-967-2150

**Europe**

Tel: +44 1276-697000

**Asia**

Tel: +65 6286-7555

**Central America**

Tel: +55 11-46881960

**Japan**

Tel: +81 740-321250