

Powered by

# Markt & Technik

DIE UNABHÄNGIGE WOCHENZEITUNG FÜR ELEKTRONIK

2022 | E

- *Know-how*
- *Application*
- *Future Mobility*
- *Rutronik Excellence*
- *Passive Components*

# RUTRONIKER

# YAGEO

Group

**KEMET** **YAGEO**  **Pulse**

## YAGEO GROUP AUTOMOTIVE SOLUTIONS

- Anti-Sulfurated Chip Resistors • Shunt Metal Current Sensors • Metal Composite Power Inductors
- Circuit Protection Components • Automotive High Frequency MLCC • BMS Transformers • DC Link E-Cap
- Polymer Tantalum • Pulse and Snubber • Aluminium Hybrid • Solid Polymer • DC Link Film

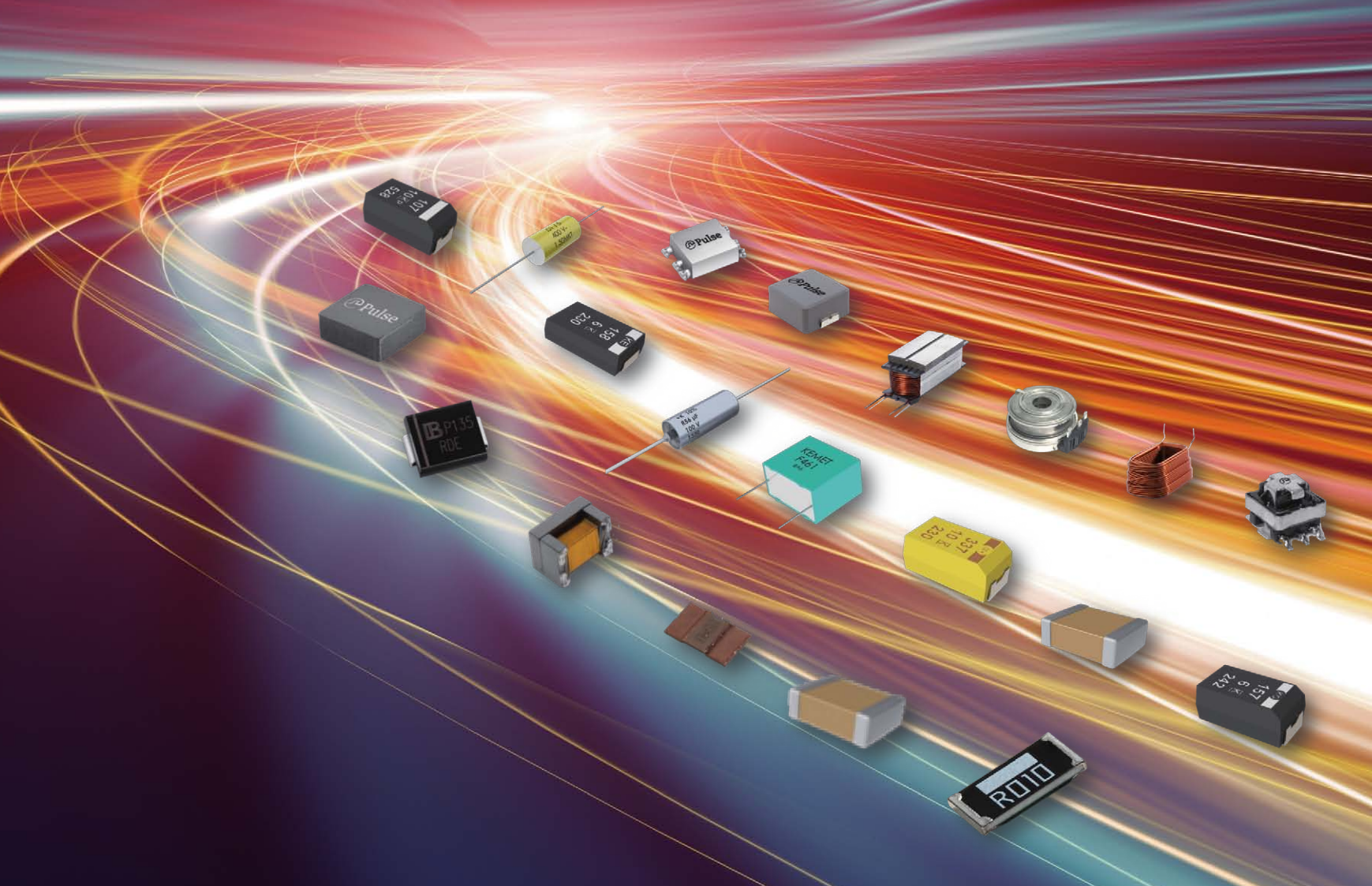



Andreas Mangler

## A helping hand in troubled times

Dear Reader,

Current developments in the electronics market prove that there are many micro- and macroeconomic factors that severely impact value and supply chains in a variety of ways. Innovations and applications based around various trends, such as industrial AI, safety and security, eMobility, and connectivity with wireless and embedded solutions, continue and are positive. Yet there remain challenges associated with rising energy prices that are rapidly speeding up developments in the field of renewable energies. Added to this are shortages in some product areas for semiconductors, which have lasted for more than a year now, and the related disruptions to supplies, while the demand for semiconductors and electronic components as a whole remains stable.

Read the interview with my colleague Jan Stoll and myself to discover what we have to say about some of the latest industry measures and proposals, such as the EU Chips Act. We show, in particular, the opportunities and challenges that Europe faces through the establishment of semiconductor fabs. Moreover, we take a closer look at the high store inventory levels of some players in the value chain and how this stockpiling of highly priced semiconductors could soon cause cash flow problems for certain companies. Read more about the role of various players in the electronics supply chain in response to these current developments from page 71.

The factors and developments outlined in the interview introduce yet more dynamism to the global electronics market. In this respect, the combination of global standardization and regional adaptation in terms of product and sales strategies is essential. Our CEO, Thomas Rudel, explains in another interview how Rutronik initiates and implements appropriate measures. From page 24, he discusses expansion of the executive management team, and the regionalization strategy launched this year. This strategy focuses on global networking while ensuring even greater customization to meet local market and customer needs.

Thanks to our Rutronik System Solutions, we are also able to support our customers from start to finish and beyond, since we realize that many research and development capacities remain unexplored within the industry due to a lack of time and resources. We therefore work together with research institutions and universities to develop solutions as proof-of-concepts in order to export innovation potential to industrial markets and to reduce the time to market for our customers. This is how Rutronik bridges the gap between science and engineering. Discover more about our Rutronik System Solutions and the first patented solutions we are developing under the umbrella of our Rutronik IP activities AI<sup>3</sup> (“A Triple I”) on page 53.

As always, you can look forward to a wealth of articles on current and trend-setting technologies, applications, and components. On behalf of the entire Rutronik team, I hope you enjoy reading the fascinating features with valuable incentives and suggestions for your work.

Sincerely,

**Andreas Mangler**

Director Strategic Marketing

and Member of the Extended Executive Board at Rutronik

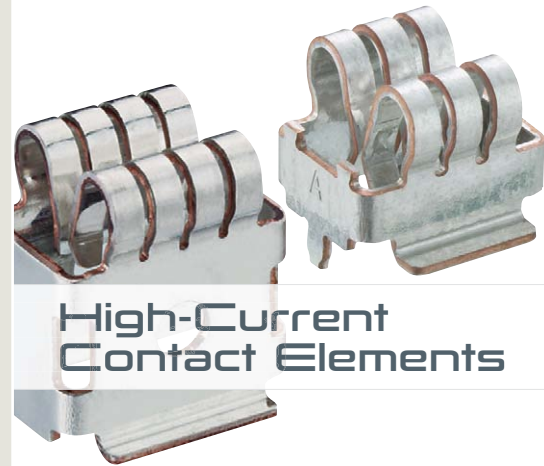

High-Current Contact Elements



versatile application possibilities in compact control units and on-board charging modules

mating with contact tab, top or bottom entry

for SMT soldering or welding

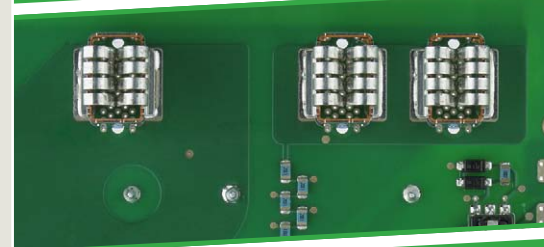

from 60 A up to 80 A

Editorial	3
-----------	---

## ● APPLICATION

Developing devices to EU Ecodesign Directive 2009/125/EC: Energy-efficient components support climate protection	6
The ideal logic family for every application: From a well-connected family	10
Intelligent display modules: A smart path to a contemporary user interface	14
Development tools for embedded software: Flexible workflow for more efficient development	18
Cordless power tools: Considering all trends and requirements in the design	22

## ● RUTRONIK EXCELLENCE



Interview with Rutronik CEO Thomas Rudel: "Strengthening the European market"	24
---	----

Rutronik System Solutions: Added value for the entire value chain	53
Taking a look at the electronics supply chain: "The market has to become more resilient"	71

## ● KNOW-HOW

Partial discharge testing: Testing the quality of low power transformers	26
Why is F-RAM important for data acquisition?: Storing data efficiently and securely	29
New memory technology for innovative IoT applications: The golden mean	32
Design-in of eMMCs in various environments: Long live the memory!	36
Wi-Fi 6 and Wi-Fi 6E – the latest Wi-Fi standards: Fit for current and future requirements	39
Bluetooth LE Audio: Better listening experience	42
Display technology: ePaper displays stepping into a new color dimension	48
Aid with selecting the right EEPROMs: Connected to the memory correctly	50

## ● PASSIVE COMPONENTS

Curse and blessing of MLCC version diversity: Interesting facts for more supply security	56
Tantalum polymer capacitors: Effective decoupling	58
Vibration-resistant electrolytic capacitors: Solid as a rock	62
THB grades for film capacitors: Robust and durable	64
Quartz crystals, oscillators and real-time clocks: Delivery capacity thanks to own quartz crystal production	66
Ethernet transformers: High quality due to automated production	69

## ● FUTURE MOBILITY

Components for onboard chargers: What is actually needed to ensure efficient charging of electric vehicles?	74
Charging port for electric vehicles: Why charging is not just Refueling 2.0	78
DC/DC converters: Electromobility in harsh environments	80
Greater functional safety in cars: Mastering ESD for interference-free data transmission	82
Smart eFuse for automotive applications: More safety for 48 V electrical system architectures	84
Automotive-qualified MEMS microphone: The car is all ears	86
Elektronik load protection with the Infineon PROFET Load Guard: Guardians of automated mobility	88

Publishing details	68
List of advertisers	68



# UFS

## High Performance Storage

For applications demanding for superior interface performance, KIOXIA is offering a broad line-up of new UFS Memory products. Utilizing a full duplex serial high-speed interface, it is compliant with the latest UFS Version 3.1 and 4.0. In combination with the embedded memory management, it offers a highly efficient and excellent performing storage solution. UFS memory enables next generation mobile devices to take full advantage of the connectivity benefits of 5G, leading to faster downloads and reduced lag time – and improved user experience.

### SPECIFICATIONS

FEATURES	UFS – UNIVERSAL FLASH STORAGE
Density	128 GB – 1 TB
Technology	BiCS FLASH™
JEDEC Version	3.1 and 4.0
Temperature	-25° C to 85° C
Package	153 ball FBGA (11.5 x 13 mm and 11 x 13 mm)

### COMPARING THE PERFORMANCE:

■ e-MMC   ■ UFS

#### Sequential Read

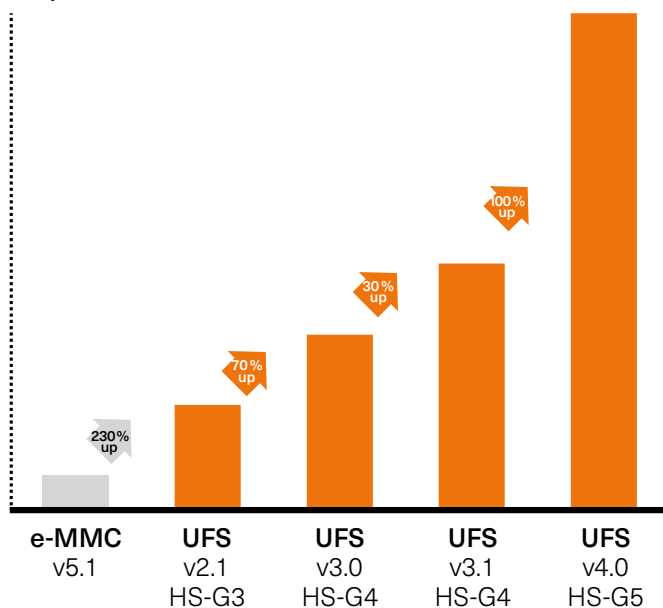

### CAPACITIES:



### KEY FEATURES:

- 128 GB – 1 TB
- BiCS FLASH™
- 3D-TLC technology
- UFS Version 3.1 and 4.0
- Integrated memory management:
  - Error correction code
  - Bad block management
  - Wear-levelling
  - Garbage collection
- WriteBooster: Enables significantly faster write speeds
- Standard temperature range up to 85°C
- FBGA package
- High Speed Serial interface

### ADVANTAGES

- High speed interface up to 1160 MB/sec / 2320 MB/sec / 4640 MB/sec
- Managed memory
- Package, interface, features, commands, etc. are standard
- Utilises high quality KIOXIA BiCS FLASH™ memory in combination with a KIOXIA origin developed controller

### APPLICATIONS:

- Consumer Electronics
- Multimedia Applications
- Industrial Applications
- Smart Applications



Developing devices to EU Ecodesign Directive 2009/125/EC

# Energy-efficient components support climate protection

*Needless to say, climate protection is something that concerns us all. But climate objectives can only be achieved with even more efficient electronic devices. The EU has set out the minimum requirements for energy-related products in its Ecodesign Directive. Innovative components help to meet them.*

BY EMILIA MANCE,  
CORPORATE PRODUCT SALES MANAGER  
STANDARD PRODUCTS  
AT RUTRONIK

**R**oughly one-quarter of the total power consumption in Germany in 2018 was attributable to private households. At 129 terawatt hours, the figure was still 7.2% less than 2008 (source: German Environment Agency (UBA)). This decline is due in part to various consumer labels such as the Blue Angel eco-label and the EU energy label with energy efficiency classes on a scale from A+++ to G. Further, the energy efficiency standards set out in the EU Ecodesign Directive 2009/125/EC contribute to energy savings.

The aim of the Ecodesign Directive is to improve the environmental performance of energy-related products throughout their whole life cycle. To this end, it stipulates mandatory requirements for devices that have a signifi-

cant environmental impact "in accordance with Community environmental priorities, such as those set out in Decision No. 1600/2002/EC." In addition, the devices must demonstrate significant potential for improvement in terms of their impact on the environment without entailing excessive costs, and their annual sales in the EU market should exceed 200,000 units.

Household appliances such as refrigerators and freezers, dishwashers and washing machines, electric hot plates, microwave ovens and electric ovens, smart home devices, and consumer electronics, but also PCs, electric motors, and welding equipment are thus affected.

There is also the EU Standby Regulation, which spells out the ecodesign requirements for the electric power consumption of electrical and electronic household appliances and office equipment in standby and off modes. For example, according to the said directive, the power consumption of large household appliances, such as hot plates, ovens, or even television sets, must not in any condition exceed 0.5 W in standby mode and off mode, and 1 W when displaying information or status.

With the aid of appropriate components, Rutronik supports its customers in developing energy-efficient devices that meet these requirements. A few examples:

*LDO voltage regulator with switch-off pin*

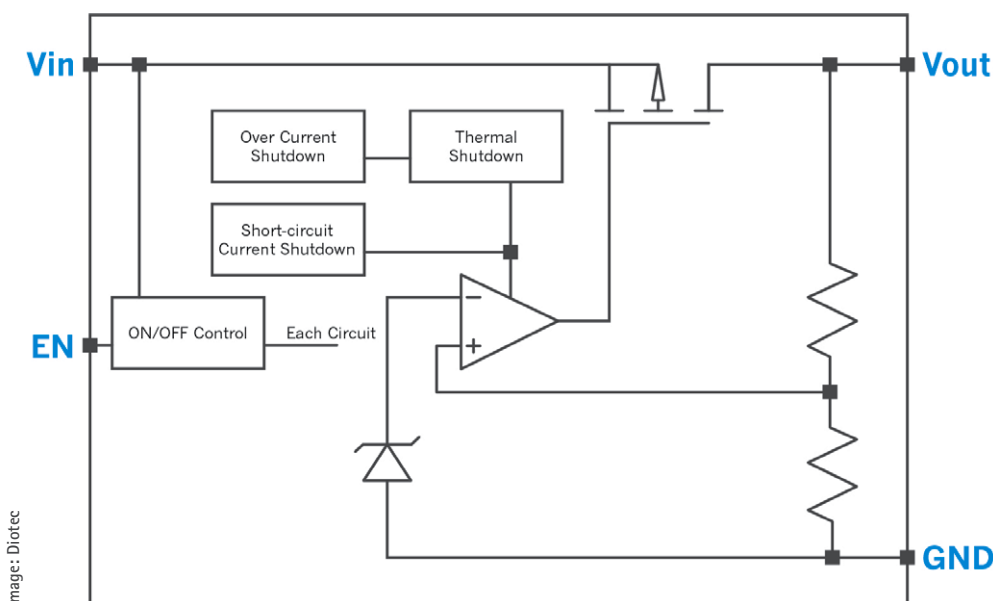

Image: Diotec

Figure 1: Thanks to its enable function, Diotec's LDI8119EN LDO regulator uses an external signal to switch the system on and off.

A low dropout regulator (LDO regulator) is a linear DC voltage regulator that can regulate

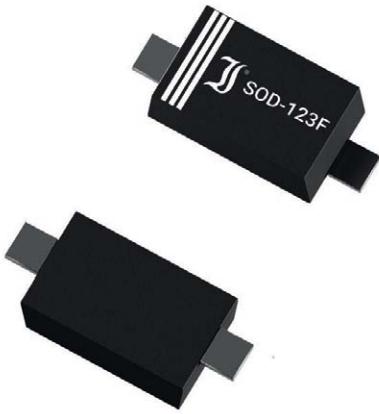

Figure 2: The MM1Z4711 Zener diode from Diotec operates at just 50  $\mu\text{A}$ , thus helping to reduce the overall power consumption of devices.

the output voltage even when the supply voltage hardly differs from the output voltage. An LDO regulator works very efficiently as it can be switched off when not required, thus helping to save power. This makes it ideal for devices that are frequently in standby mode and for applications whose output voltage needs to be regulated only slightly below the input voltage.

Compared to other clocked DC/DC regulators, LDO regulators have a number of other advantages to offer. The linear operation of the LDO regulators does away with the need for switched transistors, which would otherwise generate noise and interference. They do not require inductors and transformers, thereby allowing for smaller devices and less complex designs. However, unlike switching regulators, they do dissipate power or heat via the control unit.

When using switching regulators, an LDO regulator is often added to the output as an ac-

tive filter. Especially for applications in the field of measurement and sensor technology, low-noise and interference-free power supplies are essential, e.g. for high-resolution ADCs and DACs or precision operational amplifiers. This is because, on their own, they are hardly able to achieve the low output ripple necessary for a strict noise specification. In this case, LDO regulators with a high power supply rejection ratio (PSRR) between the input and output side in accordance with the switching frequency of the upstream switching regulator are recommended.

PSRR is one of the key parameters affecting the behavior of LDO regulators. It indicates the extent to which the LDO regulator is able to reduce fluctuations on the output side caused by the variable input voltage. The following applies:

$$\text{PSRR} = 20 \log_{10} \cdot V_{in}/V_{out}$$

Other important parameters are the dropout voltage and the quiescent current. The dropout voltage is the difference between the input and output voltages required for internal regulation at the exact point where the output voltage can no longer be regulated when the input voltage continues to fall. The quiescent current of an LDO regulator is composed of its feedback and drive current. The lower the quiescent current and dropout voltage, the greater the efficiency of the LDO regulator.

#### *Boosting battery life with LDO regulators*

An LDO regulator can be a very effective means of increasing energy efficiency in a

battery system by minimizing power consumption in standby mode. The new LDI8119EN voltage regulator from Diotec (Fig. 1), which can switch off the system in standby mode via an enable function, is ideally suited for this purpose. The enable input (EN) uses an external signal to switch the battery system on and off. If the regulator is deactivated, the internal band-gap reference continues to run, thus allowing fast switch-on times.

If the LDO regulator is switched off, the input current is usually limited to 1  $\mu\text{A}$ . This shutdown current should not be confused with the quiescent current, i.e. the current consumed by the switched-on device with no load. Both shutdown current and quiescent current are key parameters for the battery life. The following formula is used to calculate the power loss or power dissipation (PD):

$$\text{PD} = (V_{in} - V_{out}) \cdot I_{out} + (V_{in} \cdot I_Q)$$

With no load on the LDO regulator, i.e. the output current is 0 A, the quiescent current ( $I_Q$ ) is the decisive parameter for power dissipation. It is responsible for almost half of the total power dissipation.

This means that in applications where the device is predominantly operated in idle mode, the quiescent current plays a key role and must be taken into account during the design process.

LDI8119EN from Diotec has a particularly low quiescent current of just 60  $\mu\text{A}$ . With a shutdown current of 0.4  $\mu\text{A}$  to 1.0  $\mu\text{A}$ , it is well-suited to all battery management applications. This simple component can significantly increase the efficiency of the battery system and boost battery life.

Advertisement

**C&K** NOW PART OF  
**Littelfuse**



## Leading Innovation & Quality

New Thinking, New Design, New Products

### THB

- Miniature thumbstick switch

### PLP16

- LED sealed pushbutton switch

### TF3

- Miniature snap-acting switch

<https://www.ckswitches.com>



Figure 3: Each diode technology has its specific strengths and weaknesses; and it is not possible to achieve the ideal state with any of them.

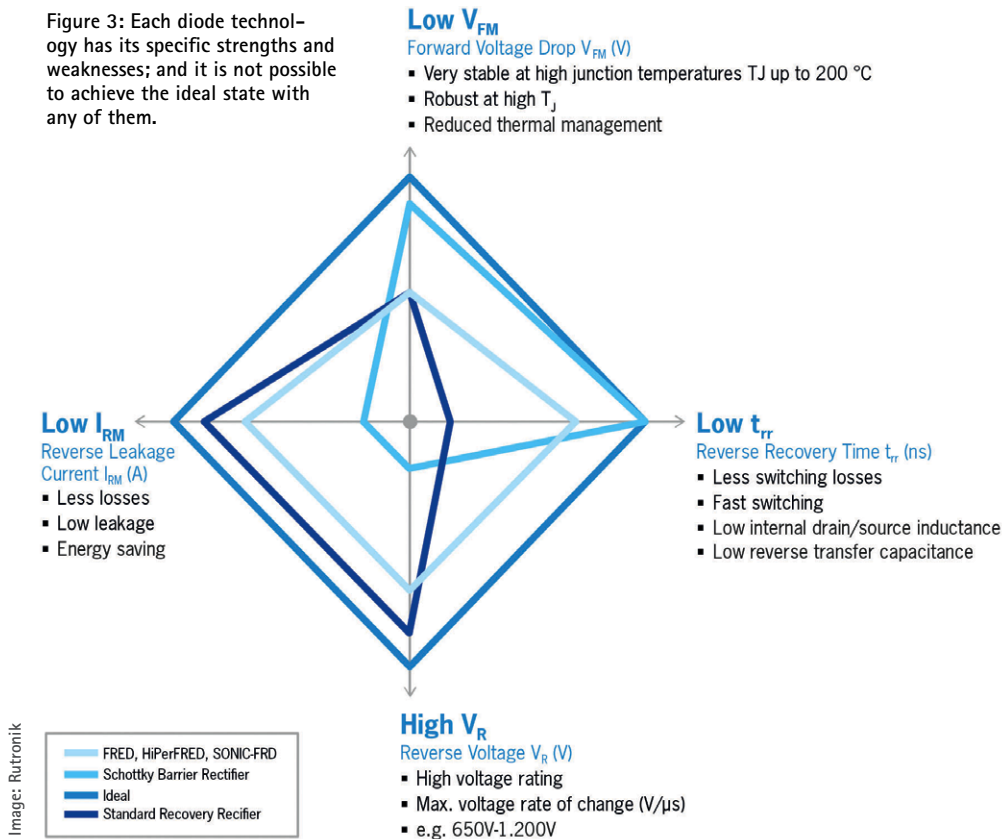

*Zener diode with a test current of just 50  $\mu$ A*

Zener diodes typically operate in the low mA range, thereby consuming several milliwatts of power. However, this may be too much to comply with the Ecodesign Directive. In contrast, the MMS1ZXX and MMSZXX diodes from Diotec and Panjit operate at just 50  $\mu$ A, thus helping to reduce overall power consumption (Fig. 2). They are usually used for voltage stabilization and regulation. In the standard version, the tolerance of the Z-voltage is graded according to the international series E24 ( $\pm 5\%$ ). Other tolerances and higher operating voltages are available on request. The maximum power dissipation of the diodes is 500 mW. They also have a low reverse current and a flat design.

*Fast rectifier diodes for more energy efficiency*

In the power electronics market, rectifier diodes have a decisive influence on the performance of the overall system, e.g. in PFC circuitry (power factor correction) and applications such as motor controllers, inverters, as well as bridge and DC/DC converters. When looking at which components produce the

most heat when operating these systems, the rectifier diodes are usually top of the list.

However, selecting the ideal rectifier diode is not an easy task. Since each diode technology has its advantages and disadvantages, and each application needs to meet individual requirements, some of which contradict each other (Fig. 3). To be able to offer the ideal diode for every application, Rutronik has access to a broad product portfolio of diodes with varying technologies.

When it comes to energy efficiency, the ES1G Superfast Efficient rectifier diode, e.g. from the suppliers Panjit, Diotec, and Diodes, should be first choice. It is suitable for circuitry that operate at high frequencies, such as switched-mode power supplies. Beside conduction losses, there are also switching losses proportional to the switching time. Since total losses are the sum of conduction and switching losses, both of these parameters must be taken into account when selecting a suitable diode. For circuitry operating at low kHz frequency and with current ratings of a few amperes or more, a fast diode with low forward voltage is recommended. For circuitry operating up to a few 100 kHz, the focus is on a diode with a short switching time. Ideally, the diode combines low forward voltage and short switching time, just like ES1G. This helps to significantly re-

duce the power dissipation and thus the system's power consumption.

*Schottky diode with low reverse current and flux voltage*

For appliances that are constantly in use, such as hot plates or microwave ovens, the key is to save every milliwatt of power to meet the requirements of the Ecodesign Directive. Boasting a reverse current below the industry standard and a low forward voltage, Diotec's SK34SMA L217 15MQ040N Schottky diode ticks all the boxes. It is also responsible for rectification of the power supply. Furthermore, it is also perfect as an output rectifier for the wireless charging of battery-powered devices. Due to its lower leakage currents, it additionally enables longer standby periods.

How does it achieve this? Until now, forward voltage and residual reverse current were considered the main parameters for Schottky diodes. They are interrelated: If the forward voltage is reduced, the residual reverse current increases and vice versa.

There is, however, still a prevailing assumption that the forward voltage is the main contributor to power dissipation, while the residual reverse current is of lesser importance. But that is not true in every case. An example: If the output voltage of a boost converter is much greater than the input voltage, the duty cycle will be very long. The longer the cycle, the longer the Schottky diode remains reverse-biased and the greater the reverse losses. Therefore, when dimensioning and selecting the appropriate Schottky diodes, it is essential to analyze the operating conditions in the application or task at hand in detail in advance. The overall losses are, therefore, the sum of the switching, conduction, and reverse losses.

*Summary*

The examples show that innovative components can contribute significantly to the development of more energy-efficient devices that meet the requirements of the Ecodesign Directive. And they thus make an active contribution to climate protection. ■



# WE CONNECT

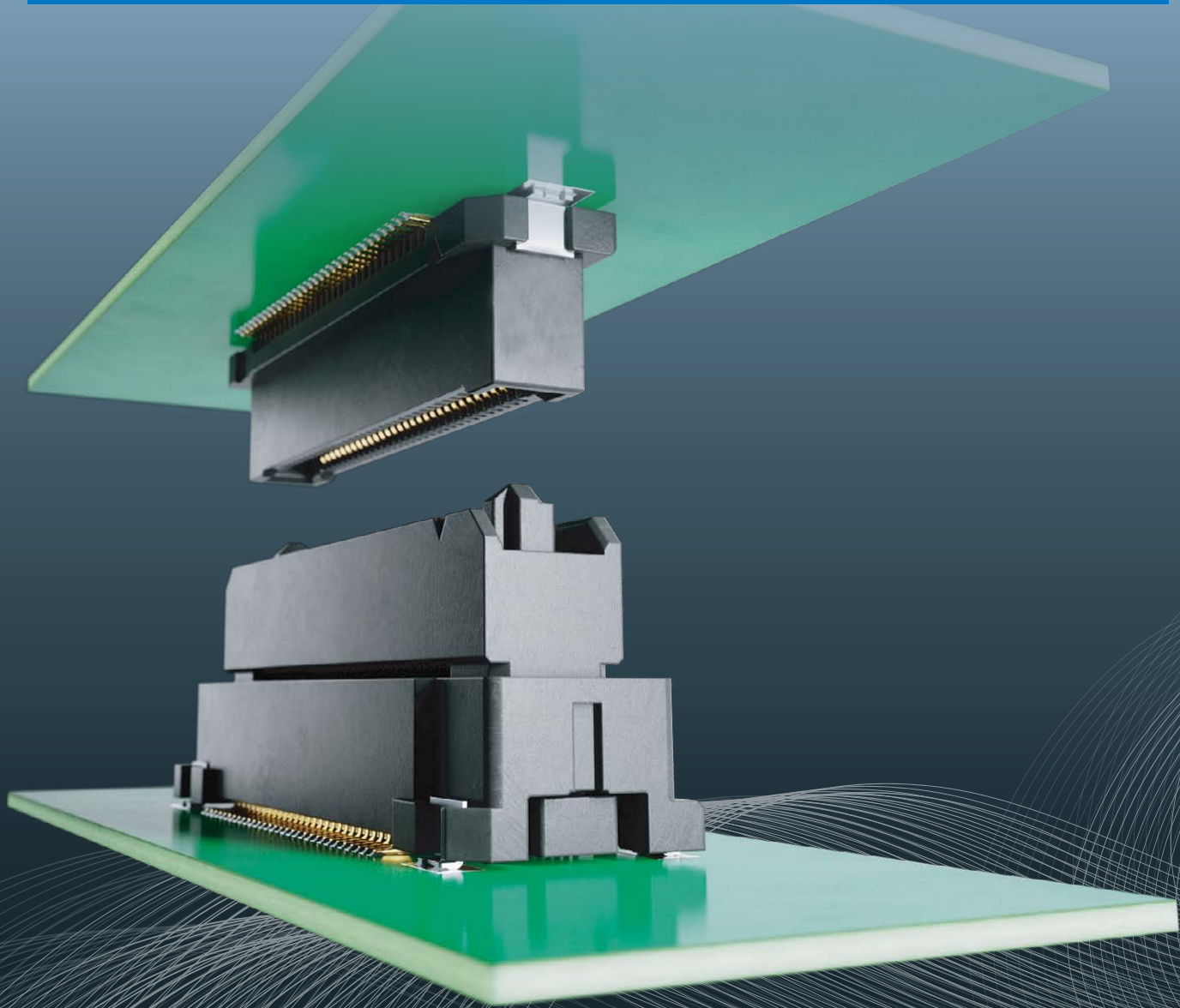

## THE MA01 SERIES BtB HIGH SPEED TRANSMISSION FLOATING CONNECTORS FOR AUTOMOTIVE

- Perfect alignment
- High speed data transmission
- High contact reliability
- Multiple mounting options
- Tailored to automotive market requirements (-40 °C to +125 °C)



Technology to Inspire Innovation

**JAE**

The ideal logic family for every application

# From a well-connected family

*There are many logic families, and each has its own special features. And finding the most suitable one for the application at hand can be challenging. An overview can help to make the right individual decision.*

BY THOMAS BOLZ, CORPORATE PRODUCT  
MANAGER STANDARD PRODUCTS  
AT RUTRONIK

**F**or the application to work properly, logic operations, voltage ranges, or logic levels must be stored and signals transferred between digital ICs. The simplest solution is the use of logic modules. It ensures that a simulated digital circuit is transferred to the application.

Each logic family has its specific characteristics. The modules differ in terms of their level and supply voltage, signal/noise ratio, gate propagation time, maximum frequency, power consumption, as well as fan-in and fan-out.

*Two families determine the market*

The market is dominated by two major families – each with various subfamilies. First, the transistor-transistor logic (TTL) gate (logic based on bipolar transistors), and second, modules based on complementary metal oxide semiconductor (CMOS) technology, i.e. field-effect transistors with opposite polarity.

The members of the TTL family consist of a set of logic gates built from transistors, diodes, and resistors. They cover virtually all

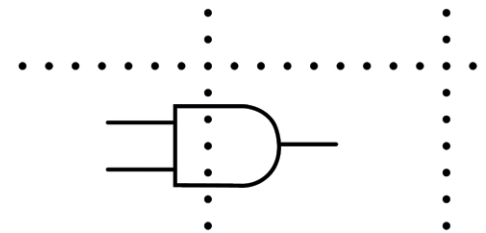

Figure 1: Standard symbol for logic gates with a wide range of variants in terms of package and number of channels.

conceivable applications with low and medium integration level circuits. Signal input and output coupling is done via transistors. TTL gates are characterized by short switching times and a relatively high output current, which allows smaller loads to be controlled directly. The driver possibility of a high output current is simultaneously accompanied by high quiescent current consumption and thus also by a relatively high power requirement. This in turn forces large chip areas to dissipate the resulting heat loss and limits the integration density. Examples of TTL families are listed in Table 1.

Logics based on CMOS technology are now the most widely used ones due to their various advantages, such as lower power consumption and less noise. They are based on the combination of an N-channel MOSFET with the complementary P-channel MOSFET (Fig. 2).

In each switching state, one of the two MOSFETs is blocked and the quiescent current is approximately zero; only insulation and junction leakage currents of a few nanoamperes flow. Further, the circuit is mostly free of parasitic resistors, meaning CMOS gates do

Family	Properties
74 xx	Standard TTL
74 H xx	High-Speed TTL
74 ALS xx	Advanced Low-Power Schottky TTL, fast and energy saving
74 AS xx	Advanced Schottky TTL, the fastest TTL family available
74 F xx	Fast TTL, very fast TTL family
74 L xx	Low-Power TTL
74 LS xx	Low-Power Schottky TTL (replacing 74 and 74L), fast and energy saving
74 S xx	Schottky TTL, fast standard TTL series

Table 1: The TTL families and their properties

Images: Rutronik

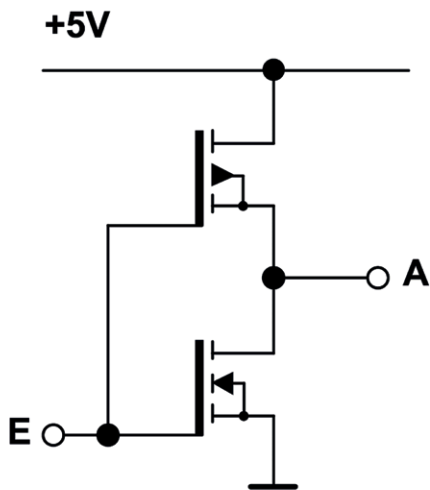

Figure 2: The basic module of all CMOS gates is a stage consisting of two complementary MOSFETs. This represents the simplest form of an inverter.

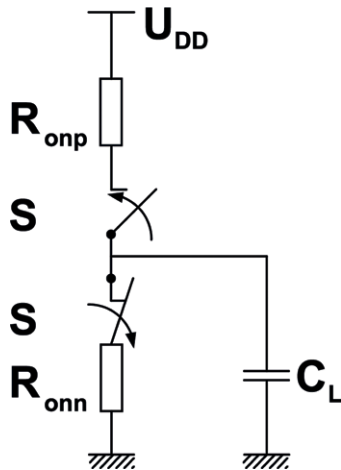

Figure 3: Modeling the power loss of a CMOS gate.

not consume power in the static state. However, the average current consumption of the CMOS gate depends on the switching frequency and increases with the frequency: The predominant consumption occurs during charging and discharging of the transistor capacitances  $C_T$ . When charging, energy is stored, and at the same time the same amount is converted into heat in the charging FET. When discharging, the energy stored in the capacitor is converted into heat in the discharging FET. In a low-high-low cycle, the energy is thus converted into heat. This results in the following power loss:

$$P_V = W/t = W \cdot f = C_T \cdot V_{DD}^2 \cdot f$$

Examples of CMOS families are listed in Table 2.

Family	Properties
74 AC	Advanced CMOS
74 ACT	AC with TTL-compatible inputs
74 HC	High-Speed CMOS
74 HCT	HC with TTL-compatible inputs
74 AHC	Advanced High-Speed CMOS
74 AHCT	AHC with TTL-compatible inputs
74 VHC	Very-High-Speed CMOS
74 VHCT	VHC with TTL-compatible inputs
74 LV	Low-Voltage CMOS
74 LVC	Low-Voltage CMOS ( $V_{CC}$ : 1.65 to 3.60 V, inputs accept up to 5.5 V even at lower $V_{CC}$ )
74 LVX	Low-Voltage CMOS ( $V_{CC}$ : 2.00 to 3.60 V, inputs accept up to 5.5 V even at lower $V_{CC}$ )

Table 2: The CMOS families and their properties

### Levels with TTL and CMOS technology

In a logic gate, the voltage ranges for controlling the output signals are narrower than those for the input signals. When several basic circuits are interconnected, interference signals and noise do not cause the overall circuit to behave erroneously within certain limits. The non-overlapping areas between input and output (or high and low levels) are referred to as signal/noise ratios  $S_H$  and  $S_L$ .

A TTL input detects a logic 0 between 0 and 0.8 V and a logic 1 from 2 to 5 V over the entire supply voltage range. The voltage range between 0.8 and 2 V is a prohibited zone. A signal applied in this range for a long period of time can cause the gate to oscillate and trigger a malfunction. At the output, the levels for 1 are between 2.4 and 5 V, and the 0 levels are between 0 and 0.4 V (Fig. 4, top).

With a 5 V supply voltage, a CMOS gate detects a logic 0 level of between 0 V and 1.5 V at the input and a logic 1 level of between 3.5 and 5 V. At the output, the values are correspondingly 0 to 0.5 V for logic 0 and 4.5 to 5 V for logic 1.

If a voltage of 5 V is applied, the signal/noise ratios for CMOS are already greater than for TTL (Fig. 4). Since the levels

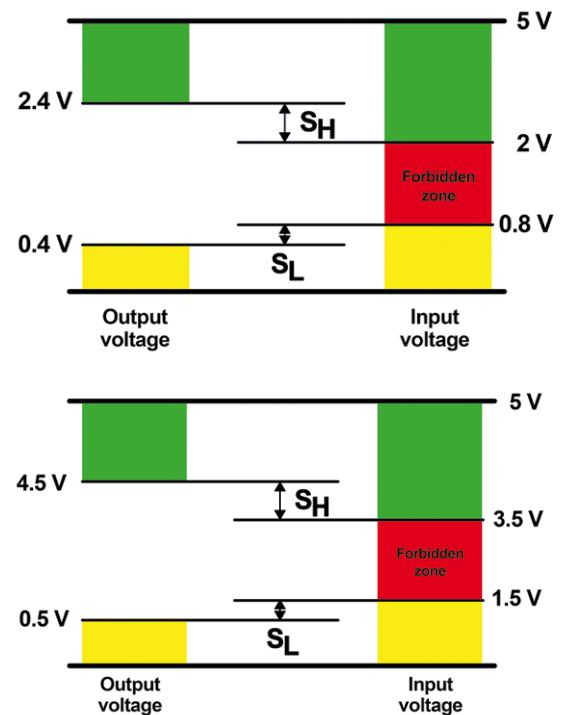

Figure 4: TTL level (top) with  $S_H$  or  $S_L = 0.4$  V compared to CMOS level with  $S_H$  or  $S_L = 1$  V at 5 V (bottom).

depend on the operating voltage for CMOS – the following applies as a rule of thumb:  $U_{ih} = 0.7 \cdot U_v$  – the possibility arises to increase the signal/noise ratio at the gate input using a higher operating voltage. This option does not exist for TTL.

The greater the signal/noise ratio of a gate, the smaller the probability of malfunctioning and the noisier a signal can be without triggering malfunctions – a clear advantage of CMOS technology.

### Combining different logic families

When processing, linking, and conditioning signals, the process of combining gates, also from different families (e.g. TTL and CMOS), becomes inevitable. Various properties such as level and fan-out must be taken into account.

A comparison of the level diagrams of TTL and CMOS (Fig. 4) clearly shows that a TTL input can be connected directly to a CMOS output, since the CMOS output voltages are in the range of the TTL input levels. However, it must be ensured that the CMOS module supplies sufficient current to control the TTL circuitry. However, this does not usually apply vice versa, since the TTL-1 level is in the prohibited

Family	Type	$t_{pd}$
Standard TTL	7400	10 ns
Low-Power Schottky TTL	74 LS 00	10 ns
Schottky TTL	74 S 00	3 ns
Low-Power Advanced TTL	74 ALS 00	4 ns
Fast TTL	74 F 00	3 ns
Advanced TTL	74 AS 00	1.5 ns
Standard CMOS	4000	90 ns
	74 C 00	30 ns
High-Speed CMOS	74 HC 00, 74 HCT 00	≈ 10 ns (voltage dependant)
Advanced CMOS	74 AC 00, 74 ACT 00	≈ 3 ns
Low-Voltage CMOS	74 LV 00	14 ns
	74 LVC 00	7 ns
	74 ALVC 00	4 ns

Table 3: Switching times of TTL and CMOS components (source: Wikipedia)

range for CMOS. This problem can be solved with a 74HCT series CMOS that is compatible with TTL in terms of pin and function. It also makes the otherwise necessary pull-up resistor redundant.

The fan-out specifies the load capacity of an output, i.e. the maximum number of inputs that can be controlled by a gate output with-

out exceeding the required voltage level ranges for a logical 0 or 1. It is calculated as the quotient of the maximum output current to the maximum input current of the gates being controlled:

$$\text{Fan-out} = I_{O,max} / I_{I,max}$$

With TTL, the reduced input voltage limits the

maximum fan-out when distributing the current. A typical value is 20 gates.

With CMOS, the capacitance of the controlled ICs acts as a limiting factor, since the DC input current of CMOS logic ICs is in the micro-amp range. The input capacitance in this case is approx. 10 pF. The sum of capacitances that can be connected to an output is up to 500 pF. Theoretically, 50 CMOS logic ICs could be connected to a single output. It must, however, be noted that the rising edge of the signal waveform flattens out, thus increasing the propagation delay. The switching times become longer accordingly. A functional evaluation must therefore be performed on the board layout in advance to ensure the CMOS logic gates are functioning properly. However, increasing the number of inputs leads to an increase in power consumption, which in turn increases the power loss.

The gate switching time  $t_{pd}$  (propagation delay), i.e. the typical delay that a signal experiences between the gate input and the output, must also be taken into account when combining different gates. With TTL, the cause of the delay is the switching time of the transistor. In CMOS components, the time required to charge or discharge the load capacitance causes the propagation delay (switching of the FET). Table 3 shows a comparison of the gate switching times of TTL and CMOS components.

.....  
*Numerous families  
gathered together*  
.....

A wide range of eight logic families is offered by Diodes alone. Diodes, based in Plano, is a US manufacturer of semiconductor electronic devices such as diodes, rectifiers, transistors, and MOSFETs. The company has a broad portfolio of high-performance and small-footprint components available through Rutronik.

The logic families from Diodes include single-gate (AHC, AHCT, LVC, and AUP), dual-gate (LVC and AUP), and standard logic (HC, HCT, AHC, AHCT, LV, and LVC) for industrial, communication, consumer electronic, and computer applications. The automotive-compliant versions (with the suffix Q) are qualified to AEC-Q100, manufactured in IATF-16949-certified plants and undergo PPAP sampling procedures.

A special feature of the Diodes portfolio is the ultra-low-power logic AUP family. Its



## Properties of CMOS and TTL

Since CMOS has a low current requirement, the power supply is cheaper and easier to design for power management than with TTL elements.

CMOS components do not consume power in the static state, but power consumption does increase with the clock cycle. In contrast, TTL components offer constant power consumption.

Due to longer rise and fall times in CMOS gates, digital signals require less complex processing.

CMOS families have a wider operating voltage range than TTL. It ranges from 3 V to 15 V. Therefore, CMOS can be integrated in both TTL circuits and analog circuits operating with higher voltages. A voltage regulator is thus not required, reducing power loss and component costs.

TTL demonstrates greater resistance to electromagnetic interference. CMOS modules, on the other hand, are relatively sen-

sitive to static charge and must be protected against electrostatic discharge (ESD).

The energy balance of the components can be derived from the speed multiplied by the power per gate (speed power product, SPP). It is given in picojoules per gate. The lower their value, the better. CMOS significantly outperforms TTL with a value of 0.18 pJ/gate to 150 pJ/gate.

There is a crucial difference between the two technologies regarding the input circuitry: Unused TTL inputs can be left open if the environment is free of interference, as they always assume level 1. With CMOS, each gate input must be connected to a defined potential, as they can easily catch interference pulses, resulting in undefined circuit states.

CMOS has a larger signal/noise ratio between low and high signal levels than TTL and is, therefore, less susceptible to interference.

members have small input hysteresis, which makes them less susceptible to problems caused by slowly rising or falling signals. The AUP family is available in seven package types and is particularly suitable for battery-powered handheld applications, such as cell phones, tablets, e-readers, games, cameras, notebooks, and IoT devices.

The general-purpose logic single-gate or dual-gate logic products are available in small package variants such as SOT25/26/353/363. They are the perfect choice for standard applications, for example 74AHC and 74AHCT with a supply voltage range of 2.0 to 5.5 V and 4.5 to 5.5 V respectively. Lower trigger currents ensure that the circuits are more

robust to interference in the event of disruptions. The 74AHCT version is also compatible with TTL inputs.

The 74LVCx family enables mixed-signal voltage applications, as its inputs can be controlled from 3.3 V up to 5.5 V and used directly with TTL input voltage levels. ■

Advertisement



## Bosch Sensortec

### At the core of your everyday life

Bosch Sensortec GmbH markets a wide portfolio of MEMS sensors and solutions tailored for smartphones, tablets, wearables and hearables, AR/VR devices, drones, robots, smart home and IoT applications. The product portfolio includes motion sensors, smart sensors, and environmental sensors.

### A powerful combination: IMUs

Bosch Sensortec optimizes its IMUs (Inertial Measurement Units) for advanced wearables, hearables, AR/VR, drones, gaming and robotics applications. They are designed to provide maximum flexibility to customers. An IMU combines a gyroscope with an accelerometer in one system-in-package (SiP). It enables for example real-time motion detection, indoor navigation, gestures and activity recognition as well as optical image stabilization (OIS).

#### BMI323



- ▶ Successor of BMI160 with improved performance to address new use cases
- ▶ Integrated feature set for easy use for various applications
- ▶ Low current consumption and power mode configuration for continuous use

#### BMI270



- ▶ Ultra low-power
- ▶ Optimized for wearable and hearable applications
- ▶ Includes intuitive activity, context and gesture recognition

#### BMI088



- ▶ High performance
- ▶ Vibration robustness
- ▶ Optimized for drones and robotics

Intelligent display modules

# A smart path to a contemporary user interface

*Today, almost every embedded design requires a display. However, selection and integration pose challenges to developers and prolong the development process. Mass-produced intelligent display modules are often a cost-effective alternative.*

BY NIKOLAI SCHNARZ, CORPORATE  
PRODUCT SALES MANAGER DISPLAYS, AND  
GINTARAS DRUKTEINIS,  
TECHNICAL SUPPORT ENGINEER,  
BOTH AT RUTRONIK

**W**hen comparing a discrete design to a display module, the modular approach does not seem particularly attractive at first when considering the overall cost of materials. However, when taking the speed at which development can be completed and user-friendliness into account, the module comes out on top. For example, an existing application running on an 8-bit microcontroller (MCU) that now needs to be equipped with a full-color graphics display with touch interface. While most MCUs are capable of interfacing with an LC display via an integrated or discrete driver, the actual size and resolution of the display would be limited by the resources of the MCU. The 8-bit MCU can, for example, control a two-line dot-matrix display; but the processing resources may not be sufficient for larger displays. Moreover, the designer must add embedded software, such as libraries and image files. Adding touch functionality requires even more development effort. During the production phase, a strict incoming display inspection must be performed, as there is always the chance that something has been changed without prior notice, requiring optimization or redevelopment of the display drivers.

## What modules bring to the table

Intelligent modular displays usually have an industry-standard interface, such as I<sup>2</sup>C, SPI, or UART, for communicating with the host. Some also include an embedded microcontroller. This microcontroller is not only responsible for all the graphics elements, but often contains a variety of I/O and other peripherals, ensuring the module is able to run the complete target application.



Figure 1: Intelligent display modules are available in various configurations.

Many modules are supported by a library of functions, and this makes sure they can be relatively easily controlled by the host MCU. Some also have a full-featured integrated development environment (IDE) that includes graphical user interface (GUI) design and creation as part of the embedded design process. For extremely fast prototyping and application development without having to write a single line of code, some of these IDEs offer drag-and-drop WYSIWYG (what you see is what you get) workflows.



Figure 2: The Workshop4 IDE tool offers developers numerous GUI design options.

Image: 4D Systems

Image: 4D Systems

So the charm of the modular approach is that all drivers, primitives, and GUI functions have already been developed and tested. Engineers can therefore fully focus on the actual GUI design. The host MCU can offload all display tasks to the module, meaning all its resources are available for the main application.

*User interface design support*

To also support GUI design, display manufacturer 4D Systems has developed a tool to create intelligent graphical user interfaces as quickly and as easily as possible. Workshop4 IDE offers several development environments from text-based to visual programming (Fig. 2). Its drag-and-drop function makes it intuitive to use, thereby eliminating the need for traditional coding.

*Display module for the Rutronik Development Kit RDK2*

Due to all these advantages, Rutronik also uses an intelligent display module for its Development Kit RDK2 (Fig. 3). It primarily supports the development of proof of concept for diverse application areas, such as IoT and IIoT, smart wearables, and smart home.

The board is based on Infineon's CY8C6245A-ZI-S3D72 ultra-low-power, high-performance microcontroller. In addition, the RDK2 features an external 512 Mbit Semper NOR flash mem-



Image: Rutronik

Figure 3: The Rutronik Development Kit RDK2 with intelligent display module.

ory and a 64 Mbit AP memory APS6404L-3SQR-ZR PSRAM connected via a QSPI interface. This extends the capabilities of the RDK2 when using these memories simultaneously in memory-mapped mode.

The gen4-uLCD-43DCT-CLB 4.3" display from 4D Systems with integrated capacitive touch panel is used as the display and input medium for an application example of the RDK2 to determine air quality using the VOC index (vol-

Advertisement

*Expert on Acoustic Components*

Your best partner, Kingstate Electronics Corp., since 1977  
IATF16949 / ISO13485 / ISO45001 / ISO9001 / ISO14001

**BUZZER**



**SPEAKER & MODULE**



**MICROPHONE & MODULE**



Taipei / Guangdong / Suchou / Pinnan  
www.kingstate.com.tw



WEBSITE



## Functions required

```

/* UserApiConfig */
static bool uartAvailHandler(void);
static uint8_t uartReadHandler(void);
static void uartWriteHandler(uint32_t val);
static uint32_t uartGetMillis(void);
static void resetDisplay(void);

/* Event handlers */
static void myGenieEventHandler(void);

```

atile organic compounds). It is based on the DIABLO16 graphics controller and is controlled via the UART interface. Its data rate of 115,200 bit/s is sufficient for operating the touch panel without any noticeable delay. However, the UART data rate can also be increased to 600 kbit/s, if required.

We recommend the Arduino adapter 4D-ARDUINO-ADAPTOR-SHIELD-II to ensure quick integration with the RDK2. The firmware example RutDevKit-PSoC62\_GEN4\_ULCD\_43 refers by default to the data of the VOC sensor SPG40 from Sensirion, but it can also automatically switch to the onboard potentiometer POT1 if the sensor is not recognized on the I<sup>2</sup>C bus. The potentiometer is read via the ADC peripheral. The ADC values are then shown on the display. The RAB1 – Sensorfusion board with an SGP40 sensor will also be available from Rutronik.

The events, such as touching the keys, are received at regular intervals of 20 milliseconds or faster when this function is executed:

```

/* Check for events */
genieDoEvents(true);

```

Workshop4 IDE allows developers to design graphical objects and program them into the display memory. The sample application demonstrates the basics using an angular meter and a scope gadget for displaying the VOC index. The angular meter is refreshed every 50 milliseconds and the scope every ten seconds, allowing users to monitor both current and past VOC index values simultaneously.

The firmware example for the RDK2 and the Workshop4 IDE project are available for download on the Rutronik website: [www.rutronik.com/rdk2](http://www.rutronik.com/rdk2). ■

For visualization purposes, 4D Systems provides the ViSi Genie code library. It is included in the RDK2 sample project RutDevKit-PSoC62\_GEN4\_ULCD\_43 for use in the ModusToolbox IDE, a helpful collection of software and tools for the rapid development with Infineon MCUs. To enable the code library, the User API configuration functions and event handlers are implemented. They allow developers to control what should happen in the program when a specific event occurs, such as an input.

The function prototypes that must be implemented to ensure the ViSi-Genie stack can



This QR code provides quick access to more information on and a firmware example for the RDK2.

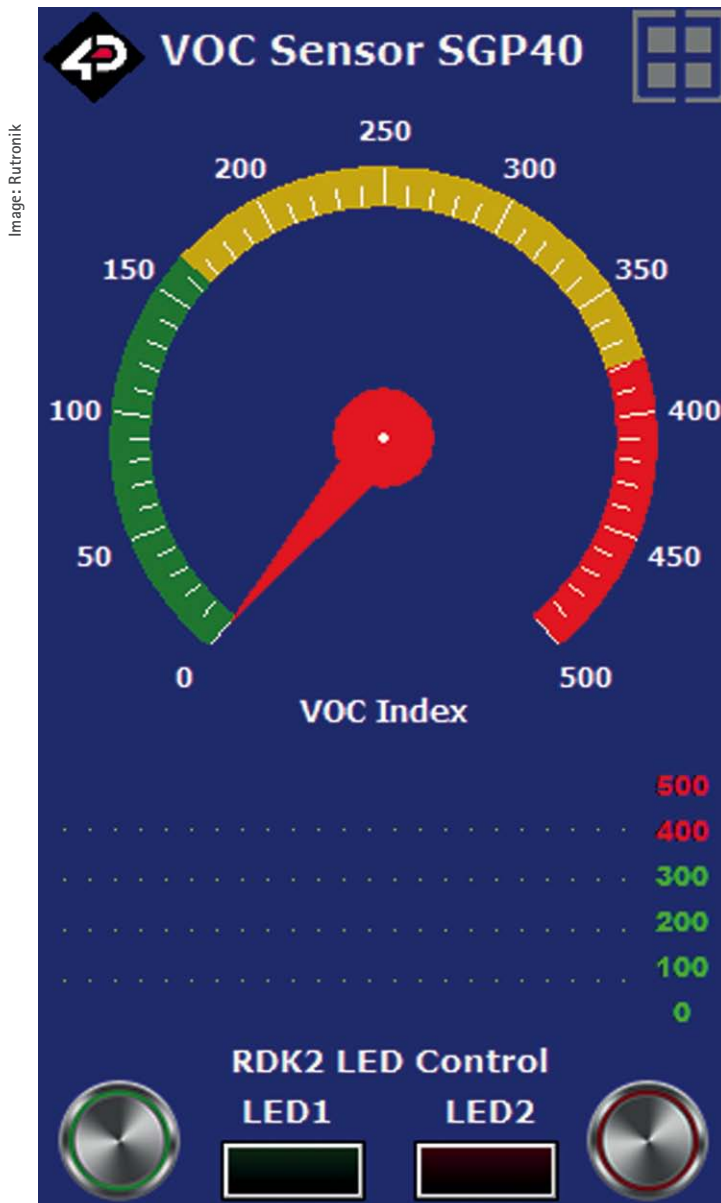

Figure 4: Screen layout of the RDK2 as displayed by Workshop4 IDE.



# Enabling Next-Generation Vehicle Technology

The automotive industry is transforming at a tremendous pace. As the advancements towards revolutionary technologies continue, consumers continue to demand greater functionality, connectivity and safety from their vehicles.

## WHAT IS DRIVING MINIATURISATION IN AUTOMOTIVE?

Electrification, connectivity, and sophisticated advanced driver assist systems are driving vehicle technology, with connectors competing for board and harness space in dense car architectures. Molex miniaturised automotive connector systems help meet the needs for reduced package size, space consumption, weight, and wire gauge as well as increased data rates.

Miniaturised Automotive Connector Solutions:

- DuraClik Connector System
- Easy-On FFC/FPC Connectors
- Mini50 Connection System
- Mizu Sealed Connectors
- SlimStack Board-to-Board Connectors
- USB Type-C Connectors

For more information on Molex's range of connectors for automotive, contact Rutronik or visit [www.rutronik.com/molex/](http://www.rutronik.com/molex/)



**molex**

*creating connections for life*

Development tools for embedded software

# Flexible workflow for more efficient development

*The success of a product also depends on the efficient development of the embedded software. Developers and teams must thus be able to work together as flexibly and efficiently as they can. The key question is: Which functions and capabilities do development tools need to have to enable this?*

BY RALF KERN, LINE MANAGER AT RUTRONIK, AND  
CLARK JARVIS, SENIOR STAFF TECHNICAL MARKETER AT INFINEON



**M**ost semiconductor suppliers offer their own development tools to support the efficient product development of their components. The question of whether they have everything necessary for this task can only be answered when considering more than just the tools. It requires a holistic development environment of hardware and software tools, embedded runtime drivers, libraries, documentation, and much more. Infineon's ModusToolbox software is used in this text to demonstrate what actually increases the efficiency of the embedded engineer's development work.

ModusToolbox is an extensible development environment that supports a wide range of Infineon microcontrollers and development kits. It contains a collection of various development tools, libraries, and embedded runtime assets for the flexible development of embedded software (Fig. 1).

The desktop applications can be used to create new embedded projects, manage software components, and configure peripherals and middleware; complemented by the typical development tools for compiling, programming, and debugging. They use numerous GitHub-hosted repositories from Infineon and partners that include code samples, board support packages, middleware, and application support.

Alongside documentation, training content, and a support community, this results in a complete workflow for embedded developers.

*The ideal  
development workflow*

When searching for the ideal workflow for embedded systems development, you do not have to look far. The first engineer you ask will swear that the procedure they personally follow is the right one. So, since each development team or embedded developer has their own unique workflow, the development environment should offer a high degree of flexibility. This is also a central pillar of ModusToolbox.

*Heart of the  
development process*

The heart of the development process is the integrated development environment (IDE). It is used daily by the embedded developer when coding and debugging embedded firmware. Ideally, it should be a familiar environment for every developer. ModusToolbox includes an Eclipse-based IDE for users who want to develop within the Eclipse framework and with

the Arm GCC compiler. Microsoft VS Code is available as an alternative editor and uses exactly the same Arm GCC toolchain and build commands. Thanks to the VS Code extensions, it provides full programming and debugging capabilities.

Furthermore, ModusToolbox projects can also be used on all leading IDEs and toolchains with native support for IAR Embedded Workbench and Arm microcontroller developers kit ( $\mu$ Vision).

But a flexible and efficient development environment must go beyond just visual code editors and graphical debugging. Therefore, the core of the ModusToolbox software is a Makefile-based build system and a command line shell to automate build systems and facilitate a continuous integration workflow. This scriptable build system is crucial for a truly flexible development environment that can be tailored to the exact needs of the developer. As such, the developer can be sure that the compiled output is consistent with the supplied Eclipse IDE or VS Code as it uses

exactly the same build system commands and compiler options.

This type of support for scriptable build commands and continuous integration result almost automatically in workflows for collaborative development. Version control, Git repositories, Make recipes – they are all crucial for the way embedded runtime assets are distributed and managed within ModusToolbox. At the same time, they are the central components for joint development within a team.

By extending these capabilities of ModusToolbox to the user application code, developers can collaborate efficiently as a team and ensure consistent and correct versioning of the provided drivers, middleware, libraries, and BSPs in the continuous integration build flows (Fig. 2).

For embedded engineers, every decision involves weighing up trade-offs and optimizations, from the selection of device and product features to the ideal balance between their

Advertisement



KYOCERA AVX's Aluminum Chip Capacitors are available in three advanced technologies to cover a variety of application requirements in an SMD style.



**POLYMER**

Polymer capacitors (APA, AVD, APV, APZ series) for power applications with requirements for lower ESR, higher ripple, stability over temperature, and longer life.



**HYBRID**

Hybrid capacitors (AHA, AHC series) for demanding applications requiring low ESR, DCL, humidity resistance, and good stability over frequency and time.



**ELECTROLYTIC**

Electrolytic capacitors (AEA, AEH, AEF, AEK series) for general purpose and applications like filtering and smoothing rectified alternating voltage, followed by buffering and energy storage.

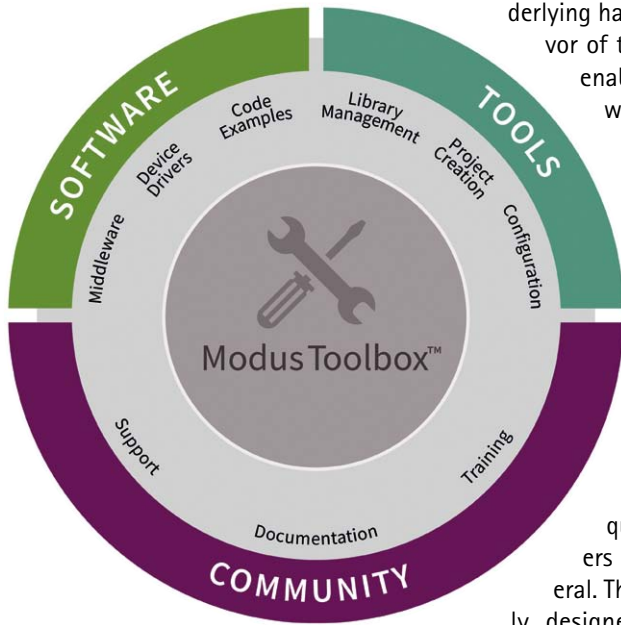

Figure 1: Efficient product development requires not only the ideal tools but also the appropriate software and community.

performance and capabilities, on the one hand, and their costs and power consumption, on the other hand, to the specific APIs used to develop an application.

*HAL and low-level drivers open up more options*

Quite often the API optimization options are limited by the drivers provided by the semiconductor supplier. This is not the case with the ModusToolbox software, as it provides both low-level peripheral drivers and a hardware abstraction layer (HAL). The hardware abstraction layer offers unified APIs that are consistent across various device families. As a result, application code developed with these functions is highly reusable and usually easier to program since some of the un-

derlying hardware specifics are hidden in favor of typical use-case functions. It also enables rapid integration of middleware libraries and communication stacks.

However, some trade-offs have to be made when working exclusively on an abstract level. Since any kind of abstraction leads to a certain degree of inefficiency, and the further you move away from the underlying hardware, the more you also move away from the detailed control of the peripheral in question. In contrast, low-level drivers provide full control of the peripheral. They also offer functions specifically designed for the characteristics and capabilities of the corresponding device.

Since ModusToolbox provides HAL and low-level drivers, an embedded developer can use both in one application. On the one hand, the necessary balance between portability and code reuse can be achieved with HAL APIs, and, on the other hand, code can be developed that is closely coupled to the capabilities of the hardware. Therefore, code and memory-saving software can be developed that is precisely tailored to the specific application in question.

*Middleware and libraries*

Yet another challenge faced by embedded engineers is the integration of libraries and middleware. Most semiconductor suppliers provide access to an industry-standard ecosystem of middleware that is specifically developed and delivered by the supplier, sometimes in collaboration with partners. Sometimes, the

offering is very rudimentary. Other suppliers provide reference examples within the development environment. These can be utilized as a starting point and illustrate that the middleware can work on the respective hardware. ModusToolbox also comes with code samples within the ModusToolbox Project Creator for sample projects from Infineon and partners.

The embedded developer is often left with the task of integrating this middleware into the specific application. ModusToolbox accomplishes this task with the help of a library manager that is capable of collecting the necessary source files from GitHub repositories, resolving any dependencies on related middleware, and updating the necessary Make recipes to include the selected sources. The documentation supplied with each middleware source folder describes in detail all the Makefile changes required to use the middleware in the application.

*Summary*

The basis for efficient development is a flexible development environment that allows the embedded developers to define their individual workflow. Together with one of the supported PSoC microcontroller development kits, ModusToolbox provides this level of flexibility, from selecting the supported IDE or command line build support to the various options for driver APIs and middleware integration. ■

Applications					Tools
Code Examples		Reference Designs			Project Creator
Middleware					Library Manager
Human-Machine Interface	Graphics	Connectivity	Security		Eclipse and partner IDEs
Voice / Audio	Machine Learning	Wi-Fi	Bluetooth®		Configurators and Tuners
BSPs					Git and Make build system
PSoC™ MCU	XMC™ MCU	USB Controllers	AIROC™ Connectivity Processor	AIROC™ Bluetooth®	

Figure 2: ModusToolbox from Infineon contains numerous tools as well as middleware with sample projects and various board support packages (BSPs).

# Enabling your innovation

Every day, in every part of the world, millions of people benefit from technologies which are enabled by Murata innovation.

Since 1944 Murata has been committed to developing components that help to advance the the benefit of electronics to society. In smartphones, smart homes, cars, computers, healthcare devices, wearables... in fact, wherever you find electronics, you'll find Murata innovation.

## Feature product

### UWB Modules

Ultra Wide Band (UWB) technology is good for secure and precise distance measurement which is based on Time of Flight (ToF) of radio waves.

Murata Type2AB module is designed as Ultra-small, high quality and lower power consumption UWB module. Ideally suited for small, battery operated IoT devices and applications.

#### Features:

- 75% less square area than CoB solution
- Integrated Wireless MCU
- Integrated 3-Axis sensor for saving battery
- Support Multi Antenna design and evaluation
- Integrated Filtering for UWB



## Feature product

### Crystal Units

Crystal units can generate clock signals which are essential for ICs and LSIs to operate, achieving high stability, adjustment-free performance and miniaturization.

Murata realizes stable supply for the component because of well-considered material and production machinery.

#### Features:

- Small size 2.0x1.6mm up to 50.0 MHz
- Unique design for better availability
- In-House crystal growth
- Self-alignment on bigger land pattern
- Available for automotive market

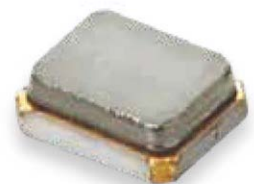

**muRata**

INNOVATOR IN ELECTRONICS

Cordless power tools

# Considering all trends and requirements in the design

*Cordless tools are obviously popular, as they put an end to annoying cables and the search for sockets. The trend is thus moving toward battery-powered tools. However, to ensure the required performance, a few design challenges have to be overcome.*

BY HANNAH METZNER, CORPORATE  
PRODUCT MANAGER POWER AT RUTRONIK

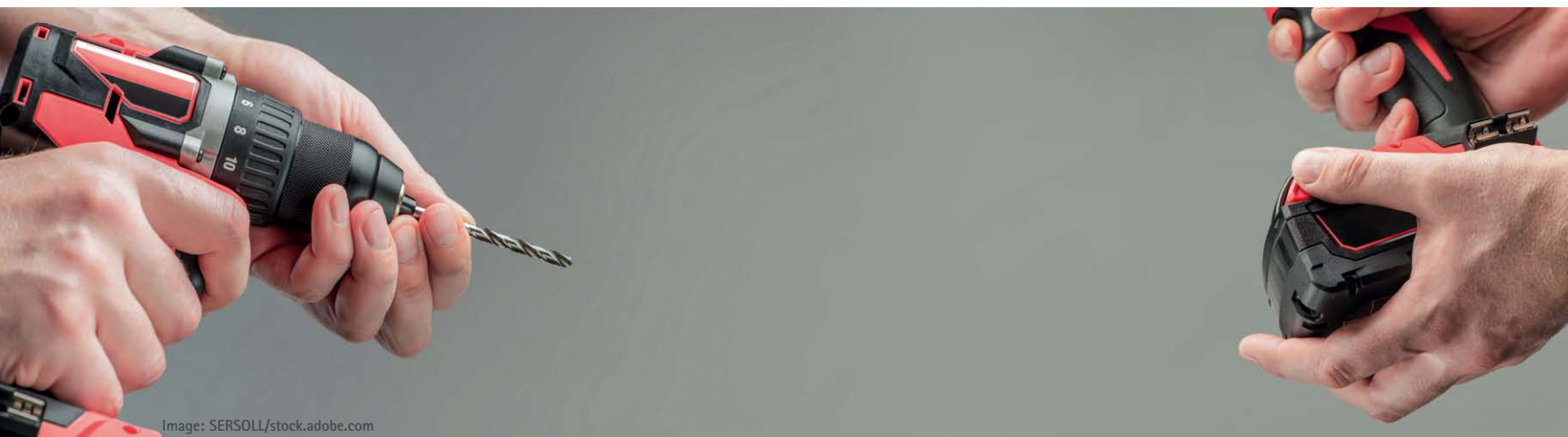

Image: SERSOLL/stock.adobe.com

Interest in battery-powered, cordless tools continues to grow. They can be roughly categorized, on the one hand, by the type of electric motor – brushed or brushless – and, on the other hand, by their voltage class.

The type of motor has a decisive impact on the electronic components required and the final performance of the tool.

The voltage class determines the operating voltage of the motor (3.6 V to 120 V) and thus directly or indirectly the battery stack voltage and the associated capacity and physical size of the battery. It also dictates the power of the tool – from small 12 V (or less) DIY products, standard 18 V category tools, and heavy-

er, more powerful 36 V and 72 V tools, which can replace internal combustion-powered equipment, all the way up to 120 V saws. Each of these categories has different design requirements in terms of ergonomics, battery safety, thermal management, motor controller, and additional functions such as communication or safety.

Both criteria, type of motor and voltage/power class, result in the performance of the tool, i.e. how long it can operate with one battery charge. The components of the motor controller for the BLDC motors must be perfectly matched to each other in order to ensure field-oriented control (FOC) with comparatively very high efficiency.

## Market trends influence the design

To guarantee competitive products, it is important to take certain market requirements into account in addition to technical ones (Figure). Current trends in cordless power tools include cost-optimized devices with a high level of energy efficiency that can be integrated into the Internet of Things (IoT) as well as the increased use of brushless DC motors (BLDC) and the transition from internal combustion engines to electric drives, e.g. in chainsaws. As a result, the avoidance of electronic waste is also becoming more and more important.

### Increasing energy efficiency

The service life can be enhanced by using larger batteries. However, this is accompanied by more weight gain and possibly a larger end device. Especially with regard to optimizing tool ergonomics, a motor controller that works effectively within the size constraints is required.

### Growing share of BLDC motors

Recent technological developments have enabled efficient brushless motors. Although they are currently still more expensive than comparable brushed models, they offer many advantages: They have no brush wear, they do not generate brush sparking, they are lighter and quieter, they allow more precise control, and they consume less energy. No wonder BLDC motors are becoming increasingly popular. Experts expect brushless motors to be fitted in two out of three cordless power tools by 2025.

### Optimizing costs

Cost optimization is a permanent trend in every market. But how can suppliers meet price expectations? One way is by utilizing high-efficiency circuits with lower self-heating and less internal losses. The size and capacity of the battery pack can also be smaller, if necessary. In addition, a higher current-carrying capacity of the power semiconductors with a more compact installation space may lead to a reduction in prices. Finally, integrated designs reduce purchasing and logistics costs.

### IoT-enabled and more sustainable

More and more everyday devices are capable of collecting and transmitting data. This also applies to power tools. A networked power tool not only has the ability to find its location but can also check its performance history and condition at any time. In the future, tools may even be able to automatically adapt their torque to the type of bit or blade being used. Regardless of future developments: Implementing connectivity is key to offering a competitive product.

Battery-powered tools are definitely more climate-friendly than those with internal com-

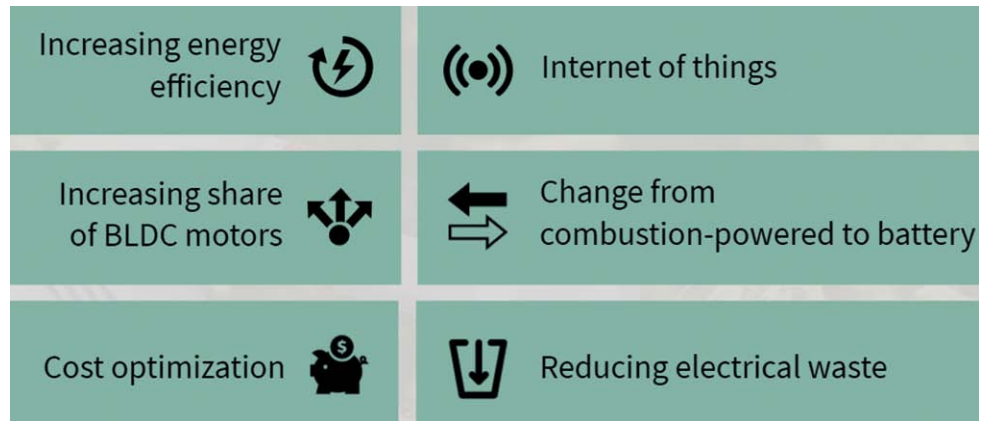

Market trends place their own requirements on the design of cordless power tools.

bustion engines, as they do not run on fossil fuels and are more energy-efficient. But what about the electronic waste? Unnecessary auxiliary equipment like special chargers are a prime example of electronic waste. In order to reduce it, several countries have already introduced corresponding regulations, e.g. on mandatory universal chargers.

USB-C chargers can currently only be used in power tools with low voltage (max. 20 V at 5 A); but in the near future, there will be a new power class up to 240 W with a maximum of 48 V at 5 A.

### Components for competitive tools

Infineon's portfolio offers suitable components to meet all these requirements. For example, the MOSFETs from Infineon are ideal for motor controllers and chargers. The type of power MOSFETs used – as in any application – has a direct impact on the overall system performance. That is why choosing the right technology is essential.

For the motor controller inverter, the supplier offers low-voltage MOSFETs in various packages. Their high nominal currents allow for increased current-carrying capacity. Further, the components withstand high surge currents during start-up and braking and should the rotor be blocked.

The best-in-class OptiMOS family is characterized by ultra-low  $R_{DS(on)}$ , high efficiency, and high power density. This makes it perfect for applications with high switching frequency.

For designs with low switching frequency and high current capability, the StrongIRFET-2 family is the perfect choice. It has been designed with rugged industrial applications in mind.

When it comes to charging solutions, thermal management is essential, especially for high-performance tools, to ensure safe operating conditions and to maintain system temperature limits.

On the high-voltage side, this can be achieved with the CoolMOS super-junction MOSFET family. It enables a higher power level at the same temperature or longer service life at the same power level due to a lower MOSFET temperature. For chargers, its high ESD robustness and low switching losses are also a major advantage. The latter increase the efficiency at higher switching speeds and thus enable smaller inductances.

On the low-voltage side, i.e. for the synchronous rectifier (FET) and the load switch, both the OptiMOS family and the StrongIRFET-2 family from Infineon are ideal. ■

Interview with Rutronik CEO Thomas Rudel

# “Strengthening the European market”

*In economic terms, 2022 will go down in history as a year plagued by record inflation and ongoing supply chain disruptions. What challenges has this presented for Rutronik, and what opportunities need to be identified and exploited in equal measure? In this interview, Rutronik CEO Thomas Rudel answers these and other questions about the role and added value of distribution; something that is currently on the minds of many in the industry.*



Markt&Technik  
EXCLUSIVE  
INTERVIEW

THOMAS RUDEL,  
RUTRONIK CEO

“Our ultimate goal – together with our partners – is to ensure sustainable growth and profitable operations in order to continue to act as an independent, privately owned company.”

**2022 is coming to an end. Can you give us an entrepreneur’s view of developments in the logistics and distribution industry?**

*Thomas Rudel:* Despite having the last month of the year still ahead of us, it is more than likely that semiconductor shortages and electronic component disruptions will continue to accompany us in some product areas over the coming months.

In 2022, as in 2021, the priorities have shifted somewhat. We are doing everything we can to support our customers to ensure production at their plants can continue as smoothly as possible despite component shortages and delivery holdups. When delivery dates have to be reorganized, we are always on hand to help out with suggestions for alternatives and ensure a continuous and transparent flow of information. It is absolutely essential that we maintain supply chains and prevent production processes from being interrupted. Ultimately, it is about keeping businesses trading and saving jobs.

**Is broadline distribution a competitive advantage?**

Definitely! The situation shows once again how important the comprehensive skills of Rutronik’s experts truly are. It includes monitoring supply chains and getting the latest information on the production capacities of the 150 or so suppliers in our portfolio. This enables us, as a broadline distributor, to provide our partners with a clear understanding of the challenges and dependencies.

Further, we support our customers not only in terms of logistical solutions and through our technical expertise, but we also marry up our concepts for Rutronik System Solutions with the very latest developments. This is important if we want to continue to be successful together in tomorrow’s world.

**You talk about Rutronik’s strategic orientation, which goes far beyond the procurement of components and parts and now also includes in-house system development. How did this transition from distributor to system partner come about?**

As a distributor, the needs of our partners are at the heart of everything we do. We analyze what the market needs, which business sectors are losing importance due to current dynamics, such as the energy and mobility transition, and what potential this offers in terms of technical innovations and new business models for our customers. Beside flexibly adapting our product portfolio to these developments, we actively support transitions and act as a strong partner for our customers.

**And what added value does Rutronik offer its customers exactly?**

Our comprehensive value-added services are additional real advantages that set us apart from other distributors and direct sales via suppliers. This enables the design and construction of automated logistics systems that are tailored to bespoke customer needs and can be expanded with further additional services, such as customer-specific packaging solutions and industry-specific process standards.

We are also involved in the life cycle of a product from an early stage. With our individual in-house solutions, some of which are patented, we can make a decisive contribution to the success of our customers as early as the preliminary development phase, especially with regard to the time to market.

**Which role does Rutronik System Solutions play?**

The aim of Rutronik System Solutions is to make the preliminary development phase more efficient for our customers and to sig-



nificantly accelerate the market launch. This shift toward becoming a system partner, with successful boards such as the recently launched Development Kit RDK2 and the Development Kit RDK3, which is on the verge of release, definitely creates additional added value that does not yet exist in this form on the market. These modular toolkits can be used to develop proof-of-concepts within a very short space of time. Moreover, it is possible to immediately create very specific use cases and applications and to test them without delay. And remember, all the components are available in Rutronik's portfolio. The actual availability of these components stands, alongside other things, at the core of the new developments. I believe that design for availability will play a key role in the future. We support this efficiency and acceleration by increasingly regionalizing our organizational structure.

**You refer to regionalization. Is this not the complete opposite to the trend toward ever-increasing globalization and internationalization?**

I am positive that future success is only possible through the successful combination of global standardization and regional adaptation. The development of our markets is becoming increasingly dynamic, while supply chains and value creation are becoming more globalized. This also goes hand in hand with regionalization, which must be taken into account. For Rutronik, this means that we need to be globally networked and at the same time more strongly focused on our respective regional markets to be able to serve our customers even better.

That said, it is becoming increasingly difficult, if not impossible, to manage a company with more than 80 branch offices in over 40 countries on three continents from a central point in Ispringen. Moreover, who knows the regional requirements better than the local employees? Therefore, we have decided to strengthen our regional market presence by developing field application engineering and product marketing expertise within our local teams.

This allows us to create faster decision-making mechanisms, enable communication in the local language, and increase the availability of specialist staff. In addition, we pool the required skills where they are needed and can thus bring our technical expertise to more customers, in more markets, more swiftly.

Regionalization obviously ensures we are closer to local customers in the market and

can better place products and contribute our technical know-how. In short, behind all our regionalization efforts and activities lies the principle of: Think global, act local. At the same time, this realignment enables the executive board and management team to focus even more on strategic development and to better adapt to medium and long-term market developments.

*“We analyze very precisely what the market needs.”*

**That leads nicely to my next question about the latest recruit to Rutronik's executive management team. How did that come about?**

At Rutronik, the executive management team is a "five-man team." In addition to myself, there are Markus Krieg as Chief Marketing Officer and Dr. Gregor Sommer as Chief Financial Officer. About 18 months ago, Ramon Demelbauer joined us as Chief Sales Officer, with the particular task of expanding and developing our global sales network. Efficient and agile processes with a flexible organization are critical factors for the success of the entire business. Over the past almost 12 months, my colleague Frank Altrock has been supporting the transition to a matrix organization as Chief Operating Officer (COO). The five of us represent a strong team with many years of expertise and a wealth of experience to steer Rutronik's fortunes, consistently and doggedly pursuing the course set, but always with a view to our long-term goals and success.

**Does this also involve investing in new locations? What is the latest on expanding Rutronik's international presence?**

Our ultimate goal – together with our partners – is to ensure sustainable growth and profitable operations in order to continue to act as an independent, privately owned company. We are always on the lookout for promising locations that are important for the expansion of our international activities, and obviously with the aim of serving new markets as a reliable partner and ultimately strengthening our relationships with our existing customers. Last year, we opened new locations in Vietnam and Malaysia. We also recently relocated our head office in the USA from Texas to Florida. But our headquarters in Ispringen is also part of our global growth strategy with

regard to staff expansion and development as we are an international company with strong local roots.

**How do you combine being locally rooted and yet committed to international growth?**

Throughout our almost 50 years, we have always taken well-considered steps with regard to further growth in order to be able to continue to act independently and to maintain a neutral position for our R&D activities and more than 40,000 customers within our network of suppliers and cooperation partners, such as universities and research institutions.

As a result of increasing globalization that began many years ago, we soon recognized that we can only maximize and further develop our strengths in the long term through international expansion. This also includes strengthening our position as an attractive employer. Further examples of this are guaranteeing secure jobs, further training opportunities for our employees, internal career paths, and the expansion of our teams.

**What challenges do you see for Rutronik in 2023?**

Rutronik always keeps a close eye on global markets. The European share of the global semiconductor market is less than 10%. Among the top ten suppliers in the global semiconductor market – accounting for around two-thirds of the total market – there are six US companies and only one European company, Infineon. We are very concerned about these developments and see considerable risks for Europe as a business location, especially in the high-tech sector. We are currently experiencing serious impacts on energy supplies and prices as a result of the war in Ukraine. We need to strengthen the European market and make ourselves more independent.

At the operational level, a look at some of the figures gives us a pretty good idea of what we, and above all our employees, achieve every day, and what challenges we face at various points in the company. Colleagues at the logistics center in Eisingen, for instance, perform roughly 13,000 picking tasks a day, shipping around 290 million articles to customers. Our customers can choose from 28 billion articles. I am always amazed by this outstanding commitment and enormously proud of our approximately 1,800 employees, who actively walk the path with us in times of growth and transition – in terms of Rutronik, as implied by my previous answers, but also with a view to economic and social developments. ■

## Partial discharge testing

# Testing the quality of low power transformers

*Not just faults in the insulation of transformers can be identified at an early stage through partial discharge testing. It is also a non-destructive and predictive analysis tool that warns of potential impending system failure.*

BY JOCHEN NELLER, TECHNICAL EXPERT INDUCTORS AT RUTRONIK, AND SHREYANKH KRISHNAMURTHY, FIELD APPLICATION ENGINEER AT PULSE

**D**uring their extensive service life, low-power transformers are subjected to a wide variety of stress. The electrical insulation, which is essential for fault-free operation, can be damaged as a result. Despite taking the utmost care, small defects, cavities, cracks, inclusions in the dielectric, or inhomogeneities in the electrical insulating materials may already occur during production. If the insulation is located between an electrode system with a voltage applied, the electric field can locally overstress the insulation at these weak points. This may lead to partial discharge. In contrast to full discharge – a frequently visible and audible breakdown – partial discharges are incomplete electrical breakdowns. They only occur in part of the insulation and are almost never noticed directly. However, over time they lead to increasing insulation damage, which may result in complete loss.

### *Diagnostic methods for quality assurance*

Dielectric diagnostic methods are essential for providing quality assurance and maintaining the operational reliability of power transformers. The most commonly used method for evaluating the integrity of insulation is a high-voltage or dielectric strength test (high-potential test, hi-pot test). In this case, a high voltage is applied to each side of the insulation and the leakage current is measured. This allows users to quickly identify whether the insulation is faulty. The disadvantage of high-

voltage tests is that the voltage (or the resulting leakage current) can damage the insulation and thus negatively impact the component. In addition, a hi-pot test can only detect defects that are already present.

Partial discharge testing, on the other hand, is a non-destructive method for evaluating the insulation condition of electrical equipment. This reliable and very sensitive method effectively detects the slightest of weak points in the insulation system.

Partial discharges often occur long before a defect in the insulation becomes apparent. The measurements therefore support quality assessment of the sample as well as strategic decisions regarding timely repair or replacement of the transformer before the equipment fails.

### *How partial discharge testing works*

Partial discharge tests examine the charge distribution within an insulated section during an ionization cycle and allow more accurate prediction of possible breakdowns. However, the signals that indicate partial discharge are relatively weak. For measurement, a defined voltage is applied to the insulated section. This also builds up across all the defects. Once the inception voltage  $U_i$  has been reached, the defect ionizes, thereby shorting itself out. When the voltage across the defect drops below the extinction voltage  $U_e$ , ionization ceases. During this process, the charge is redistributed within the insulated section. This is known as partial discharge. If the applied AC voltage is large enough, the partial di-

Figure 1: Test equipment for partial discharge testing with test chamber, partial discharge tester, and computer with measurement software.



Images: Pulse

charge cycle is repeated many times. The partial discharge activity increases over time and can lead to irreversible damage to the insulation systems and eventually to dielectric breakdown.

The total charge redistributed within the insulated section is a very good indicator of the number of faults and the probability of a failure occurring. If the limit for the partial discharge test is set low, a high-voltage failure will most probably not occur during the entire service life of the component. Partial discharge testing is used to determine the maximum dielectric breakdown insulation capability of the component and the continuous insulation capability for a realistic usage scenario of the component.

### Partial discharge testing

The tests and test setups depend on the type of equipment being measured and the standard according to which the partial discharge measurement is to be performed.

Pulse uses a procedure based on standards IEC 60664-1 and IEC 61800-5-1, which describe and specify a detailed process for performing partial discharge testing.

According to IEC 60664-1, the partial discharge voltage needs to be sinusoidal during AC voltage tests for the continuous insulation capability of the component. However, if a constant DC insulation strength must be confirmed, an equivalent AC partial discharge voltage is used. The relationship between AC and DC voltage is defined as  $U_{pd} = U_{dc}/\sqrt{2}$ ; where  $U_{dc}$  is the constant DC insulation voltage and  $U_{pd}$  the equivalent AC partial discharge voltage.

For a more stringent risk assessment, IEC 60664-1 prescribes different multiplication or safety factors. They include the environment correction multiplier (temperature, humidity), the hysteresis factor (difference between inception voltage  $U_i$  and extinction voltage  $U_e$ ), and the safety factor. At Pulse, this results in an overall test value of  $1.875 \cdot U_{pd}$  for the partial discharge voltage.

The test equipment for partial discharge testing is shown in Fig. 1. It consists of a test chamber, the partial discharge tester, and a computer with the measurement software for displaying the measured values.

Testing starts with a voltage below the nominal partial discharge voltage  $U_{pd}$ . This voltage is increased linearly to the test value of  $1.875 \cdot U_{pd}$  and held for a maximum of 5 seconds. The voltage is then reduced linearly to  $1.5 \cdot U_{pd}$  and held for a maximum of 15 seconds. During this time, the partial discharge is measured. Fig. 2 shows the voltage curve over time.

According to standards IEC 60664-1 and IEC 61800-5-1, a transformer passes the partial discharge test if the charge of the stray capacitances is less than 10 pC during the measurement period.

Fig. 3 shows the measurement of the charge of the stray capacitances during the partial discharge test. In Fig. 3 (top), the sample passes the partial discharge test because the

Advertisement

## NEW PCB POWER RELAY G2RG-X – **OMRON** COMPACT 500 VDC RELAY FOR CHARGING CIRCUITS

The G2RG-X is a highly compact 500VDC power relay aimed at the pre-charge circuits in EV chargers, battery back-up systems for solar panels and other high-current DC applications.

- Achieves 500 VDC 10 A switching capacity used with 2 pole series wiring
- 3.0 mm contact gap (2 poles series wiring)
- Offers high insulation with insulation distance above 8 mm and impulse withstand voltage of 10 kV between coil and contacts
- UL and TÜV certified



Scan the QR code to find a distributor

[www.components.omron.com/eu](http://www.components.omron.com/eu)



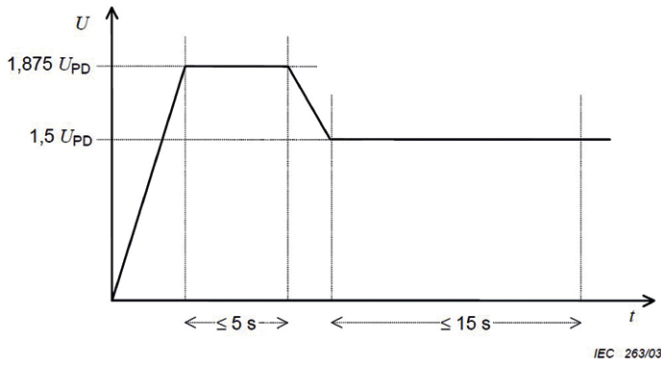

Figure 2: Voltage curve over time during the partial discharge test.

stray capacitance charge is less than 10 pC during the test period (see measured value PD1 and PD2). The component shown in Fig. 3 (bottom) does not pass the partial discharge test because the stray capacitance charge is well above 10 pC during the measurement period.

*Partial discharge testing for quality assurance*

Especially within the first few years of operation, insulation defects occur disproportionately. Therefore, Pulse performs a partial discharge test after production as a type and acceptance test to detect any quality problems that may have arisen during production.

This applies, for example, to the automotive-grade version of four popular push-pull transformer series from Pulse. These transformers in the IATF product portfolio are matched to several available push-pull driver ICs (Fig. 4) and deliver up to 3 W of power with insulations ranging from functional to reinforced and up to 5.5 kV rms galvanic isolation.

The PH90/PM21 series also includes Pulse's patented Sidecar package, which achieves a creepage distance of up to 12 mm in a compact SMD footprint.



Figure 4: Push-pull transformers.

These AEC-Q200-qualified transformers are used in communication, BMS, and IGBT drive applications, such as electric and hybrid vehicles.

The PH9185NL series (Fig. 5) is also tested for fatigue strength. The high-insulation switched-mode power supply unit transformers provide reinforced insulation for RS-485 and RS-232 transceiver ICs. The  $U_{PD}$  of the partial discharge test is 1,000 V rms; therefore, the fatigue strength (continuous) is also specified as 1,000 V rms.

*Summary*

Partial discharge testing is an excellent way to identify critical insulation weaknesses in a magnetic component. It indicates potential long-term problems and can also be used to establish a maximum continuous voltage rating. It is recommended to perform partial discharge measurements and analyses not only to confirm operational safety after production but also after commissioning and – depending on the type of equipment – throughout its entire service life.

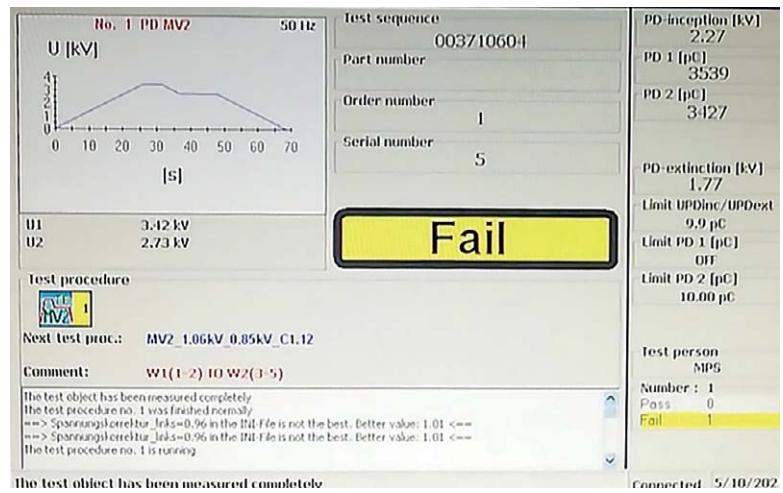
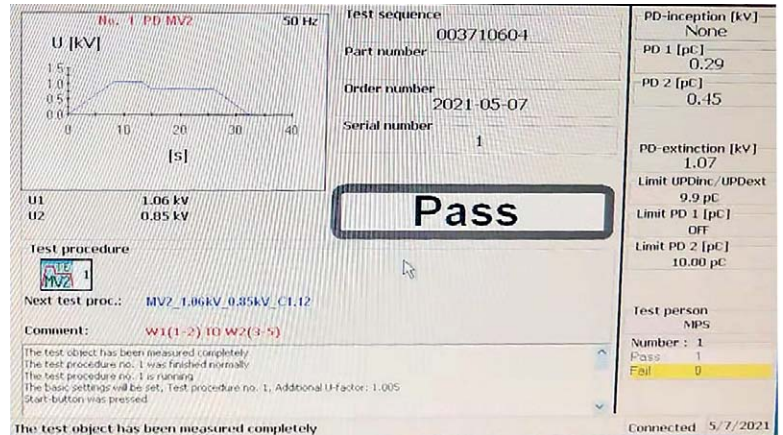

Figure 3: Measurement results of two partial discharge tests.



Figure 5: Push-pull transformer with reinforced insulation for separate power supply drivers, 8 mm creepage distance, 5 kV rms insulation (1,000 V rms continuous).

Why is F-RAM so important for data acquisition?

# Storing data efficiently and securely

*Non-volatile memory requirements in terms of data write and access speed, data retention, and low power are increasing, especially in mission-critical applications. A tried-and-tested technology that also meets extreme demands is F-RAM.*

BY CHEN WANG, CORPORATE PRODUCT MANAGER DIGITAL AT RUTRONIK, ZAREPOUR MAHROKH, SENIOR MANAGER REGIONAL MARKETING, AND GABRIEL PHILIPP, DIRECTOR BUSINESS MANAGEMENT DISTRIBUTION EMEA, BOTH AT INFINEON

Images: Infineon Technologies



**D**ata acquisition has always been a very essential element in mission-critical environments and applications. A battery-buffered SRAM (static random access memory) was therefore usually used to store data. Even though it ensures a high level of safety and security, SRAM has various drawbacks:

- Several components are needed (battery, power management controller) which take

up a lot of PCB space and have a high failure rate.

- To prevent the battery from overheating, it is usually assembled after the reflow process, which ultimately results in higher production costs.
- Industrial robots and vehicles are often subject to vibration, resulting in connectors that hold batteries in place becoming loose

or detached. This reduces the reliability of the entire system.

- The batteries also need to be maintained and replaced during the long operating life of a typical industrial robot or vehicle.
- Moreover, the batteries fail to comply with RoHS directives and often create issues for operators when it comes to disposal.

For these reasons, non-volatile memory (NVM) is increasingly being used in industrial applications. EEPROMs are often the first choice. They are, however, usually unsuitable as most applications require real-time reliability for data acquisition. Further, EEPROMs are not particularly energy-efficient. However, low power is a critical factor since data must be continuously collected in these applications.

*Main memory requirements*

Due to the requirements of continuous data acquisition and the demand for a long service life, memories for industrial and automotive applications, but also for medical applications, must offer practically unlimited endurance.

F-RAM (ferroelectric random access memory) has a higher endurance than EEPROM and – in contrast to EEPROM – stores data immediately (see table). It is energy-efficient, and does not require an additional battery to have

	F-RAM	EEPROM
Write operation	Overwrite	Erase + Write
Write cycle time	Instant	5 ms
Write energy (4 Mbit)	1,510 µJ	192,000 µJ
Endurance	10 <sup>14</sup> cycles	10 <sup>6</sup> cycles
Cost/Mbit (€)	€€€	€€

F-RAM works out far more advantageous than EEPROM in every area.

enough energy for storage in the SRAM. Moreover, a memory controller is not necessary, which saves both space and money. The reduced number of components also enhances reliability. Yet another advantage is the large variety of products available on the market, ensuring availability of the ideal F-RAM solution for every application.



Figure 1: With nearly unlimited service life, reliable and delay-free data acquisition, and high data throughput, Infineon's Excelon F-RAM is ideal for data acquisition in ADAS, industrial robots, and medical devices.

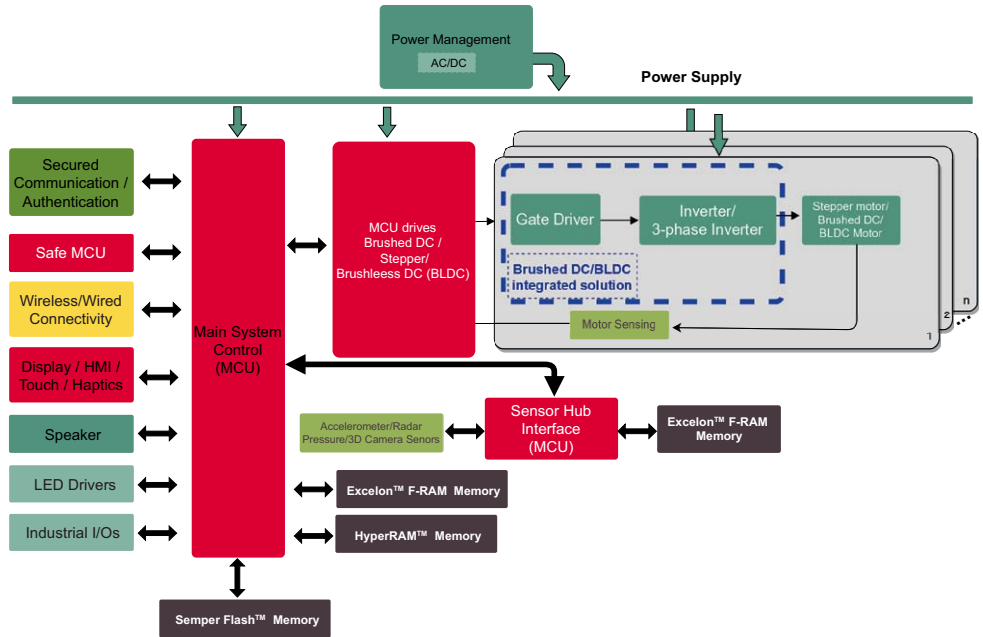

Figure 2: For robot controllers, Infineon's Excelon F-RAM modules provide the necessary memory density and a quad SPI for rapid data throughput.

*Data acquisition trends*

Trends shaping data acquisition in corresponding applications can currently be observed in industry, as well as in the medical and automotive markets.

**Trend in the industrial sector:** Designers of industrial applications need to look at whether data acquisition should occur centrally in the main microcontroller or separately at each motor. At present, data acquisition applications require up to 1 MB of memory at the motor. With controllers, on the other hand, up to 16 MB are required.

For high-speed applications, such as six-axis robot controllers, Infineon's latest NVM generation, F-RAM Excelon, offers high memory density and a quad SPI (QSPI) for fast data throughput. For applications with lower requirements, for example a motion control application with three motor controllers, lower density models with a serial peripheral interface (SPI) are also available from the series.

**Trend in the automotive sector:** Automotive systems require continuous data recording and must acquire sensor data without delay if power fails. In harsh operating environments with extensive requirements on the number of read/write cycles and data retention, the most stable performance possible is necessary, which also supports efficient interfaces with a low pin count and high speed.

The F-RAMs of the Excelon Auto series have been designed specifically for this purpose: They acquire data immediately without any holding time and the need for additional components. They support a QSPI with up to 108 MHz and are AEC-Q100-1, -2, and -3 qualified. The storage components thus meet the criteria for functional safety and security. With 100 trillion write cycles, an Excelon chip in the car can write data for 20 years.

**Trend in the medical sector:** Increasing connectivity and the Internet of Things with wearables and remote patient monitoring systems are enabling care that is gradually transitioning from hospital to home. Drivers of this development are a rapidly aging population and rising health care costs, especially in industrialized nations.

Mobile medical devices for the home, such as infusion pumps or pacemakers, enable remote therapies. However, this requires significantly more extensive and reliable real-time data acquisition to ensure efficient and secure operation, also in the event of possible power failure. Low power plays a key role in this respect to maximize the battery life of devices.

Thanks to delay-free write functions, virtually unlimited service life, and ultra-low power modes, the Excelon F-RAM devices meet all the requirements (Fig. 1). Equipped with the latest QFN package, they also offer a small form factor – an advantage especially for wearables. In addition, Infineon's F-RAM cells

are robust enough to withstand magnetic field intensity and radiation. They thus reduce risks from external systems and prevent further intervention to replace storage components.

*Summary*

The examples show that the demand for reliable, fast, low-power, and high-performance F-RAMs has increased significantly across a

wide range of applications that rely on data from multiple sensors. This is especially true in mission-critical areas, where data loss can significantly compromise safety and security mechanisms.

Furthermore, data acquisition plays a key role as an enabler of new AI and ML capabilities, such as predictive maintenance. It provides the data that help to promote innovation in these applications.

Their virtually unlimited service life combined with instant and reliable data acquisition and high data throughput make Infineon's F-RAMs first choice for high-performance data acquisition in ADAS, industrial robots, and medical devices. Thanks to their varying densities, F-RAMs meet the requirements of various applications. This also gives developers the flexibility to meet the yet-to-emerge requirements of next-generation edge technologies. ■

Advertisement

Eaton provides automotive grade signal line filtering solutions and expands the portfolio in this direction.

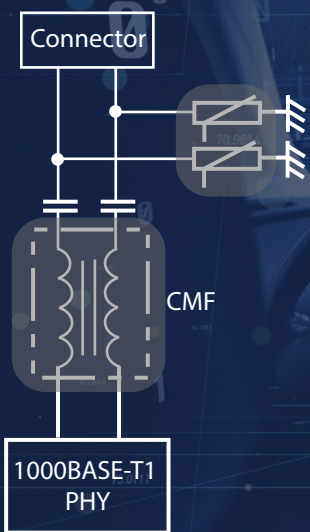

Auto Communication Protocol			CAN & CAN-FD	FlexRay	USB2.0	One-pair Ethernet 100BASE-T1	One-pair Ethernet 1000BASE-T1	PoC
Product	Footprint (EIA)	Series						
Common/ Differential Mode Filter	0805	ACE1V				●		●
	1210	ACE1V ACE2V	●	●		●	●	●
	1812	ACE1V	●	●				
ESD Suppressor	0402	AMLV	●	●				
	0603		●	●				
	0402	PolySurg		●	●	●	●	



New memory technology for innovative IoT applications

# The golden mean

*Whether vehicle infotainment, wearables, smart home, or smart factory applications: They all need to be scalable to ensure innovative user experiences and functionalities. This requires MCUs offering higher performance and lower power consumption. These parameters are often set limits for the memory, but they can now be overcome thanks to a new technology.*

BY CHEN WANG, CORPORATE PRODUCT MANAGER DIGITAL AT RUTRONIK, AND ALEX DE LA BASTIE, BUSINESS DEVELOPMENT DIRECTOR AT AP MEMORY TECHNOLOGY

**M**ost MCUs or FPGAs are equipped with an internal memory optimized for a few applications, meaning they cannot satisfy every requirement. This is especially true for applications that require high memory capacity and high bandwidth to perform operations. These include image/audio buffering or machine learning (ML), which demand an extensive neural network.

### Conventional external memories

Typically, an external memory is the most viable and easily scalable method for these applications. Depending on the density and performance requirements of the target application, the conventional SRAM (static random access memory) and SDR/DDR DRAM (dynamic random access memory) options are available to users. Due to their different technologies and architectures, they have varying density and performance specifications. However, both are generally unsuitable for innovative IoT applications, since next-generation IoT applications require a wider range of functions with a compact design and high energy

efficiency. For example, the usual layout topology of a six-transistor SRAM has not shrunk at the same rate as the process nodes. This means that the memory does not support higher density and is relatively expensive. It is thus increasingly uneconomical to use SRAM to meet the demands of the latest IoT applications that require high memory capacity.

Although DRAM offers cost advantages over SRAM, as it consists of only one single transistor and capacitor, it also has some disadvantages. The biggest ones are the high pin count, high power consumption and complex integration. For applications without constraints in this respect, legacy SDR DRAM remains a possible option for existing systems. They are, however, hardly suitable for many cutting-edge, compact IoT systems.

Fig. 1 presents the available external memory options with the parameters designers need to consider when selecting them. It clearly shows that embedded SRAM is the best memory technology for SoC applications. That said, there is also a limiting factor here: Due to the chip size and cost of integration into the logic process, the density of embedded SRAM is limited. Moreover, as MCUs continue to evolve and migrate into modern IoT application processes, embedded SRAM is losing its advantage in standby performance.

DRAM, on the other hand, while suitable for high-end applications, is often overkill for many other IoT applications. The reason for this is that the pin count, speed, and power are far too high.

An alternative memory technology is PSRAM (pseudo SRAM). Here, the power and the number of ports are ideally balanced, and it has low power requirements.

Figure 1: Comparison of external memory technologies.

Spec	SRAM (Embedded)	DRAM	PSRAM
Pin Count	None	High	Low
Cost	Very High	Wide Range	Low
Standby Power	Low to High (Mature/Advance Node dependant)	High	Very Low
Speed	High	Wide Range	Low
Active Power	Low	High	Medium
Platform	Embedded	Standard	Standard
Random Access	High	Medium	Low

Image: AP Memory



*IoT RAM fills the gap between DRAM and SRAM*

IoT RAM is based on PSRAM technology, assuming its features and combining them with a relatively simple SRAM interface for easy product design. With additional interface options, such as NOR flash SPI interfaces with low pin count used by most MCUs, IoT RAM is an option wherever SoCs need more memory than the internal SRAM can provide.

Looking at the costs, the product costs of IoT RAM are up to ten times lower than those of SRAM. At the same time, IoT RAM has five to ten times higher memory density as it uses DRAM memory cell technology with only one transistor and one capacitor.

*Low pin count*

Compared to SRAM, IoT RAM offers a higher data bandwidth and is comparable to conven-

tional SDRAM, but with a much lower pin count (Fig. 2). With IoT RAM, the IO configuration can support a 1-bit, 4-bit, 8-bit, and 16-bit data bus.

IoT RAM therefore significantly reduces the number of pins required for the bandwidth of modern IoT applications (Fig. 3). Moreover,

the system design is simplified and the SoC pins can be used for other purposes.

IoT RAM also has a significant advantage over DRAM in terms of the pin count: x16 IoT RAM requires three times fewer pins than x32 SDRAM with comparable data throughput. This leads to a reduction in the size of the chip

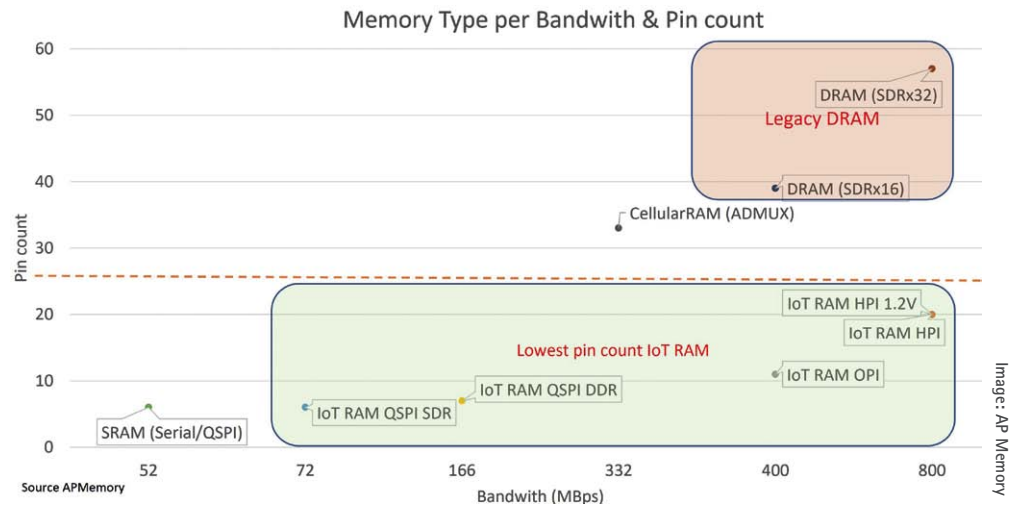

Figure 2: IoT RAM offers a higher data bandwidth than SRAM with a much lower pin count.

Advertisement



**SaFT**

# The energy behind the power

## Saft batteries for IoT

**Choosing the right battery for your IoT solution is critical.**

When your application involves connecting thousands of devices and needs to perform reliably for years at a time, you want to know you are making the right battery selection. Saft makes it easy with our smart selector tools. Find the best battery to energize your IoT device.

[saftbatteries.com](http://saftbatteries.com)



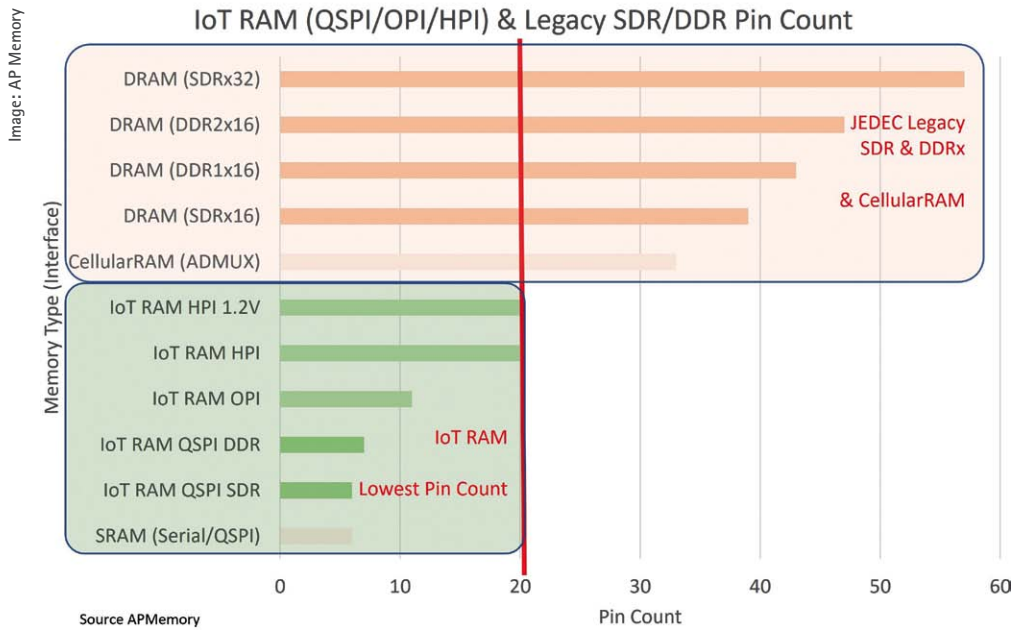

Figure 3: Comparison of the pin count of IoT RAM and SDRAM.

and thus a reduction in silicon area, costs, and PCB size. Compared to an SDRAM x32 BGA90, the package of an IoT RAM BGA24 is up to three times smaller and thus extremely space saving. In addition, MCU pins are freed up for other purposes and the memory is also optimized for burst memory access.

*Low power consumption*

In terms of energy consumption, IoT RAM requires around four times less pJ/bit (picojoules per bit) than conventional DRAM (Fig. 4). The short latency of IoT RAM enables fast power-up times and very fast wake-up from low-power modes and stand-by mode. Further-

more, IoT RAM offers full data retention with ultra-low standby power consumption – typically 0.1 to 0.3  $\mu\text{A}/\text{Mbit}$  depending on density – as well as a deep power-down mode with less than 8  $\mu\text{A}$  for all octal peripheral interface (OPI) densities.

*IoT RAM for frame buffering with MCU*

The IoT RAM memories from AP Memory are based on PSRAM technology and already work with many MCUs, SoCs, and FPGAs that are widely used in IoT and embedded devices.

For a smart wristband, the required data throughput is calculated to be roughly 5 MB/s

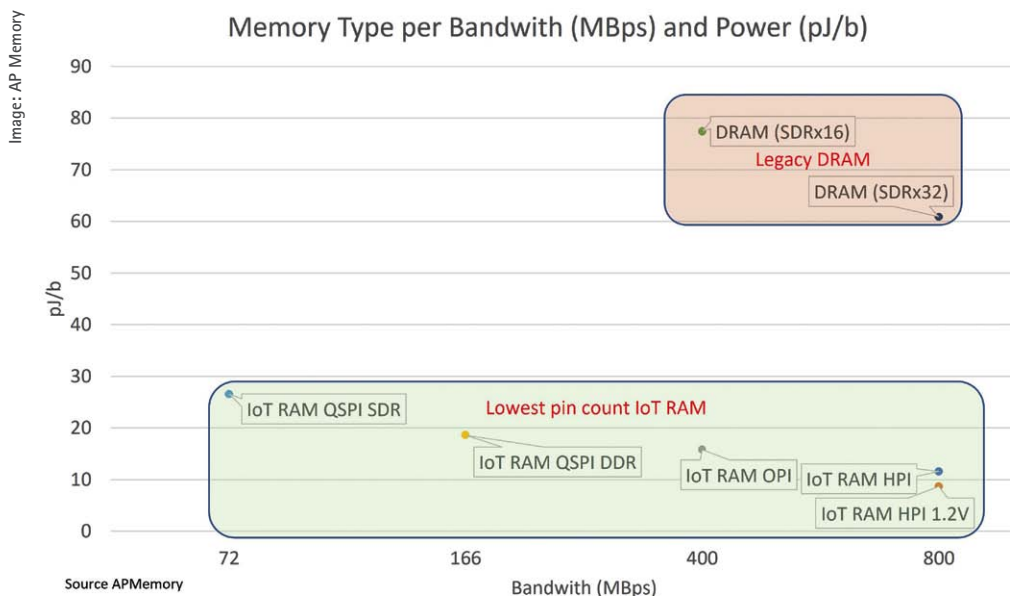

Figure 4: Bandwidth and power consumption of different types of memory.



Image: Rutronik

Figure 5: Using external IoT RAM, RDK2 is a modern and easy-to-use hardware platform, especially for the development of wearables and sensors.

(71,392  $\times$  3 bytes  $\times$  30 fps). Considering the additional latency for the SoC bus and the choice of memory bus frequency of less than 100 MHz for many SoCs in this category, IoT RAM QSPI SDR is sufficient to achieve the required data rate.

With a simple smartwatch, on the other hand, the required data throughput of roughly 25 MB/s (135,424  $\times$  3 bytes  $\times$  60 fps) is well above that and can even be higher depending on the actual model. In this case, IoT RAM OPI or HPI achieves the necessary data rate better. For high-volume, competitive wearables, the WLCSO package options are recommended.

IoT RAM with a wide range of bandwidths is also available for the smart home and industrial market. For example, an entry-level 16 MB QSPI SDR-SOP8 IoT RAM is suitable for a simple thermostat display that requires about 10 MB/s. The high requirements of an HD 720p display, on the other hand, can be met with a 256 MB OPI or HPI IoT RAM in a BGA24 package.

*IoT RAM: Turning point for many MCU-based applications*

These features have made IoT RAM the memory of choice for wearables in recent years.

Many of the latest MCUs, wireless SoCs, and FPGAs from market-leading manufacturers view this memory as the ideal choice for all IoT, edge AI, and industrial applications.

Using reference designs from SoC partners and Rutronik, manufacturers can ensure the effective use of their developer resources and a short time to market for their projects. Rutronik's RDK2, for example, is based on Infineon's PSoC 62 and, in combination with external PSRAM (64 Mbit QSPI), offers a modern and easy-to-use hardware platform for developing numerous applications, most notably wearables and sensors.







Frame buffering requirements and IoT RAM solution	Wristband 	Smart Watch 	Thermostat 	Thermostat (HD Display) 
(R,G,B) 3Bytes/Pixel (24bits)	194 x 368	368 x 368	320x320	720p
1 Frame Size	~200KB	~400KB	~300KB	~3MB
Frame per sec	30fps	60fps	30fps	60fps
Bandwidth MB/s	~5MB/s	~25MB/s	~10MB/s	~160MB/s
Suggested Memory	IOT RAM QSPI SDR 16Mb WLCSP 	IOT RAM OPI 64Mb WLCSP 	IOT RAM QSPI SDR 16Mb SOP8 	IOT RAM HPI 256Mb BGA24 

Image: AP Memory

Examples of image storage requirements for varying applications

*Summary*

Low pin count, low power consumption, a wide choice of packages, as well as competitiveness and simplicity in design, and integration of IoT RAMs make the real difference compared to conventional and legacy SDRAM approaches. ■

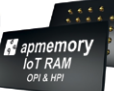
Advertisement



## AUTOMOTIVE-GRADE POWER MODULES

### Smaller than an 1825 capacitor

- Wide operating temperature from -40°C up to +125°C  
AEC-Q100 Grade 1
- 36VDC Vin / 0.5 or 1.5A Iout
- Excellent performance for automotive systems
- Optional wettable flanks for easy optical inspection
- Adjustable output voltage
- High efficiency, no need for heatsinks



- High power density in compact QFN packaging
- Integrated FETs, inductors, and passives for simple design
- Fully-protected with SCP, OCP, OTP, and UVLO
- Simple class A or B filtering

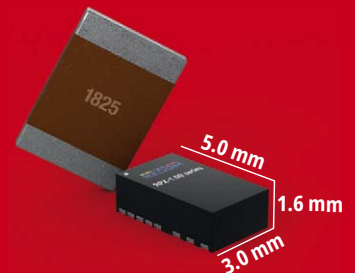

**WE POWER YOUR PRODUCTS**  
recom-power.com/mobility



Design-in of eMMCs in various environments

# Long live the memory!

*eMMC memories have been around for a number of years, especially in smart-phones, TVs, set-top boxes, computer-on-modules, notebooks, and tablet PCs. But they are also ideal for use in IoT sensors. Various aspects do, nevertheless, have to be considered when it comes to design-in.*

BY CHEN WANG,  
CORPORATE PRODUCT MANAGER DIGITAL  
AT RUTRONIK, AND  
MARTIN JUTTNER,  
SENIOR MANAGER PRODUCT MARKETING  
FOR EMBEDDED FLASH MEMORY  
AT KIOXIA EUROPE

One advantage of eMMCs (embedded MultiMediaCards) is that they are standardized by the technology standards association JEDEC. Pin layout, register designations and usage, power supply, and controller functions are thus defined and managed memories backward compatible. Each standard update is given a new number, indicating that this eMMC generation supports the features of the previous one plus new and improved features.

From JEDEC 5.0 and higher, the eMMC firmware supports a service health report, which assists with the design process and field maintenance. Similar to the well-known S.M.A.R.T. functionality from SSDs and HDDs, it delivers basic data on the current state of the flash cells within the eMMC. This provides the host with information on the remaining write/erase cycles and the overall state of the eMMC's flash memory based on the remaining spare blocks.

As such, live information is available about the state of the memory after it has already been used for a certain period of time under certain conditions. This information can serve as the basis for simulating expected field use over many years in the lab and learning how this impacts the longevity of the data.

Thanks to the level of standardization, a design created for an older eMMC version can also be used for the latest generation. The new features or interface options of the younger generation are not available in this case, but all the features of the older one are also implemented into the new generation – ideal for applications with long development cycles.

A potential obstacle may, however, be the driver of the MMC interface on the host. It may initially ask for the JEDEC version of the eMMC and abort if it fails to recognize the input number. This stumbling block can be avoided by updating the driver.

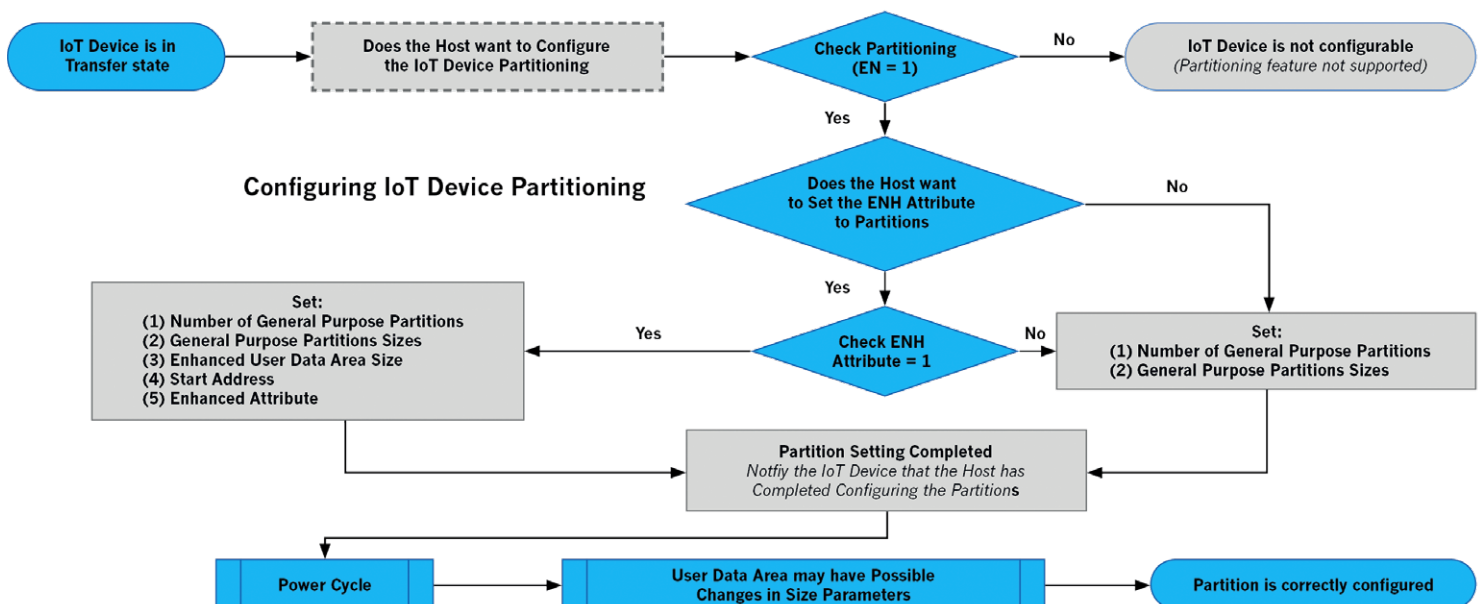

Figure 1: eMMC partitioning shown here using the example of an IoT product.

Seeing as the pin assignment is also standardized, developers can freely choose between the various package versions and memory densities. A BGA measuring 11.5 mm × 13 mm is the typical package size for a standard temperature eMMC. Kioxia also offers a smaller 11 mm × 10 mm BGA package for the 4 GB eMMC.

*Temperature influences data retention*

The first question that needs to be answered when considering the design is: What memory density is required for the data in the customer application? eMMCs are available in capacities of 4 and 128 GB.

It is also essential to take into account the ambient temperature in which the eMMC is to be used. The standard operating temperature range is -25 to +85°C. For applications where this is not enough, e.g. computer-on-modules (CoMs) that can be used in widely varying environmental conditions or power

inverters for solar systems, Kioxia offers eMMCs with an extended temperature range of -40 to +105°C in capacities of 8 to 64 GB.

However, the temperature range only indicates the operating temperature for the eMMC, not how long the data are retained. If the eMMC is operated frequently over a long period of time at temperatures significantly above 40°C, users are well advised to talk to the supplier about the individual application. This excludes the possibility of experiencing shorter data retention periods.

Another way to make data more robust to higher temperatures is to use the enhanced user data area, also known as "pseudo SLC" mode. The enhanced user data area is available from eMMC standard 4.4 and higher, thereby making the storage area in question more reliable and powerful. It must be noted, however, that this reduces the available overall density.

The enhanced user data area improves the reliability, performance, and endurance of an

eMMC by using only one instead of two bits per cell.

*Increasing the data transmission rate*

If the application requires a certain data transmission rate, several points need to be considered. It is important to know that there is a correlation between the memory density and the read/write performance of an eMMC. If the application requires a higher data throughput rate than provided by a standard eMMC, the following options are available:

- If mainly the reading speed is to be improved, switching from the HS200 to the HS400 interface is a good idea. However, HS400 is only available from JEDEC 5.0 and higher and requires an additional pin for the interface.
- If mainly the writing speed is to be improved, switching to the enhanced user data area is an efficient approach. Note, how-

Advertisement

[www.sensirion.com/sen5x](http://www.sensirion.com/sen5x)

# Environmental Sensor Node SEN5x

## All-in-one air quality sensing

**Measure the air quality in your environment**

Accurate measurement of various environmental parameters, such as particulate matter, volatile organic compounds (VOCs), nitrogen oxides (NOx), as well as humidity and temperature. Thanks to proprietary algorithms, the module enables straightforward integration into HVAC and air quality applications.

- FPM, NOx, VOC, RH&T sensor platform
- Superior sensing accuracy and lifetime
- Fast and easy integration
- Fully calibrated digital output
- One driver for up to 8 data signals
- Optimized and tested flow channel geometry

**SENSIRION**

$$\text{Days until 1 year data retention limit is reached} = \frac{\text{Number of write erase cycles offered by the NAND} \times \text{Total available density in GB}}{\text{GB per write to Memory} \times \text{Number of writes per Day} \times \text{WAF}}$$

Figure 2: Formula for calculating the expected service life of the eMMC.

ever, that this reduces the available level of density.

*Determining and extending data retention*

Data retention is basically influenced by two factors: the number of write/erase cycles during the service life and the operating temperature. An MLC-based NAND flash memory in an eMMC offers around 3,000 write/erase cycles at 40°C. Whether this is enough for the expected service life of a product in which the eMMC is used depends heavily on the usage scenario. When calculating the expected service life of the memory, the WAF (write amplification factor) must also be taken into account. Fig. 2 shows the corresponding formula.

The result is, however, not a reliable value but only an approximation, as the actual data retention rate additionally depends on the specific usage of the individual device. If, based on this calculation, it is possible to assume that the service life of the eMMC in the anticipated usage scenario does not correspond to the expected service life of the product, there are two ways to extend it:

- Using the enhanced user data area. This increases the number of available write/erase

cycles by a factor of ten compared to the normal mode (at 40°C). The following also applies in this case: The available density is reduced.

- Selecting a high-density eMMC. The more density available, the greater the area of the memory controller for wear leveling. This means less stress from the write/erase cycles for the individual cells.

*eMMCs in production environments*

Once the design has been completed, yet another aspect has to be considered in the production process if the data are to be loaded to the memory prior to the reflow or soldering process. At a temperature of approximately 260°C, the soldering process exposes the NAND cell to extreme stress. This might have a negative impact on data retention or even lead to data loss. To avoid this unwanted scenario, Kioxia has developed a special firmware function. Basically, there are only restrictions regarding the maximum data size that can be processed with the aid of this function.

If these considerations are accounted for during the design process, designers are provided with a durable, high-performance, and reliable memory solution based on eMMC. ■

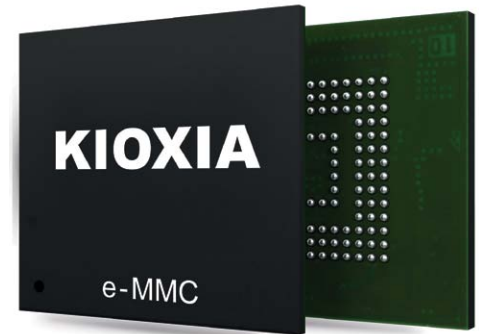

Figure 4: Equipped with a special firmware function, eMMCs from Kioxia survive the soldering process without any damage to the data.

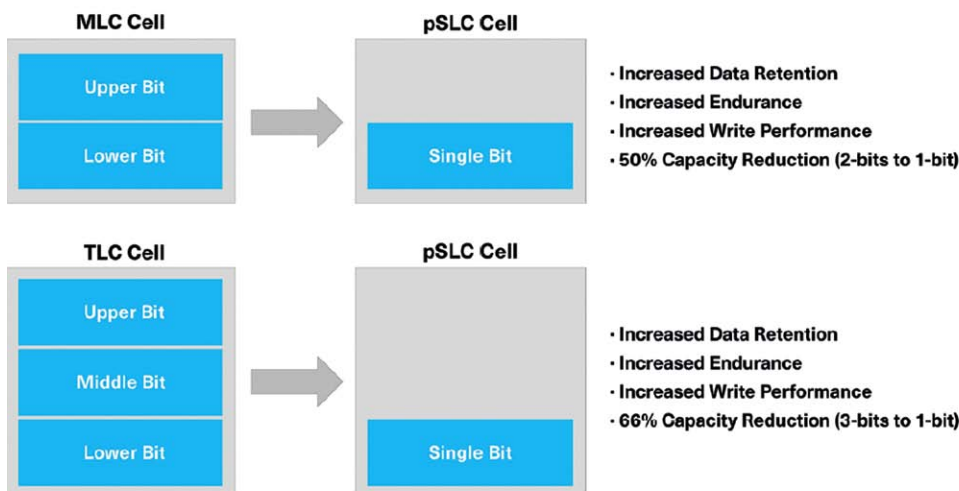

Figure 3: pSLC (enhanced user data area) uses only one instead of two (MLC) or three (TLC) bits per flash cell. This increases data retention, longevity, and performance of the memory – but negatively impacts capacity.

Wi-Fi 6 and Wi-Fi 6E – the latest Wi-Fi standards

# Fit for current and future requirements

*The latest Wi-Fi standard, Wi-Fi 6, and its extension, Wi-Fi 6E, promise high data transmission speeds, higher capacity, and low latency, even in environments with many network subscribers. These advantages open up numerous new application options and areas of use, but also give rise to new requirements.*

BY KERSTIN NASER,  
CORPORATE PRODUCT MANAGER WIRELESS  
AT RUTRONIK

The much-cited refrigerator that automatically orders food has not caught on, but many other smart home devices have, such as washing machines that inform their owners via smartphone that the laundry is done. This is made possible by Wi-Fi, one of the best-known and most widespread wireless technologies. More and more devices offer a Wi-Fi interface, and not just in the smart home sector. Wi-Fi is also increasingly finding its way into industrial environments through applications such as mobile robots, crane systems, automated guided vehicles, or even safety and security systems and the networking of sensors in production lines. Virtual reality and gaming applications as well as wall-boxes also use this wireless technology.

The new application areas also place new requirements on the technology; and despite the increasing number of subscribers in the Wi-Fi network, users expect a stable network connection. That is why the Wi-Fi Alliance is constantly further developing the standards. Since the first IEEE 802.11 protocol appeared back in 1997, data throughput has improved significantly with each new Wi-Fi standard.

This time, however, the Wi-Fi Alliance has not only optimized the technology, but also the naming: Wi-Fi 6 and Wi-Fi 6E (E = enhanced/extended) replace the cumbersome title IEEE 802.11ax. The predecessor standards have also been given new names: IEEE 802.11ac is now called Wi-Fi 5 and IEEE 802.11n is now Wi-Fi 4.

Technically speaking, Wi-Fi 6 and Wi-Fi 6E offer a whole range of enhancements:

- OFDMA (orthogonal frequency division multiple access): OFDMA is an extension of the OFDM method used in Wi-Fi 5 technology. While only one data packet can be transmitted to a single terminal within a given time window when using OFDM, OFDMA enables the transmission of multiple sets of data for various terminals in the same data packet. This increases data rate efficiency and reduces network latency significantly.
- 1024-QAM (quadrature amplitude modulation): Compared to Wi-Fi 5, which uses the 256-QAM modulation method, 1024-QAM allows a 25% higher data throughput with Wi-Fi 6. With 1024-QAM, a total of 10 bits can be transmitted; with 256-QAM, it is only 8 bits. This is particularly advantageous

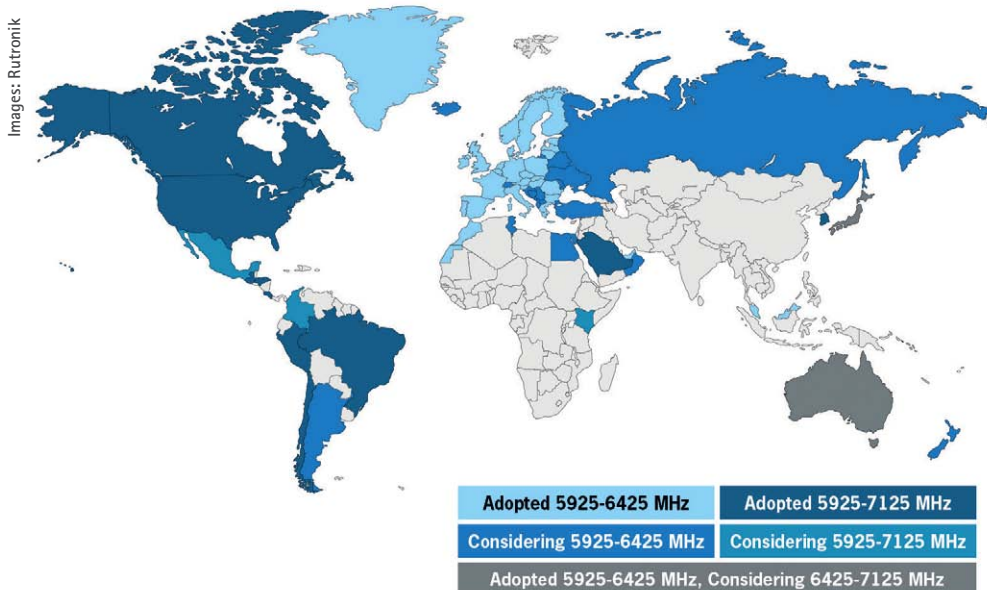

Figure 1: Countries where Wi-Fi 6E is supported (as of: April 2022).

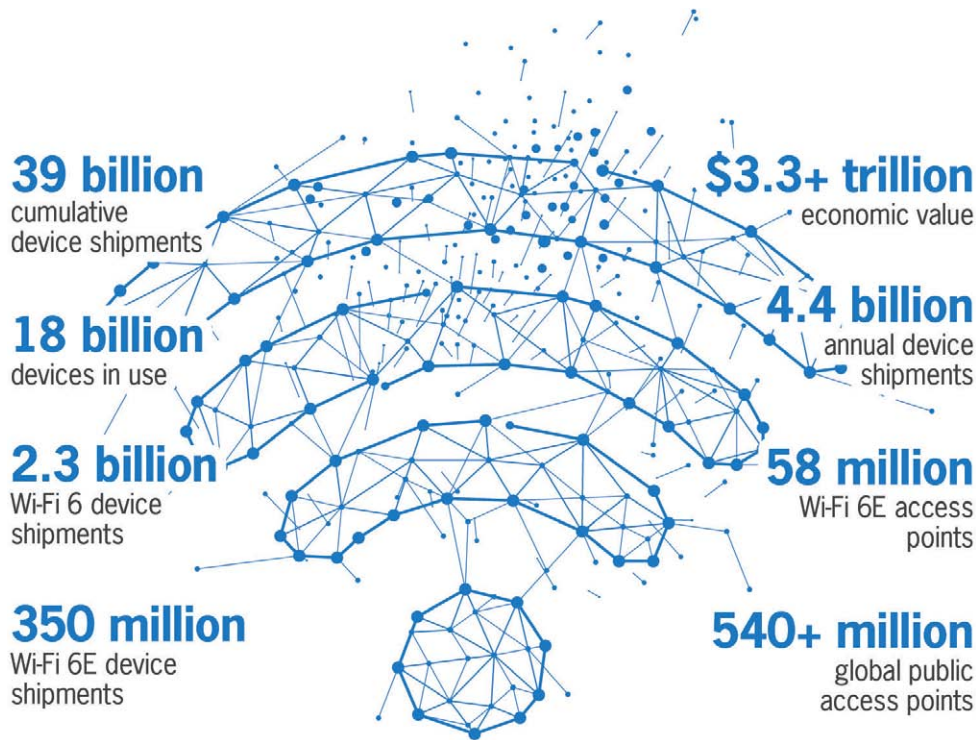

Figure 2: Wi-Fi is a market with billions of devices and an economic value currently estimated at \$3.3 trillion. (Data source: Wi-Fi Alliance)

in environments characterized by a high density of WLAN terminals, for example in railroad stations or at large events.

- **MU-MIMO (multi-user - multiple input, multiple output):** By breaking up the available bandwidth into separate spatial streams, communication via multiple antennas between an access point and multiple devices is possible simultaneously, both downlink and uplink. With Wi-Fi 5, this only worked for downlink. As a result, Wi-Fi 6 further reduces network latency and provides greater stability.
- **TWT (target wake time):** TWT "wakes up" network subscribers to transmit data only at specific times. The rest of the time, the devices "sleep" and thus require less energy. This also avoids interference in the network communication, since sleeping subscribers do not transmit data and do not block the communication streams – a decisive plus point, especially in industrial automation with many sensor applications.
- **BSS (basic service set) coloring:** Each BSS, consisting of an access point and the clients, is assigned a "color" (i.e. a number) as soon as another BSS is in its vicinity. Signals from another network can therefore be detected and ignored. This allows more efficient use of the streams and better transmission quality.

- **Security standard WPA3 (Wi-Fi Protected Access 3):** Compared to its predecessor standard WPA2, WPA3 provides significant enhancements in the area of authentication and encryption, as well as in the configuration of WLAN devices. Moreover, it ensures greater security at public hotspots. The WPA3 standard is mandatory for Wi-Fi 6 certified products.

*Wi-Fi 6E offers even more advantages*

Wi-Fi 6E offers more than just the aforesaid advantages: extension to the 6 GHz band, for instance.

Wi-Fi 6E is also based on the IEEE 802.11ax Wi-Fi standard, thus supporting all the technologies mentioned, just like Wi-Fi 6. However, only the now heavily congested original 2.4 GHz and 5 GHz bands are defined for Wi-Fi 6. In contrast, the 6 GHz band is also available with Wi-Fi 6E. Further 80 MHz and up to seven additional 160 MHz spatial streams for data transmission allow even higher data throughput with wider spatial streams. The 2.4 GHz and 5 GHz bands, which devices with older Wi-Fi standards use for transmission, are relieved, which in turn leads to lower latency. This makes Wi-Fi 6E an ideal solution for gaming, streaming, and virtual reality applications.

However, Wi-Fi use of the 6 GHz band has not yet been opened up in some countries. The USA started in 2020; Fig. 1 shows which other countries have since followed its lead.

*Switching over requires new hardware*

Anyone who is now considering switching to Wi-Fi 6 or Wi-Fi 6E should keep in mind that devices with older Wi-Fi standards cannot simply be upgraded to Wi-Fi 6/6E through a software update. This means that all routers and devices that need to use the latest standard must be equipped with new hardware. Wi-Fi 6/6E devices, on the other hand, are backwards compatible with older Wi-Fi standards.

Rutronik already has products from various suppliers in its portfolio for both Wi-Fi 6 and Wi-Fi 6E:

Intel offers combination cards for Wi-Fi 6 and Bluetooth with its AX200 and AX201 models in form factors M.2 2230 and M.2 1216. Wi-Fi 6E cards are also already available with the two M.2 cards AX210 and AX211 from Intel. All Intel plug-in cards can be obtained in a range of variants, both with and without vPRO. AX210 is additionally offered for the industrial temperature range. Development kits are also available.

Silex offers a Wi-Fi 6 and Bluetooth 5.2 BR/EDR/LE card. SX-PCEAX is based on Qualcomm's QCA2066 SoC and is available in various form factors (SMT, half-size PCIe, M.2). The module is also certified for the 6 GHz band for Wi-Fi 6E.

Advantech has several Wi-Fi 6 plug-in cards in its product range: AIW-163 is an M.2 2230 card with an A-E Key (the key describes the connection form of the M.2 header) and a temperature range of 0°C to 70°C. AIW-165 in form factor M.2 2830 has an E Key and a temperature range of -40°C to +85°C. Advantech has announced two more M.2 2230 E Key cards for late 2022. Kits are also available from Advantech.

Module supplier Murata relies on chip sets from Infineon/Cypress and NXP for its Wi-Fi 6 and 6E products. Type 1XL is an NXP-based Wi-Fi 6 and BLE 5.2 2x2 MIMO module in a small form factor of 19.1 mm x 16.5 mm. More modules will be launched from the beginning of 2023: Type 2EA is based on the Cypress CYW55573 and will support Wi-Fi 6E.



Type 2DL/2DR and 2EL/2ER are based on different NXP chips. The 2Ex variants also support Thread in addition to Bluetooth and Wi-Fi 6. The 2xR modules feature an extra antenna for Bluetooth.

Panasonic will also launch its first Wi-Fi 6 modules in 2023.

Rutronik offers complete routers with the new Wi-Fi 6/6E standard from Asus; and Silex also plans to add Wi-Fi 6E to its wireless bridges, device servers, and wireless presentation systems.

---

*Established standard*

---

Products are, therefore, available and numerous device suppliers are already applying them. According to information from the Wi-Fi Alliance, 2.3 billion and 350 million of the total 29 billion Wi-Fi devices shipped in 2022 will be equipped with Wi-Fi 6 and Wi-Fi 6E respectively (Fig. 2). Thanks to their advantages, the overall share of the new standards will certainly increase significantly.

While Wi-Fi 6 and Wi-Fi 6E are establishing themselves on the market, the Wi-Fi Alliance is already working on the next standard: Wi-Fi 7 or IEEE 802.11be. Users can look forward to three bands (2.4, 5, and 6 GHz) and even higher data transfer speeds. However, the Wi-Fi Alliance will not finalize this standard until mid-2024. So, it will be quite some time before hardware with Wi-Fi 7 is available on the market. ■

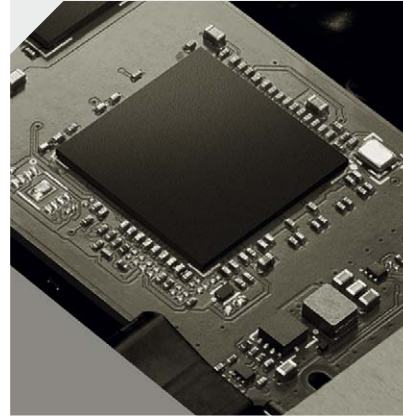

## D3 Series

Formerly manufactured by Intel Corporation

Our SATA family of TLC NAND SSDs accelerates storage performance and reduces operating expenses (OpEx) on legacy infrastructure. The SSD D3 Series includes a wide range of products tuned for mixed read/write and read-intensive workloads.

## D7 Series

Formerly manufactured by Intel Corporation

Our highest-performing family of TLC 3D NAND SSDs, the Solidigm D7 Series delivers an optimal balance of speed, endurance, and capacity tuned for real-world mixed and performance-sensitive read workloads.



## P41 Plus Series

The P41 Plus delivers cutting-edge PCIe Generation 4 storage for personal computers. Use it with Solidigm Synergy™ software for optimal performance and value.

Bluetooth LE Audio

# Better listening experience

*Bluetooth LE Audio (low energy audio) has the potential to fundamentally change our audio experience, whether through “silent disco” or improved listening with an assistive listening system. Due to further developments, a variety of novel use cases and products, including new markets, are expected to emerge in the world of audio.*

BY JANINE REHBERG,  
CORPORATE PRODUCT MANAGER WIRELESS  
AT RUTRONIK

**B**luetooth technology has been under development since the 1990s and uses over 79 channels in the 2.4 GHz unlicensed band to transmit data. Today, the Bluetooth Classic variant only supports point-to-point communication for audio transmission.

A key further development is Bluetooth Low Energy (LE). It has already replaced Bluetooth Classic in most applications. Wireless audio streaming, e.g. for wireless headphones, speakers, or in-car entertainment systems, is now the last bastion of Bluetooth Classic (Fig. 1).

Bluetooth LE also uses the 2.4 GHz band, but – as the name suggests – is designed to operate with low energy. Beside point-to-point communication, it also enables broadcast and mesh topologies, thus laying the foundation for large-scale, high-speed device networks. Furthermore, it can be used for device tracking, making it an ideal addition to indoor GPS.

## Focus on audio

The focus of the latest standard is also crystal clear: it is called Bluetooth Audio. The first version is based on Bluetooth Classic. However, its range of functions is limited as is the variety of possible applications. The second version, the new Bluetooth LE Audio, in contrast, enables the more flexible processing of audio signals. This represents an evolutionary step for existing applications, such as headphones and hearing aids, thereby creating new applications and markets for audio streaming.

LE Audio is based on Bluetooth LE and the power-saving Low-Complexity Communications Codec (LC3) developed by the Fraunhofer Institute. It combines higher audio quality than Classic Audio with low data rates and

provides developers with an enormous amount of flexibility (Fig. 2). Moreover, various product features can be better matched, e.g. the provided energy savings can be used either to extend the battery life or to use smaller batteries.

LE Audio offers a range of interesting functions: With Multi-Stream Audio, multiple independent audio streams can be played synchronously between an audio source device and one or several audio receiving devices (audio sink function). This optimizes their performance significantly. For example, this results in a better stereo experience for wireless earphones. Users can also switch between various voice assistants just as seamlessly as between different audio source devices.

The Auracast function also allows users to send one or several audio streams from one audio source device to numerous audio sink devices. In contrast to the multi-stream function, however, the number of audio sink devices is unlimited here. This opens up an entirely new set of use cases for sharing audio experiences.

When an Auracast transmitter, such as a TV, smartphone, laptop, or similar, begins a broadcast, it contains one or several audio streams (e.g., left and right stereo stream) and an advertisement with information about the broadcast, such as name, content, codec configuration, etc. Auracast assistants, also Auracast-compatible smartphones, smartwatches, or assistive listening systems (ALS), scan for these advertisements. Users can then select a broadcast to join via their user interface (UI) – similar to connecting to a WLAN today. Once a broadcast has been selected, the Auracast assistant provides the receiver (e.g. headphones or earbuds) with the information it needs to join the broadcast.



The DNA of tech.™

# VSMA10 Astral Series

## High Power Infrared Emitting Diode

The SurfLight™ portfolio includes multiple surface-mount infrared emitters. It features a double stack emitter chip for highest radiant power

### KEY FEATURES

- Centroid wavelengths of 850 nm and 940 nm
- Three angles of half intensity available:  $\pm 28^\circ$ ,  $\pm 40^\circ$  and  $\pm 60^\circ$
- Double-stack chip for high radiant intensity up to 6,000 mW/sr
- Ambient temperature range  $-40^\circ\text{C}$  to  $+125^\circ\text{C}$
- Low thermal resistance 6 K/W to 9 K/W
- High drive currents: up to 1.5 A (DC) and up to 5 A (pulsed)



### APPLICATIONS

- **Industrial and Consumer**
  - CCTV
  - machine vision
  - gaming
  - eye tracking
  - toll systems
  - number plate recognition
- **General IR illumination**
- **Automotive**
  - driver monitoring
  - occupant detection

Figure 1: The images and graphics clearly show the extended options and improved features of Bluetooth LE compared to Bluetooth Classic.



The global standard for simple, secure device communication and positioning

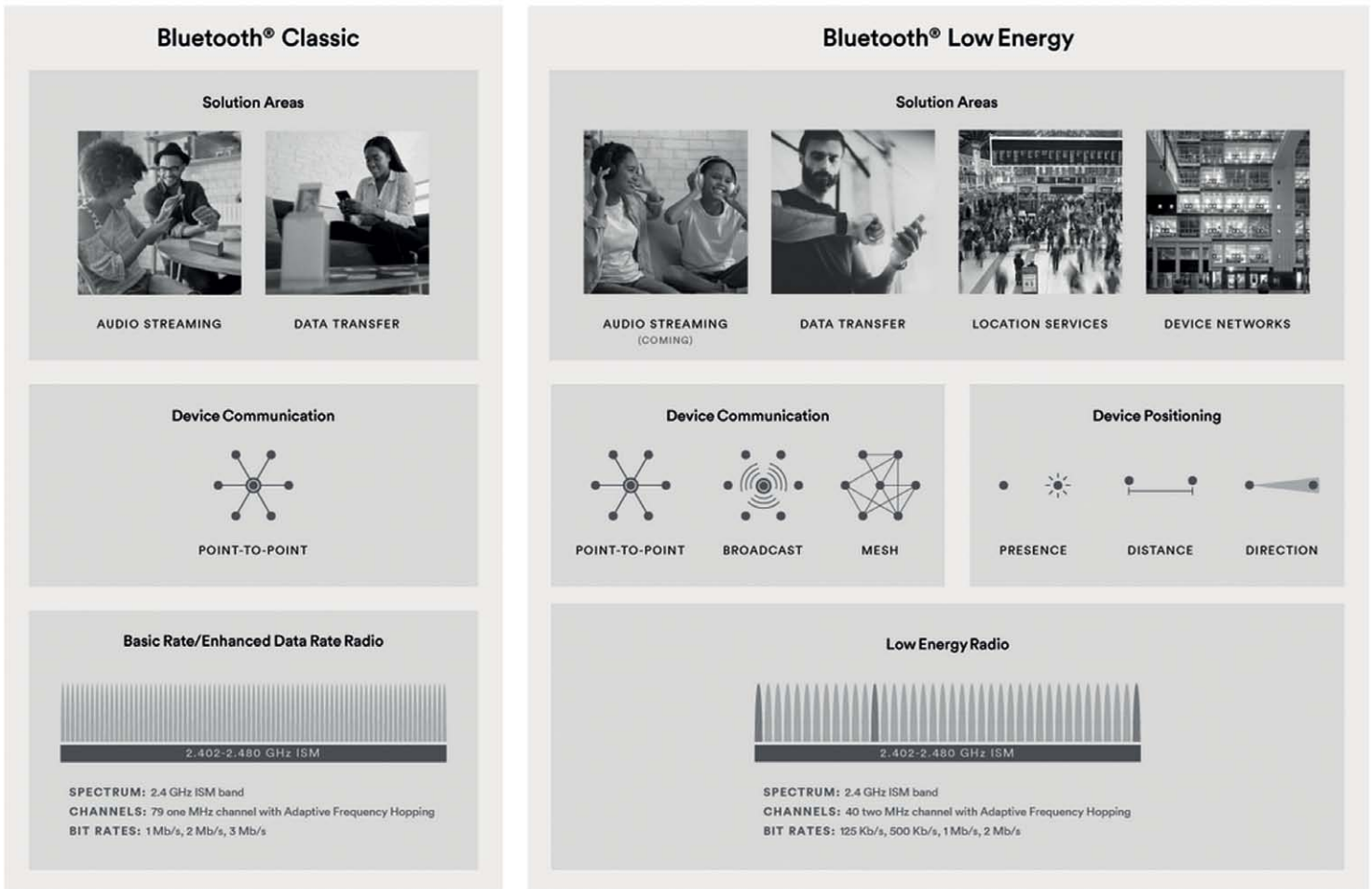

With personal audio sharing, people will be able to share music and podcasts with others around them; for example, via their smartphone with family and friends within Bluetooth range. In the public sphere, for example, airports, railroad stations, bars, gyms, cinemas, and conference centers can share information or music with their visitors via Bluetooth Audio. This gives people the opportunity to enjoy the same music – on a larger scale even at “silent” concerts or discos.

It also allows people to use their own earbuds or ALS to select the audio being broadcast by silent TVs, for example in a gym or waiting room, and to listen to a conference lecture, a talk, a church service, or a guided museum tour, and ensures they do not miss any announcements at an airport. And since several audio streams can be sent in parallel, multiple languages can be transmitted, for example. This is particularly interesting for lectures, conferences, and airport announcements.

*ALS applications*

LE Audio will guarantee significant benefits for people with assistive listening systems. They benefit not only from significantly higher audio quality than with traditional hearing aids, but can also use their Auracast-enabled ALS as wireless headphones, e.g. when using their smartphone. This helps to eliminate interference during a call, something that often occurs when the phone is held up next to the ALS. This can be achieved with a simple topology (Fig. 3, left).

The connection between phone and hearing aid is established through an audio stream, which also allows a return stream. The user can then use the microphone of either the hearing aid or the phone as the return channel. Since both directions of the audio stream are configured and controlled separately, both can also be switched on and off individually.

In the topology (Fig. 3, right), the phone sends a separate left and right audio stream to the ALS in the left and right ear, respectively. Compared to the connection with an audio stream that then also establishes a second wireless connection with the other ear, latency is thus significantly reduced. This is evident when it comes to the lip synchronization of movies or music videos, etc.

The return streams can also be implemented separately, which further adds to the complexity. These parallel, synchronized streams to two independent audio devices go far beyond what conventional Bluetooth audio profiles can handle.

*Hardware for new listening experiences*

Despite being based on Bluetooth LE, LE Audio still requires its own hardware. Nordic Semiconductor offers the nRF5340, an all-in-

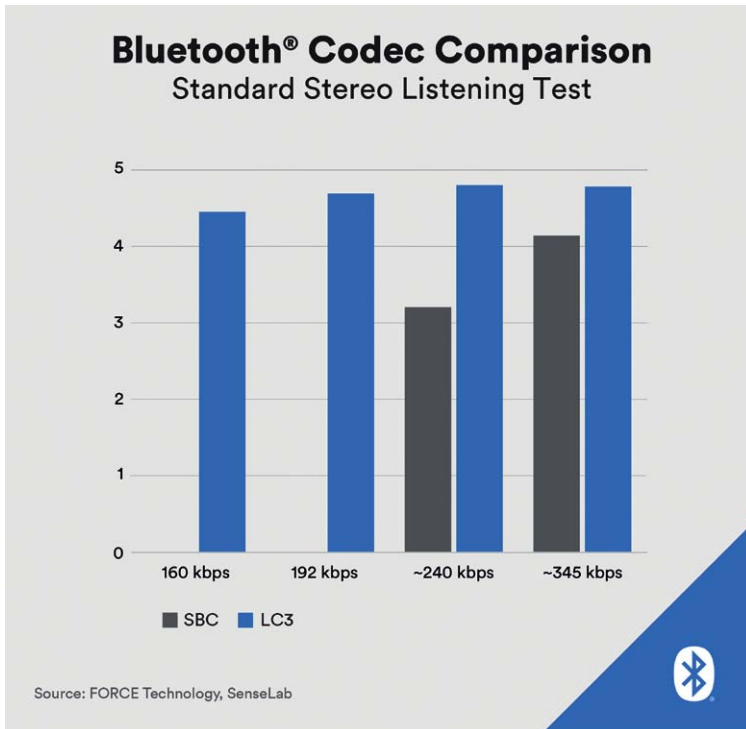
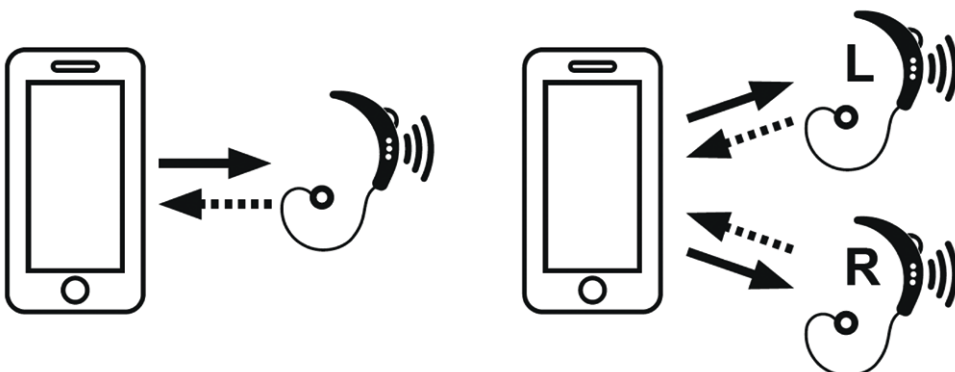

Figure 2: LC3 (Low-Complexity Communications Codec) ensures better audio quality at every data rate than SBC (Low-Complexity Subband Codec) on which Classic Audio is based.

one SoC (system-on-chip), which is ideally suited for Bluetooth LE Audio applications, thanks to its dual-core processor – consisting of the 128/64 MHz Arm Cortex-M33 application processor with 1 MB flash memory and 512 kB RAM, and the 64 MHz Arm Cortex-M33 network processor with 256 kB flash memory and 64 kB RAM – and an extended temperature range of  $-40$  to  $+105^{\circ}\text{C}$ .

For an even easier entry, Nordic has come up with the nRF5340 Audio Development Kit (DK). It supports all Auracast functions and is configurable. As a USB dongle, it can send or receive audio data from a PC; further, it can be used as a business headset or as true wireless stereo (TWS) earbuds. The Audio DK essentially consists of the nRF5340 SoC, the nPM1100 power management IC, and Cirrus

Figure 3: With Auracast, an ALS can be used as a headphone, either with one audio stream or with two separate streams for the left and right ALS.



Logic's CS47L63 audio digital signal processor (DSP), which is optimized for direct connection to an external headphone load and is ideal for mono-only and direct speaker output earphones.

Also based on the nRF5340, Nordic has developed Thingy:53 with the support of Rutronik. The multi-sensor prototyping platform with multi-protocol short-range wireless connectivity ensures reduced time to market for embedded applications with machine

learning (ML). Thingy:53 is equipped with multiple motion and environmental sensors, the nPM1100 power management IC, the nRF21540 front-end module, a power amplifier/low-noise amplifier, and a 1350 mAh Li-Poly battery. This allows embedded ML models to be run directly on the device to use the sensors for speech recognition, for example. Certain motions or sounds wake nRF5340 from stand-by mode, leaving the platform in power-saving sleep mode for a long time.

Moreover, Rutronik's product portfolio also includes modules based on Nordic's nRF5340 chip. Insight SiP's ISP2053, for example, integrates semiconductor and passive components, including the antenna structure, into a miniaturized module measuring just  $8\text{ mm} \times 8\text{ mm} \times 1\text{ mm}$ , thanks to its system-in-pack-

age (SiP) method. It is, therefore, ideal for applications that offer very little space. The module is fully certified and supports not only Bluetooth Audio but also all other profiles of Bluetooth LE, Long Range, and Mesh, as well as NFC, Thread, ZigBee, and direction finding using AoA/AoD (angle of arrival and angle of departure). Starting with Bluetooth 5.0, all Insight SiP pin-compatible modules will facilitate migration to the latest Bluetooth generation.

Users who do not require the compact design of the Insight SiP module may find MS45SF1 from Minew to be a competitively priced alternative. As an officially licensed design partner of Nordic, Minew also uses nRF5340 for MS45SF1. The module comes with an integrated PCB antenna and is also fully certified.

### Summary

Bluetooth LE Audio is blazing a trail to a new, completely networked audio world of headphones, earbuds, or ALS, as well as smartphones, laptops, TVs, and other audio devices. The introduction of native LE Audio support in Android 13 will certainly boost the interest of audio device suppliers in the new Bluetooth version. In its "Bluetooth Market Update 2022", the Bluetooth SIG expects strong growth in earbuds and headphones through LE Audio and forecasts the sale of more than 600 million devices by 2026. Last but not least, Bluetooth LE Audio will, without doubt, have a massive impact on the current market for ALS and auditory acoustics. The further development ensures affordable hardware with the option of audiogram adjustment, such as frequency (equalizing) and phase correction. And everything is simply controlled via a phone app. ■



intel.  
vPRO  
i7

intel.  
vPRO  
i5

intel.  
CORE™  
i7

intel.  
CORE™  
i5

intel.  
CORE™  
i3





Intel® NUC 12 Pro Mini PCs, Kits, & Boards

# Small Size. Big Business Performance.

Boost business performance with 12th Gen Intel® Core™ processors and the latest features to support productivity, collaboration, and edge compute

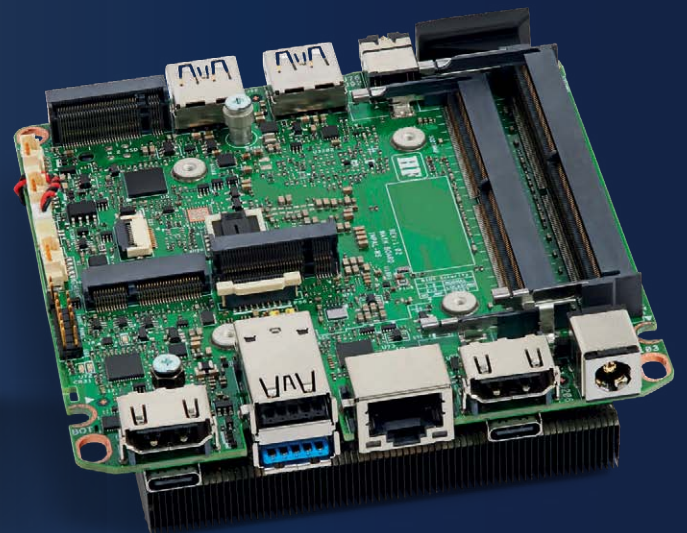

Display technology

# ePaper displays stepping into a new color dimension

*Dynamic labeling is easy, energy efficient, and cost-effective with ePaper displays. However, a (full) color display has been limited, until now.*

*N color technology is now changing all that and opening up whole new application areas for these displays.*

BY DIRK TROELENBERG,  
CORPORATE PRODUCT SALES MANAGER  
DISPLAYS AT RUTRONIK, AND  
ZHEN LIU, BUSINESS DEVELOPMENT  
MANAGER AT HOLITECH EUROPE

ePaper displays are very different from other technologies such as LCD, TFT, and (O)LED. They have their advantages but also their limitations. Due to their operating principle, ePaper displays offer viewers a contrast ratio similar to that of paper and excellent, flicker-free readability from any viewing angle (180°), even in direct sunlight. Further, power consumption is extremely low compared to other technologies, as the displays only need power when the displayed content is refreshed. This means the display remains totally visible even when the current and voltage are zero. Depending on the actual size of a display, only a few microwatts of power are required to refresh the content.

ePaper displays are, therefore, ideal for battery-powered and wearable (IoT) applications. Current applications include supermarket shelf labels and price tags featuring product information. The evolution of ePaper from monochrome to color display is giving this technology a whole new boost.

*New application areas thanks to full-color display*

N color ePaper displays from Holitech are based on all-in-one IC technology and are able to provide a color image with seven basic colors even without the use of a color filter. The displays comprise micro-capsules. Each of these capsules contains four color particles (magenta, yellow, cyan, and white) dissolved in a transparent liquid. The color pigments are charged differently: yellow, cyan, and white negative, magenta positive. By applying a specific voltage, each micro-capsule displays a corresponding combination of the color particles and thus a specific hue (Fig. 1).

The individual pixels are controlled by means of matrix displays. If different voltages are applied, the corresponding color capsules move to the surface, where they become visible to the viewers (Fig. 2). Combining the seven basic colors (red, green, blue, cyan, magenta, yellow, white) enables the display of colored images. The first available N color ePaper display is 7.3" tall and has a resolution of 800 × 480.

*Extensive application areas despite physical limits*

ePaper displays have two limiting factors that are decisive for their application areas. First off, the operating temperature for ePaper is limited. For a black/white ePaper, it ranges from 0°C to 50°C, and for the N color version, from 15°C to 35°C. This is due to the physical properties of the micro-capsules. Outside this temperature range, ePapers do not work properly or might even be

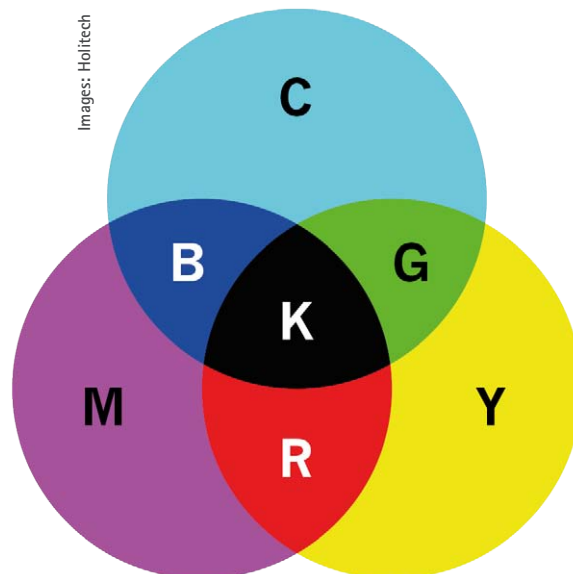

Figure 1: By using four color particles, N color displays can show seven basic colors.



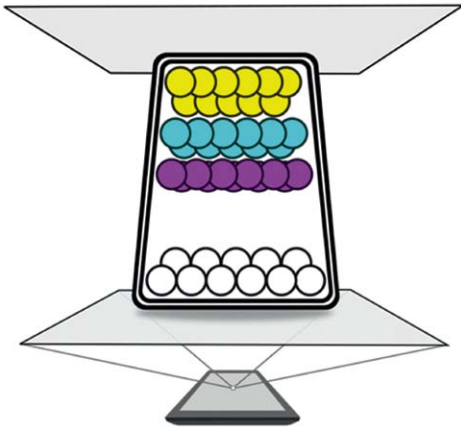

Figure 2:  
Capsules filled with color pigments move to the surface depending on the voltage applied, resulting in a colored image.

damaged. Outdoor applications are, therefore, only possible to a limited extent; heating is highly recommendable at temperatures below  $-20^{\circ}\text{C}$ . Moreover, direct exposure to UV light has a negative impact. The sun's rays dry out the ink capsules and cause irreparable damage. However, UV blocking films offer a quick-fix solution.

The second limitation is the relatively sluggish content refresh rate as a result of particle rearrangement. The full refresh rate for complete renewal of image information is in theory 28 seconds, but in practice it is significantly less. N color technology is, therefore, well suited for displaying information that does not have to be refreshed regularly.

Retail, logistics, and industry are already benefiting from this cutting-edge display option. Typical applications include electronic shelf labels (ESL) and price tags that are controlled from a central location via a bus system, for example in supermarkets or warehouses where labels need adjusting from time to time due to changing stock or products. Smart home and IoT applications are also an obvious choice for ePaper displays. For example, they can be used to indicate the occupancy of meeting rooms or rooms in hospitals, or to display passenger information and schedules in railroad stations and on public transport.

The full-color display will also open up new application areas for ePaper displays, for ex-

ample as menus in restaurants. They are usually made of high-quality paper, and even minor changes result in a lot of reprinting. When using N color displays, it is easy to update and adjust prices, menu details, and ingredient information electronically. Further, the dishes and drinks available can be shown both pictorially and in written format on the display. Needless to say, the new full-color ePaper displays will inspire designers to come up with whole new ways of using them. ■

Advertisement

**SAMSUNG**  
ELECTRO-MECHANICS



## THE SMARTEST SOLUTIONS FOR YOUR APPLICATION

- High Quality MLCC
- Automotive MLCC
- Industrial MLCC
- High Cap / High Volt MLCC
- Commercial Grade MLCC
- Up to 5mm bending strength



Aid with selecting the right EEPROMs

# Connected to the memory correctly

*Their space and energy-saving properties make EEPROMs the ideal choice for mobile devices and IoT applications. They are also essential when using serial presence detect in the memory modules of computers. The key factor here is selecting the best EEPROM to meet the specific requirements.*

BY THOMAS BOLZ, CORPORATE PRODUCT  
MANAGER STANDARD PRODUCTS  
AT RUTRONIK

Interest in wearables and IoT applications continues to grow. Mobile devices keep getting smaller and their service life and standby times longer. These phenomena are also reflected in the development of digital memory modules: Performance, storage density, speed, and service life are all increasing while power consumption is falling. Due to their reduced size and relatively low operating current, flash memories and EEPROMs (electrically erasable programmable read-only memories) are now the most commonly used memory chips for IoT, wearables, etc.

EEPROMs are semiconductor memories consisting of interconnected field-effect transistors with floating gates (Fig. 1). They are extremely small, can be operated at low voltages, and consume very little power. Further, they enable multi-byte operation and have a reduced number of pins.

The memories are programmed by charging the floating gate of the transistor (Fig. 2). The written data are represented by a bit pattern of charged and uncharged gates. They can be

read as often as required via the drain-source connections of the transistors, with the normal operating voltage well below the programming voltage during the actual reading process.

EEPROMs are non-volatile memory modules. The typical retention period of the stored

data is upwards of ten years. However, it takes much longer to program an EEPROM than a flash memory, since the data are written or erased byte by byte and not as whole blocks of data. The advantage: Developers can focus their full attention on certain parts if need be. Only an external power supply is required, as the higher voltage necessary for programming/erasing is generated internally. Maximum endurance cycles typically vary between 10,000 and 1,000,000.

EEPROMs are used wherever smaller data volumes need to be stored and kept available for greater intervals over longer periods of time. In addition to call number memories in phones, they can also be found in memory cards and microcontrollers, for instance. Other applications include SSDs, BIOS (basic input/output system) in computers, or RAM memory modules, where they retain configuration data or parameters required for operation.

## Serial and parallel interface types

EEPROMs are available in two classes. Models with serial access are very small and cheap, and account for roughly 90% of the total EEPROM market. They are predominantly found in standard applications, since, unlike parallel EEPROMs, they are slower and have a lower storage density, typically of between 256 bit and 256 kbit.

In contrast, parallel modules have a higher storage density ( $\geq 256$  kbit). They are generally faster and guarantee a long service life and extensive reliability. Unlike serial EE-

### EEPROM Memory Cell Configuration

Consists of 2 transistor cells.

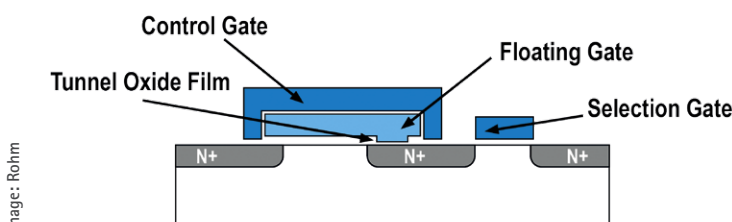

Image: Rohm

Figure 1: An EEPROM cell consists of two transistors with a floating gate.

Image: Rohm

### Data Write Method

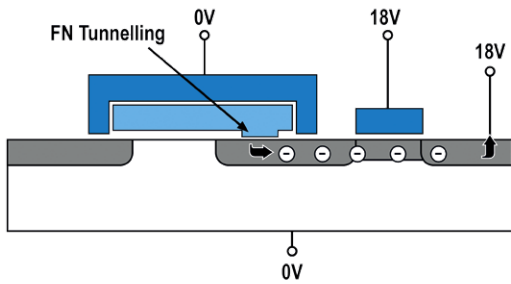
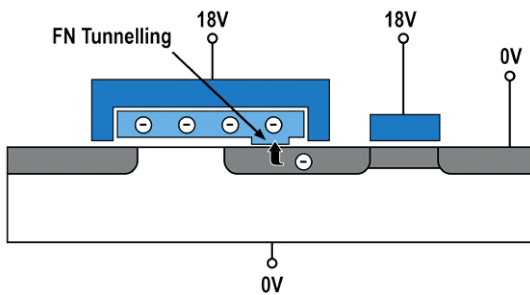

Figure 2: The memories are programmed (above) by charging the floating gate. If necessary, a larger voltage pulse (below) can be applied to clear the charge. The written data are represented by a bit pattern of charged and uncharged gates.

### Data Erase Method



PROMs, a higher pin count of 28 or more is required, making them somewhat larger – usually too large for the ever-smaller end products.

Making a decision between serial and parallel modules is therefore a trade-off between cost, available space, and memory density. However, the operating temperature and operating voltage as well as the required minimum or maximum voltage also need to be taken into account when selecting the right memory.

Generally speaking, EEPROMs support SPI, I<sup>2</sup>C, and Microwire interfaces. Data throughput, availability, and power consumption of the system are the crucial points here. SPI enables speeds of up to 20 MB/s and is the preferred solution for high-speed applications, but requires four wires for communication instead of just two like I<sup>2</sup>C (with 400 kB/s to 1 MB/s). When using I<sup>2</sup>C, fewer MCU ports are required as multiple EEPROMs can be connected to the same bus. Microwire is slower than SPI and only available with smaller memory capacities. This solution also requires four wires.

.....

### *Memory modules for PC main memories*

.....

Computers perform a self-test each time they are switched on. This includes automatic detection and configuration of the installed hardware. Serial presence detect (SPD) is information stored in an EEPROM on an SDRAM memory module that tells the BIOS about the module's

Advertisement



# Supercharged Solutions for EV Charging Stations



**Scan the QR code**  
to download our  
**EV Charging Application Guide**



SDR (SDRAM)	DDR (SDRAM)	DDR2 (SDRAM)	DDR3 (SDRAM)	DDR4 (SDRAM)
168 Pins / 3,3 V	184 Pins / 2,5 V	240 Pins / 1,8 V	240 Pins / 1,5 V	284 Pins / 1,2 V

Table 1: Comparison of the various DIMM modules

Density	Part Number	Vcc	Clock Frequency	Package	Support Module	Product Status
2 kbit	GT34C02B	1.7–5.5 V	1 MHz	TSSOP/UDFN	DDR2/DDR3	MP
	GT34TS02B	2.2–3.6 V	400 kHz	TSSOP/UDFN	DDR3	MP
4 kbit	GT34C04	1.7–5.5 V	1 MHz	TSSOP/UDFN	DDR4	MP
	GT3TS04A	2.2–3.6 V	1 MHz	TSSOP/UDFN	DDR4	MP

Table 2: SPD/TS product line from Giantec

capacity, data width, speed, voltage, etc. The BIOS uses this information to configure the memory properly for maximum reliability and performance. Correct communication between the processor and memory would not be possible without SPD.

A dual inline memory module (DIMM) is a memory chip equipped with a certain type of SDRAM memory module and serves as the main memory in PCs, servers, and other devices. DIMMs consist of one or several random access memory (RAM) chips and a small circuit board that connects them to the computer motherboard. The data bus is based on 64 bit.

An extensive range of DIMMs is available. All of them measure the same length but are not compatible with each other. The modules differ in terms of their operating voltage, number of contacts, and coding notches. They are designed to prevent modules of different memory types (SDR, DDR, DDR2, DDR3, etc.; see

Table 1) being accidentally inserted into the wrong slot.

*DDR SDRAM and the variants  
DDR2, DDR3, DDR4*

The abbreviation DDR SDRAM stands for double data rate synchronous dynamic random access memory. The semiconductor memory is used not only in computers but also in motor vehicles, networks, medical technology, and consumer electronics. The variants DDR, DDR2, DDR3, and DDR4 SDRAM differ in terms of their data transfer rates, clock cycles, and number of contacts.

Compared to conventional SDRAMs, the transfer rate of the memory is much higher. This is possible due to the double data rate (DDR): For example, when transmitting data, both the rising and the falling edge of the clock signal are used for data transmission. This basically doubles the band width.

Further, each SDRAM memory module has a digital data sheet to ensure the motherboard can carry out the necessary memory controller settings. It is saved in the SPD EEPROM and read by the BIOS. The information contained therein is elementary for configuration of the memory controller.

*Ultra-low-power EEPROMs  
for wearables and other IoT applications*

The demand for EEPROMs is increasing all the time, especially in the field of IoT applications. In this case, small devices with small batteries that offer the longest possible standby time and service life are crucial. This obviously requires low power consumption and low operating voltage. The solution is provided by compact ultra-low-power EEPROMs.

Giantec Semiconductor offers a wide range of reliable products. With more than three billion EEPROMs sold to date, the firm ranks third globally, and first in Asia. The reason for this level of success is the high-quality models. They offer a standard standby current of  $I_{sb} < 200 \text{ nA}$ , and the maximum working current is only  $300 \text{ }\mu\text{A}$ . The battery life can be further enhanced by switching off the EEPROMs when they are not being used by the PIO (Programmable I/O). Giantec offers EEPROMs for I<sup>2</sup>C, SPI, and Microwire interfaces as well as in all standard packages such as PDIP, SOP8, MSOP8, DFN, and WLCSP.

The entire EEPROM GT34 line from Giantec supports DDR2, DDR3, and DDR4 SDRAM. DDR3 and DDR4 also come with Intel certification for DIMM applications. The highly reliable SPD/TS (TS: temperature sensor) product line for DIMMs (Table 2) is available in various package types and with operating voltages ranging from 1.7 to 5.5 V. The EEPROMs offer excellent endurance of one million cycles and data retention of 100 years.

As the sole distributor of Giantec worldwide, Rutronik provides its customers with the best advice and aid in selecting the right product for the respective application from the myriad of options available.

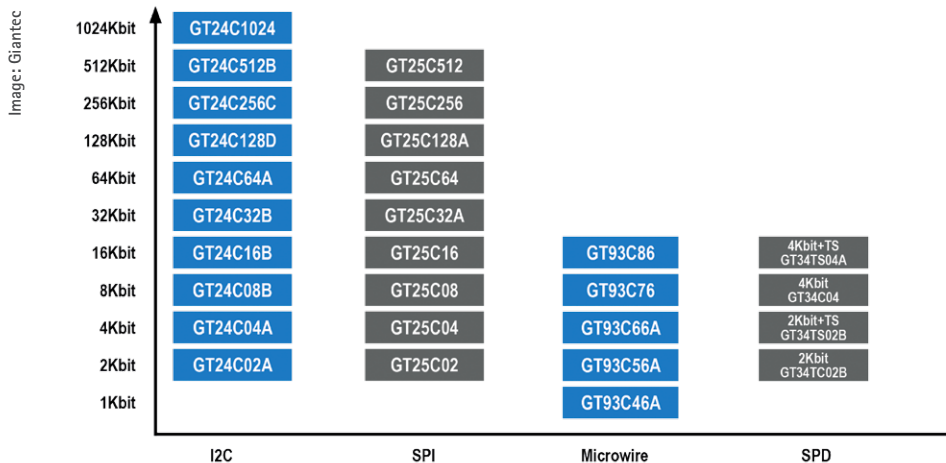

Figure 3: Giantec Semiconductor offers EEPROMs with a range of interfaces, packages, and capacities for varying application areas.

Rutronik System Solutions

# Added value for the entire value chain

*The time when distributors merely acted as reliable logistics providers within the value chain is long gone. Through Rutronik System Solutions, Rutronik is taking this development to new levels. Markus Krieg, Chief Marketing Officer (CMO) at Rutronik, explains what is behind the shift.*

## Markus, what does Rutronik System Solutions stand for?

*Markus Krieg:* We are guided by a question that is central to our customers' business models: How can our customers become and remain valuable partners for their customers? Rutronik System Solutions, therefore, offers its customers an edge in development and highly innovative solutions. To achieve this goal, we combine innovations derived from science and research with our expertise.

## Does this put Rutronik in direct competition with its own customers?

No. We do not deliver finished products but support our customers with proof-of-concepts, meaning concept studies. This helps to accelerate their predevelopment activities and shorten the actual time to market. We also develop proof-of-concepts together with research institutes and universities to export innovation potential to industrial markets.

## What does cooperation between Rutronik and researchers look like in real terms?

We have been able to build up a very large network of university partners in recent years, including the University of Applied Sciences Zwickau, the Chemnitz University of Technology, Pforzheim University, and the Cooperative State University (DHBW) in Karlsruhe. Each university has its own special focus of research, such as power electronics, sensors, and battery management systems. Research is being conducted on incredibly fascinating and trendsetting topics, and we are proud to be able to collaborate with world-leading scientists within these projects.

## What kind of expertise can Rutronik draw on?

We know the requirements and challenges of the industry and are constantly analyzing the market. And we also know the electronics market inside out. We have a broad product portfolio and the corresponding expertise as to which technologies and components and which basic software are best suited for the respective applications, as well as to which components are available today, tomorrow, and in the future. This expertise enables us to translate research findings into marketable and competitive solutions faster and in a more targeted manner. This is how we create our own IP (intellectual property), which is also patent-protected.

## Which proof-of-concepts already exist?

We have compiled an overview of the currently available proof-of-concepts (editor's note: see boxes). Here, we distinguish between four support levels that complement our basic business model: The starting point and foundation is and always will remain our core business as a broadline distributor with the relevant components, technical and commercial support, and our logistics solutions. Level 1 includes advanced technical support at product and system level. At level 2 – the Design Level – we combine development boards from our suppliers and offer appropriately adapted software, thereby creating new system solutions. At level 3 – the Advanced Design Level – we develop our own boards and the associated software. Finally, at level 4 – the Research Level – everything I previously described is brought to full fruition: It is where we offer our own system so-



Markus Krieg, Chief Marketing Officer at Rutronik

“ This expertise enables us to translate research findings into marketable and competitive solutions faster and in a more targeted manner. ”

lutions, which we have developed together with universities and other partners and which are based on our IP. Some of them have already been patented, while others are in the process of being issued.

## Why do patents play such an important role?

They help us protect our intellectual property. It gives us the freedom to disclose our technology and also talk to our customers about the details of our solutions.

## Such design activities require a certain amount of manpower. Where is it located at Rutronik?

We have established design centers in both Lithuania and Singapore, which are currently undergoing expansion. Moreover, we also have a team of developers at our headquarter-

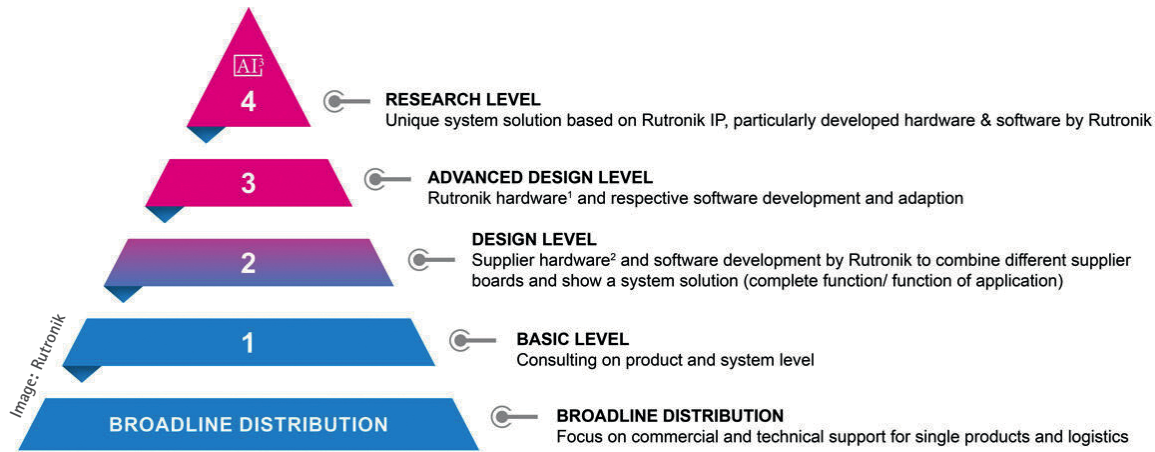

1 Own Rutronik basis platform, Starter Kits and Application modules  
2 Starter Kits, Evaluation Boards, Reference designs

The support and solution pyramid is based on broadline distribution and extends all the way to patented system solutions.

ters in Ispringen. And, needless to say, members of staff work together around the globe with our field application engineers (FAEs). The international team is managed by Stephan Menze, Head of Global Innovation Management. We also have market researchers and analysts in the strategic marketing

team who closely monitor global markets and prepare market studies, enabling us to identify and assess trends at a very early stage. This allows us to keep on identifying new approaches with disruptive potential. So, expect to see a lot more in the future from Rutronik System Solutions.



Discover more about Rutronik System Solutions on the Rutronik website: [www.rutronik.com/innovations](http://www.rutronik.com/innovations)

## FUTURE MARKETS



### OUR VISION TO SHOW THE FEASIBILITY OF INNOVATIVE SYSTEM SOLUTIONS

## Research Level

### Hybrid energy storage system (HESS)

The patented hybrid energy storage system is a joint development of Rutronik and the University of Applied Sciences Zwickau. It is hybrid because it combines the advantages of lithium-ion batteries and supercapacitors (super caps): When operating conventional battery-powered industrial systems in combination with highly dynamic loads, high-frequency current changes with very high current amplitudes are continuously present. HESS can release

or absorb this short-term energy through the highly dynamic charging and discharging of super caps. Only nominal currents are applied to the battery. This intelligent control technique improves the temperature behavior of the overall system and significantly extends the battery life.

### Bidirectional high-voltage circuit breaker

The resettable and low-loss bidirectional HV circuit breaker consists of an isolated 800 V power stage with 12 V measuring

and evaluation electronics and an Aurix TC375 lite kit. The switching stage features high-performance semiconductors of the latest SiC generation from Rohm, high-precision shunts, state-of-the-art optocouplers, and protective components from Vishay. Control is ensured by a second generation Aurix microcontroller from Infineon. By replacing high-voltage relays, the HV circuit breaker reduces copper consumption and increases safety through much faster load disconnection.

# Advanced Design Level

## Development Kit RDK2

The Development Kit RDK2 is a complete package for hardware and firmware development and the basis for a modular toolkit that can be used to create proof-of-concepts in a very short period of time. The board is based on the PSoC 62 microcontroller from Infineon. Thanks to its dual core CPU, it is ideal for secure edge computing and cloud applications. It has an integrated power management IC for SMPS for all connected power supplies. Developers can access all pins of PSoC 62 via supplied headers. The integrated potentiometer can be used for testing the analog-to-digital conversion. In addition, the capacitive sensor technology, CapSense, enables a touch area that can be used as a slider.

The unique butterfly design of RDK2 allows for improved handling, facilitates access to the Arduino connectors, and reduces potential interference from electromagnetic effects. Moreover, RDK2 can be expanded by adapter boards.

## Rutronik Adapter Board – Text To Speech



The Text To Speech adapter board allows HMI applications to be equipped with speech output without expensive studio recordings. This involves connecting an external speaker to a 3.5 mm jack socket. The actual speech output is generated through PC software and controlled by the host microcontroller. This means that only the adapter board and a normal PC are needed. The Text To Speech adapter board can be operated on any evaluation board with Arduino interfaces. The speech output is available in various languages, including English, German, French, Spanish, Italian, Russian, and Chinese (Mandarin).

## Adapter Board HMS Anybus



With this adapter board, HMS Anybus can be used on any evaluation board with Arduino header. The HMS technology is implemented with the AnybusCompactCom B40 plug-on boards and the Connector Board. The board enables communication via all common fieldbus and industrial Ethernet networks, such as EtherCAT, PROFINET, Modbus, POWERLINK, CC-Link, PROFIBUS, plus many more. The system ensures the fastest entry into industrial Ethernet or fieldbus, which can be configured via software.

# Rutronik IP

The following proof-of-concepts are the result of a dissertation research collaboration with a university and contract research with universities and institutions. The unique IP is protected accordingly.

## The Electronic Nose

This proof-of-concept functions like a human nose: Odors are taught first to ensure the detection of volatile organic compounds (VOCs) that emit odors or may be harmful to health. These are usually hydrocarbon compounds. The system selectively stimulates the compounds and analyses and characterizes their behavior physically and biochemically, thereby detecting the biomarkers of the previously taught substances.

## The Odor Eliminator (UVA)

The Odor Eliminator makes use of the odor-destroying properties of UVA LEDs. The state of volatile compounds and volatile organic compounds (VOCs), which emit unpleasant odors and can be harmful in excessive concentrations, is dynamic. The Odor Eliminator selectively stimulates the volatile substances in a controlled manner, changes their molecular composition, and destroys them with the help of UVA LEDs. An additional photocatalytic process prevents the production of ozone in the ambient air.



## The Virus Eliminator (UVC)

The Virus Eliminator utilizes the disinfecting effect of UVC LEDs. The safe and enclosed system precisely changes and destroys the molecular and organic composition of viruses and bacteria in the air.

## The Wasp Scare

The Wasp Scare selectively influences the sense of smell of wasps and mosquitoes within a defined radius. Their sense of smell is thus limited, meaning the insects are unable to sense stimuli, for example the smell of fruit or meat, in this radius. The technical solution can be adapted to a variety of insects.

**Under development:**  
Development Kit RDK3

Curse and blessing of MLCC version diversity

# Interesting facts for more supply security

*The wide range of ceramic capacitors is both a curse and a blessing. In times of shortage, there are more alternatives. This can, however, complicate the release processes, increase the logistical effort, and thus slow things down in general. Nevertheless, there are many ways to use the diversity of capacitors to establish supply security.*

BY JÜRGEN GEIER, TECHNICAL EXPERT  
CERAMIC CAPACITORS AT RUTRONIK

**W**ith new materials and mixtures as well as different designs in terms of arrangement and structure, suppliers of ceramic capacitors have created numerous optimized components in recent years. As a result, there is an array of specific capacitors to choose from for varying applications and functions with special requirements. These differ with regard to their properties, size, or design, thereby meeting a wide range of requirements. The best-known variants include, for example, the high-frequency (HF), high-quality (HiQ), radio-frequency (RF), microwave, low-inductance, and low-loss types, capacitors with internal copper electrodes or end terminations for conductive bonding, and so-called X2Y versions.

### *Special types for specific applications*

In addition to the aforesaid types, other special capacitor variants are also available, such as variable capacitors, which offer voltage-controllable and thus variable capacitance by utilizing the DC bias response (Fig. 1).

TDK's CeraLink capacitors are specially designed for high currents, as they exhibit an increase in capacitance over the applied voltage across wide areas (Fig. 2).

Also less known are the 3D silicon capacitors. They use the third dimension to substantially increase the capacitor surface and thus its capacitance. Murata, for instance, offers a 0402 size model, measuring just 100 µm in

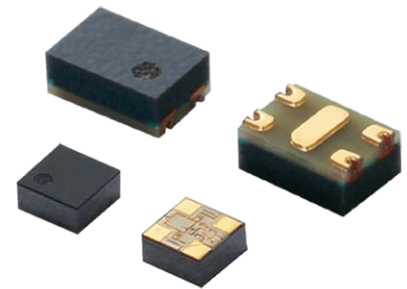

Image Murata

Figure 1: Variable capacitors use DC bias response to create a variable capacitance.

height, which delivers 100 nF. The 3D capacitors respond similarly to NPO types, and are particularly suitable for HF applications up to 110 GHz and high-temperature applications up to 250°C (Fig. 3).

### *When supply security matters*

All these special types have the following in common: They are particularly optimized for specific requirements or applications but are thus also frequently referred to as single-source components. This means that there is no alternative, which often leads to significant procurement difficulties when supplies are short and allocation periods long.

This problem arises not as much with basically standard MLCCs. Here, too, different variants are available, e.g. with varying C-value tolerances, voltages, or temperature ranges, with special terminations (soft termination, silver-palladium), or as commercial or automotive grade components. However, many models match in design, size, ceramic



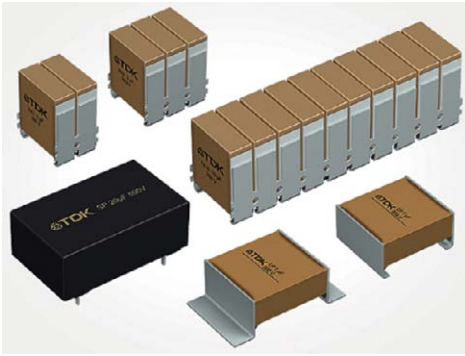

Figure 2: TDK's compact CeraLink capacitors can be used both as snubber and as DC link capacitors.

type, etc., so there are usually several alternatives to choose from for these capacitors (so-called CV products).

### Smart parameter setting for alternatives

Progressing digitization makes it easier to handle multiple variants, but at the same time it also ensures that the selection is only made exactly according to the defined parameters. It is often the case, for example, that a capacitor with a tolerance of 20% (code letter

M) has been defined, but when searching for alternatives, components with the better tolerance value of 10% are not accepted because the designation fails to match.

Rutronik has created the table as an orientation aid to facilitate the search for alternatives. It indicates in which directions an exchange is uncritical and when this exchange is in fact possible, but individual parameters must be checked first.

In order to obtain a cost-effective and flexible result for redesigns and new developments, it

is also advisable to focus on the smallest possible design and to define the parameters, e.g. voltage, tolerance, but also the type of ceramic (which also defines the temperature range), on the basis of the actual requirements. This avoids oversizing, which also limits the choice of alternatives. However, when searching for alternatives, the components with better specifications must then also be approved. If these tips are followed, users will benefit from the diversity of variants, especially in times of short supply. ■

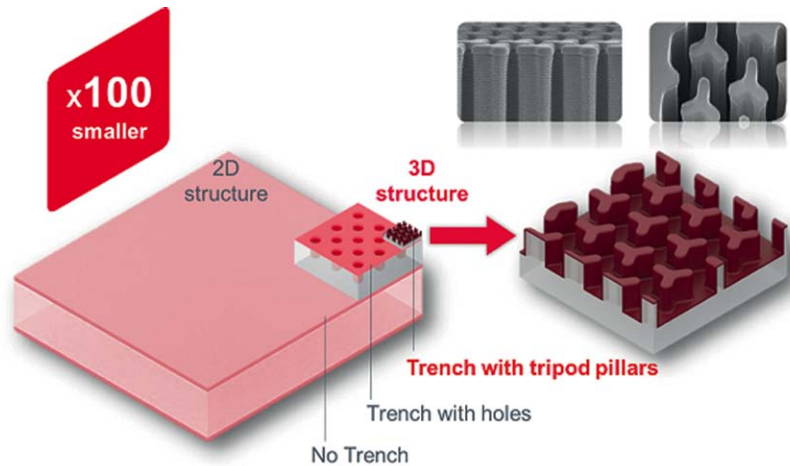
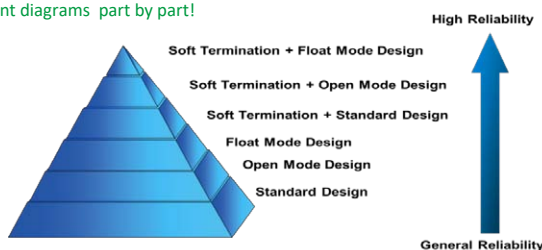

Figure 3: The 3D structure enables miniaturization by a factor of 100.

Parameter	Acceptance	to "worse"	Origin	to "better"	Acceptance	Comments
Ceramic						will be o.k. against lower temp.
Ceramic	to check	X5R	X6S	X6R/X7R	yes	attention to specified temperature and drift
Ceramic	to check	X5#/X6#	X7R	X8R	yes	attention to specified temperature and drift
Ceramic	to check	X7R	X8R			attention to specified temperature and drift
Ceramic	...	...	...	...	...	...
Tolerance						principally a smaller tolerance is acceptable against a greater one
Tolerance	to check	$\geq 0,25\text{pF}$	0,10pF	$\leq 0,05\text{pF}$	yes	for values $\leq 10\text{pF}$
Tolerance	to check	$\geq 5\%$	2%	1%	yes	generally recommendation: avoid this small tol.
Tolerance	to check	20%	10%	$\leq 5\%$	yes	is standard-tol. for X#R
Tolerance	...	...	...	...	...	...
Voltage						principally a higher voltage will be o.k. against a lower
Voltage	to check	$\leq 10\text{V}$	16V	$\geq 25\text{V}$	yes	lower voltage should be checked by real request, could help for additional alternatives
Voltage	to check	$\leq 16\text{V}$	25V	$\geq 50\text{V}$	yes	or/and smaller size
Features			commercial	AECQ200	yes	
Features	to check	commercial	AECQ200	AECQ200 plus	yes	
Features	to check	standard	OpenMode	Softt./OM/FL	yes	See reliability-pyramide
Features	to check	standard	OpenMode	Softtermination	yes	
Features	...	...	...	...	...	

Generally should be checked what's real request, because often used fixed combinations by supplier  
i.e. all Samsung X7R Automotive-parts automatically with Softtermination, and some additional with OpenMode

A further point should be checked generally too, it's the allowable C-drop in the circuit by the DC-Bias!  
It's to check by the relevant diagrams part by part!



This table is just an excerpt of the complete table which can be found at [www.rutronik.com/de/mlcc](http://www.rutronik.com/de/mlcc).

Overview of possible alternatives and critical parameters.

Tantalum polymer capacitors

# Effective decoupling

*Decoupling capacitors do more than just prevent voltage drops and pulse peaks on the supply lines from reaching the circuit in the application and limiting its functionality. When the correct capacitors are selected, they can also reduce costs, required space, and idle state power consumption.*

BY TOBIAS BAISCH, CORPORATE PRODUCT MANAGER CAPACITORS AT RUTRONIK, AND PRANJAL SRIVASTAVA, F&E CENTRAL EUROPE AT YAGEO GROUP

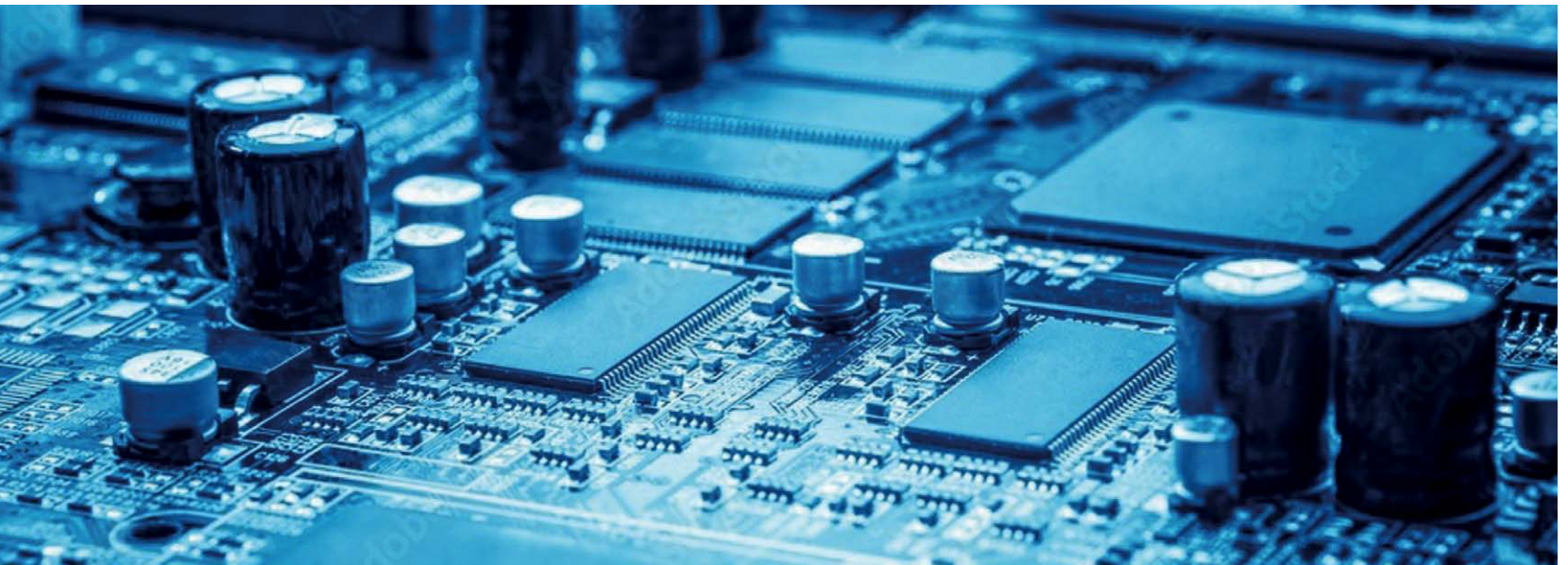

Image: Pavel Timofeev/stockadobe.com

There are several reasons that speak in favor of using decoupling capacitors: They are connected to the supply pin on the IC, where they eliminate high-frequency noise before it negatively impacts or influences functionality of the ICs. Further, they smooth out any high-frequency voltage peaks caused by switching regulators. Voltage and current ripple of DC/DC converters are somewhat of a general problem, especially in applications like sensor measurement technology.

Furthermore, the decoupling capacitor acts as a local power storage system. It supplies the IC with the required amount of power during short power outage or decoupling windows (typically in the  $\mu\text{s}$  range) or during the switching intervals of a switched-mode power supply.

Roughly 30 to 80%, sometimes even more, of a bill of materials is made up of decoupling capacitors. The exact amount depends on the type and requirements of the active ICs used on the printed circuit board, the shape and size of the input power, and the EMC requirements on noise immunity and emissions. Selection of the correct decoupling capacitors can therefore help to significantly reduce costs, required space, and idle state power consumption. So, it is crucial to consider things carefully when choosing decoupling capacitors.

## *Advantages and disadvantages of typical decoupling capacitors*

The designs considered below are mainly intended for analog, digital, or mixed-signal

systems supplied with voltages of 50 V or less. This voltage level is usually converted down to 1 V, 1.3 V, 1.8 V, 3.3 V, 5 V, 10 V, or 12 V.

Decoupling with capacitances up to 10  $\mu\text{F}$ : For voltages up to 50 V and capacitances up to 330 nF, COG-based multilayer ceramic capacitors (MLCCs) are the best currently available technology in terms of space required, cost efficiency, and leakage current characteristics.

X7R/X5R-based MLCCs are the capacitors of choice for capacitances up to 10  $\mu\text{F}$ . In this case, however, the DC bias behavior must be taken into account to ensure the required capacitance at the actual application voltage.

Tantalum or aluminum polymer capacitors can be used in the 5  $\mu\text{F}$  to 10  $\mu\text{F}$  range. However, they usually have higher leakage currents and

# Driving the Future with Silicon Carbide Technology

The next generation material to realize longer cruising range  
and faster charging time



To drive an electric vehicle (EV), the power train plays a key role. The heart of the power train is the power electronic system (inverter). IGBT as main power switch is still dominating the market of power train inverter. Requirements like space, weight and efficiency play an increasing role. Product development and manufacturing expenses should remain low while the design effort should result in more compact systems and, at the same time, product quality and reliability should be guaranteed. This leads to more demanding design requirements on the system and component level and ultimately affects the overall consistence of power devices and other system components. It is well known today that Si based IGBTs almost reached their physical limits. This fact opens the door for new semiconductor material such as Silicon carbide, which gain in the last few years acceptance from the automotive community as reliable and efficient power device for power train application.

The current trend from the major automotive power train suppliers is centric around 800-volt SiC inverter solution while some attention on 400-volt SiC inverter solution remains. Higher voltages (400V or 800V) and higher charging power (up to 350kW) can extend the cruising range and shorten the charging time through quick charging, which will greatly enhance the convenience of people's lives.

In this context SiC semiconductors – e.g. SiC MOSFETs for 800-volt and 400 battery systems – offer more efficient switching in the inverter (higher frequency, steeper switching slopes). ROHM has recently announced the release of 4th generation SiC MOSFETs, which has evolved from the existing trench gate structure. The latest generation has achieved a 40% reduction in on-resistance and a 50% reduction in switching loss compared to the previous generation.

It's safe to say that SiC power semiconductors are key power devices for increasing the convenience and power conversion efficiency in applications where high voltage and high current density are progressing such as EVs.

With an in-house vertically integrated manufacturing system, ROHM provides high quality products and stable supply to the market. Take the next development step with our Generation 4 SiC power device solutions.

For more ROHM SiC power devices information, visit:  
[www.rohm.com/products/sic-power-devices](http://www.rohm.com/products/sic-power-devices)

are more expensive and larger – the smallest one from Kemet is an 0805 (2,012 in mm).

For example, buffer capacitance in the 8 µF to 10 µF range at 5 V can be achieved using an X7R-based MLCC with 10 µF (8.2 µF at 5 V DC bias), 10 V, 1206, e.g. C1206C106K8RAC-TU from Kemet, or a tantalum polymer capacitor with 15 µF, 6.3 V (with voltage derating), 3528 (comparable design ~1210 MLCC), e.g. T520T156M006ATE100 from Kemet.

X7R, however, offers advantages due to its smaller dimensions, lower price, lesser leakage current, and higher ripple current strength – a factor of almost six at 100 kHz.

Decoupling with capacitances above 10 µF: When it comes to decoupling large capacitances (> 10 µF, DC voltage < 50 V), either X7R/X5R MLCC banks, electrolytic capacitor/capacitor banks, or polyester or polypropylene-based film capacitors are traditionally used. But there are a few things that need to be borne in mind.

X7R/X5R MLCC banks with high nominal voltages are used to compensate for the DC bias effect. This involves connecting a number of capacitors in parallel, which is both expensive and space-consuming. The amount of space required increases additionally with the necessary decoupling capacity. Further, the leakage current increases, and its practical determination for the overall design becomes decidedly more complex.

Additional compensation is required to meet the high-capacitance requirements at high temperatures. As such, a combination of varying capacitor technologies connected in parallel is usually recommended, on the one hand, for filtering higher frequencies and, on the other hand, for filtering low interference, such as 50/60 Hz hum or vibrations in the single-digit Hz range. At the same time, there is a high risk of cracking if X7R capacitors

are exposed to excessive mechanical vibrations.

Electrolytic capacitors or electrolytic capacitor banks generally have a higher ripple current strength. That said, they are often oversized to accommodate for this gain. This is necessary to compensate for or reduce higher equivalent series resistance (ESR).

Since ESR increases over a capacitor's service life, the capacitor is additionally oversized to avoid any problems in this respect. It obviously also leads to an increase in the amount of space required and costs.

Compared to MLCCs, electrolytic capacitors have a high leakage current. The capacitance drop with frequency may cause problems in effectively filtering a wide range of frequencies. To cover all frequencies, it is often necessary to have another MLCC connected in parallel. THT (through hole technology) electrolytic capacitors are commonly applied, which in turn leads to challenges associated with equipping.

Polyester or polypropylene-based film capacitors are not susceptible to cracking or high leakage currents and offer a higher ripple current capability. Film capacitors that achieve the same capacitance/nominal voltage as MLCCs or electrolytic capacitors are comparatively large and expensive.

*Reducing costs and space required with tantalum polymer capacitors*

Tantalum polymer capacitors combine many advantages that the aforesaid technologies are unable to fully achieve. It starts with the material used: Unlike conventional tantalum capacitors, MnO<sub>2</sub> is replaced by an electrically conductive polymer. In the event of reverse polarity or a short circuit, there is, therefore, no risk of fire.

Further, in contrast to MLCCs, they also have no DC bias effect. As such, a capacitor bank is not required to compensate for voltage-dependent losses in capacitance. The capacitance of tantalum polymer capacitors is additionally not temperature-dependent, and there is no risk of cracking or hum noises with these capacitors.

Yet another advantage is their higher ripple current capability compared to electrolytic capacitors. Moreover, their capacitance drop is not as significant at high frequencies, resulting in better high-frequency capability. The leakage current is also lower in some cases than with electrolytic capacitors.

Further, tantalum polymer capacitors are not subject to aging effects and the ESR remains constant throughout their service life. A high capacitance-to-volume ratio enables compact SMD designs from 0805 to 7343.

The table shows the various types of capacitors with the parameters needed to meet the requirements of a brushless DC motor (BLDC) module with a minimum of 30 µF at 16 V, a total ripple current of approximately 10 A at 10 kHz, a leakage current below 100 µA, and a temperature of up to 105°C.

It can be seen from the table that the use of tantalum polymer capacitors can free up a lot of space and costs compared to MLCC or electrolytic capacitors. Added to this are a longer service life, a better high-frequency response, and a compact SMD package.

*Aluminum or tantalum polymer capacitors*

Alongside tantalum polymer capacitors, aluminum polymer capacitors are also becoming increasingly popular. At an operating voltage below 10 V and a temperature of less than 105°C, the response of the two polymer capacitors is very similar. However, if these values are exceeded, tantalum polymer capacitors operate more reliably.

Despite offering a range of advantages, there are also certain disadvantages. At present, they are only available with a nominal voltage of up to 100 V. A voltage derated by at least 10% is recommended for temperatures up to 105°C, and even higher for greater temperatures (Figure).

Since it is a polarized capacitor, a reverse polarity protection diode should be used to pro-

X7R-based capacitor bank	Electrolyte-based capacitor bank	Polymer-based capacitor bank
2.2 µF 50 V 2225 1.882 A	390 µF 25 V 10 mm x 12.5 mm 2.2 A	15 µF 35 V 7343 4.16 A
15 capacitors connected in parallel required to reach the minimum capacitance	5 capacitors connected in parallel required to meet the minimum ripple current requirements	3 capacitors connected in parallel required to meet the minimum ripple current and capacitance requirements
Total area: 716.8 mm <sup>2</sup> Lowest leakage current	Total area: 1571 mm <sup>2</sup> Low leakage current	Total area: 94.17 mm <sup>2</sup> Low leakage current

Comparison between commonly used decoupling capacitor technologies with the BLDC module as an application example.

tect against reverse polarities. The leakage current is higher compared to an MLCC or a conventional tantalum capacitor. Further, special attention has to be paid to the specified humidity at high temperatures to avoid any problems caused by excessive THB (temperature humidity bias) conditions.

*Decoupling large capacitances  
in safety-critical applications*

Tantalum polymer capacitors are used whenever large capacitance decoupling is required for all types of control boards and embedded electronics. Their compact, low-profile SMD design makes them an ideal link between small-capacitance MLCCs and large-capacitance electrolytic and film capacitors, which are usually used as DC link capacitors for high voltages and large power requirements.

A great many tantalum polymer capacitors are validated and approved for use on both sides of a DC/DC converter within a vehicle. This has led to their widespread adoption among ma-

for car manufacturers. In small drive systems, they can also be applied as DC link capacitors, as shown in the BLDC example above.

Kemet and Rutronik help customers find a space- and cost-optimized solution for their PCBs with high-quality and reliable polymer capacitors. ■

Image: Kemet

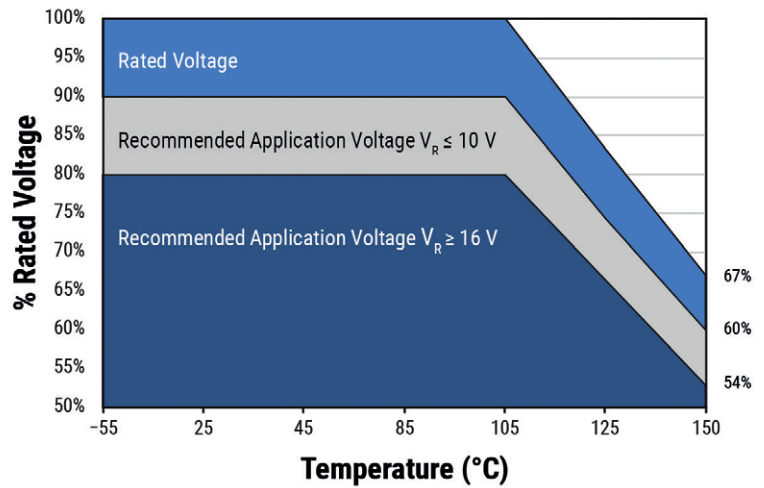

Voltage derating of tantalum polymer capacitors depending on the temperature.

Advertisement

# Introducing nRF7002 Nordic's first Wi-Fi IC



LEARN MORE ABOUT  
OUR WI-FI SOLUTION  
[nordicsemi.com/nRF7002](http://nordicsemi.com/nRF7002)



Vibration-resistant electrolytic capacitors

# Solid as a rock

*Vibrations are not usually associated with electronic assemblies. However, it is not at all uncommon for these assemblies to be subjected to strong mechanical vibrations. And with electrolytic capacitors, this can lead to sudden failure. Some capacitor suppliers, though, have managed to come up with solutions to this problem.*

BY SVEN MIGUEL RODRIGUEZ,  
CORPORATE PRODUCT MANAGER  
CAPACITORS, AND  
CHRISTIAN KASPER, TECHNICAL  
EXPERT CAPACITORS, BOTH AT RUTRONIK

Vibrations do not only occur in applications with vibrating parts such as internal combustion engines. Electronic components are also exposed to vibrations in industrial punching machines, fast-moving linear actuators, pumps, and gearboxes. All of them generate a vibration profile that can cause an electrolytic capacitor to fail.

A common failure is broken capacitor connections. The breaking point is either directly at the solder joint to the board or inside the capacitor at the connection from the terminals to the anode and cathode foil.

Usually, a capacitor fails completely unexpectedly without significant measurable

changes to its electrical properties. The reason for this is that there is little indication of whether the component is exposed to excessive vibrations and, therefore, prone to failure. At best, an increased residual current may be detected if the mechanical stress has damaged the oxidation layer between the winding and the case. If sufficient electrolyte is available, this damage is repaired by the self-healing effect. If, on the other hand, microcracks occur in the capacitor connections, a measurably increased ESR value can usually only be detected shortly before breakage.

Another failure is caused by rubbing of the winding inside the case wall, which also leads to capacitor failure in the long run.

*Reliable, vibration-resistant capacitors according to requirements*

In order to offer reliable components that can withstand loads of up to 30 G, some capacitor suppliers have developed series featuring a vibration-resistant design. But when is a component considered vibration-resistant?

A common, standardized vibration test profile used by suppliers for testing may look like the one in the table below.

It indicates in which frequency range and with which amplitude the capacitor withstands up to which acceleration. However, since every application has different vibration frequencies, resulting in very different profiles, suppliers also offer individual tests and approvals based on specific customer requirements. This ensures that the approved component meets the respective requirements.

If the capacitor supplier is involved in the development process, they can design the com-



image: omixAS/stock.adobe.com

**Single Board Computer**  
incl. cooling solution + cables  
24V Power Adapter (opt.)

**sample price €99,--**  
via Rutronik



**4x Cortex-A53**  
**@1.8GHz + -M7**

**NPU for**  
**KI tasks**

**2x Gbit LAN,**  
**Wifi 5, BT 5.0**

**Camera, Audio,**  
**4x USB (3.0), 2x CAN-FD**

**LVDS, DVI, MIPI-DSI**

**Tested Linux**  
**Yocto BSP**

**Windows 10 IoT**  
**Enterprise**

**Secure Boot and**  
**OTA Update**



Acceleration	294 m/s <sup>2</sup> (30 G)
Frequency	5 Hz ~ 2,000 Hz
Amplitude	5 mm
Direction and duration of the vibration	toward the X, Y, Z axis for 2 hours each, for a total of 6 hours

Typical profile for a vibration test

ponents precisely to ensure they can be used at their load limit. This prevents over-specification and allows a better design-to-cost ratio.

The electrolytic capacitor market offers, depending on the mounting method, various designs and approaches to increase vibration resistance.

*Designs and approaches  
for the ideal result*

Axially mounted THT capacitors tolerate vibrations better than radial THT or SMD modules. Since horizontal mounting means that their center of mass is significantly lower due to the reduced height, this results in less leverage forces acting on the connecting pins.

However, vertical mounting is much more common. In this case, the center of mass sits higher, which makes a vibration-resistant design more demanding. One approach is to reduce the free space in the capacitor case. To do so, the winding is wound tighter and the inner diameter of the case reduced. This leaves less room for the winding to move and reduces rubbing effects. Another option is to taper the case at points from the outside so that the winding is fixed inside.

In both cases, the wire diameter of the connecting pins must be reinforced to ensure they can withstand the occurring forces without being damaged. Greater stability is provided by additional retaining pins without electrical function, as is the case with snap-in pins. They generally make sense for large and/or heavy components.

If the capacitor is subject to extremely strong vibrations, it is advisable to additionally fix it to the circuit board with an external holder, which is usually made of plastic. Alternatively, the components can also be potted or fixed with adhesive. In this case, however, it should be clarified in advance with suppliers whether the ingredients of the adhesive or compound could have a negative impact. With potting, heat can no longer be dissipated that

well due to poorer thermal conductivity, which leads to a shorter service life. In both cases, bonding and potting, material incompatibility of the adhesive and the compound could also occur in the component. Therefore, the utmost care must be taken when selecting the materials to be used. It is recommendable to consult Rutronik's product specialists and material experts to avoid unpleasant surprises.

For SMD capacitors, the approach is similar to that for THT components. This restricts the movement of the winding in the case. However, to prevent the connections from breaking off, the SMD components offer yet another option: They are equipped with a base plate with additional plastic bars attached to the sides. This fixes the capacitor case in place. Vibration-resistant models also have enlarged solder pads to mechanically strengthen the solder joint. Other external supports are not used. However, bonding and potting as with THT modules are also possible with SMD designs.

*Supported by the board layout*

In addition to selecting vibration-resistant components, it is also important to pay attention to vibration safety in the circuit board layout. This prevents the creation of areas with strong vibrations. The force acting on the capacitor can be minimized by shifting the resonance points. But this does not solve the vibration problem. Therefore, vibration-resistant capacitors are of key importance. Suppliers are constantly working on their further development, and we can expect to see new series in the future that are able to withstand even higher forces. ■

THB grades for film capacitors

# Robust and durable

*Capacitors are facing ever-tougher requirements. With film capacitors, the main concern is protection against the ingress of humidity, as this protection increases reliability and service life considerably.*

BY MARCEL FRITZ, CORPORATE PRODUCT MANAGER CAPACITORS, AND CHRISTIAN KASPER, TECHNICAL EXPERT CAPACITORS, BOTH AT RUTRONIK

Even during production, there is a risk of humidity becoming trapped in the capacitor. High humidity during operation can attack the vaporized metallized layer on the film capacitors. If the tightness of the plastic case or compound is insufficient, humidity may penetrate the capacitor.

In the case of RFI (radio frequency interference) capacitors, humidity also causes, in addition to corrosion of the metallized layer, what is known as the corona effect when voltage is applied. The resulting ionization process damages the metallized layer of the film. The consequences are loss of capacitance and a faster rise in the loss factor.

With DC capacitors, humidity in the component also leads to corrosion of the metallized layer, which has a particularly negative impact on its reliability and service life. Therefore, it is imperative to prevent the ingress of humidity so as not to compromise the performance of the components.

Besides empirical studies, numerous analyses also show that the ingress of unwanted humidity into film capacitors is the number one cause of a shortened service life.

## What is THB?

A recognized standard for accelerated service life testing is the temperature-humidity-bias (THB) test. This reliability test is aimed at accelerating the aging process of capacitors and measuring whether the capacitors maintain their capacitance, loss factor, and isolation resistance at a given temperature, relative humidity (RH), and nominal voltage over a defined period of time (Table 1).

Capacity	$ \Delta C  \leq 10\%$
Loss factor	0.024 for $C \leq 1 \mu\text{F}$ 0.015 for $C > 1 \mu\text{F}$
Isolation resistance	> 50% of applicable limit values

Table 1: Requirements (acceptance criteria) regarding THB to IEC 60384-14 AMD1:2016 (source: Kemet)

Depending on the testing level (Table 2), the capacitors meet various climatic requirements. For example, in a Grade IIIB high robustness under high humidity test, the capacitors must withstand 85°C and 85% relative humidity for 1,000 hours of operation undamaged with an applied nominal voltage.

With capacitors that survive these tests, the most important electrical parameters remain significantly more stable over the entire service life than with a standard component. As a result, THB components offer a longer service life and greater reliability.

As shown in Table 2, THB Grade IIB and IIIB are among the toughest test conditions and differ only in terms of how long the voltage is applied.



Image: Vishay

The F340 series from Vishay with THB Grade IIIB RFI capacitors.



Grade (I) – Robustness under Humidity	Test A: 40°C, 93% RH, 21 days rated voltage
	Test B: 85°C, 85% RH, 168 hours rated voltage
Grade (II) – Robustness under High Humidity	Test A: 40°C, 93% RH, 56 days rated voltage
	Test B: 85°C, 85% RH, 500 hours rated voltage
Grade (III) – High Robustness under High Humidity	Test A: 60°C, 93% RH, 56 days rated voltage
	Test B: 85°C, 85% RH, 1000 hours rated voltage

Table 2: THB levels to IEC 60384-14 AMD1:2016 (source: Vishay)

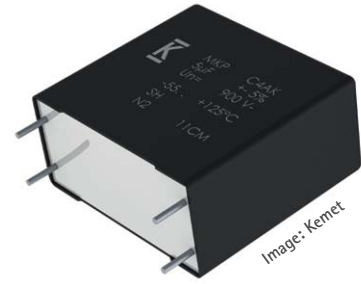

The DC-Link C4AK series from Kemet meets THB Grade IIIB and offers high voltage and long service life even at 125°C.

### Where does the trend toward THB components come from?

Demand for THB components is increasing. One reason for this is the IEC standard for RFI capacitors that has been in force since 2016. It stipulates that capacitors must meet at least THB Grade I.

A strong driver of the trend toward THB components is the automotive segment, but THB components are also increasingly being used in industry. The reasons for this are obvious when considering the climatic conditions under which solar inverters, for example, must operate as long and as reliably as possible.

Since a supplier of inverters, for example, usually has no prior knowledge of where its products are going to be used, it makes sense to design the inverter – and thus also the capacitors – for the worst-case conditions. This means they perform reliably even under the toughest operating conditions.

### How do THB components differ from standard components?

The suppliers achieve an increased service life and reliability of THB capacitors through a special design. Five factors are crucial in this respect:

- Package: PPT package or PPS package with increased tightness
- Compound: High-degree epoxy resin with high resistance to humidity
- Plastic film: Thicker, i.e. multiple-layered, film for better self-healing
- Metallized layer: Mixture of different metals for better self-healing
- Production: Ensuring low humidity in production

Some suppliers also rely on internal series arrangement of the films to further reduce the ionization voltage on the film.

### Where are THB capacitors used?

THB capacitors are predestined for applications exposed to high temperatures – or more importantly, large temperature fluctuations – and/or high humidity. Their use is particularly recommended in these conditions. Mainly due to the high temperature loads, this includes practically all automotive applications for the actual vehicle, but also applications for the vehicle infrastructure, e.g. charging stations or wall boxes. In the industrial sector, this mainly encompasses inverters, solar inverters, frequency converters, smart meters, and wind turbines. In addition, THB models are ideal for all applications that place high requirements on the service life and reliability of a film capacitor.

### Summary

The comparatively new type of film capacitor is characterized by increased reliability and longer service life. Thanks to these improved properties, new and sustainable uses are possible in trendsetting applications, e.g. in the field of electromobility or renewable energies.

Advertisement

Quartz crystals, oscillators, and real-time clocks

# Delivery capability thanks to own quartz crystal production

*The supply chain disruptions that have occurred in many markets have also had an impact on quartz crystals, oscillators, and real-time clocks. Suppliers with their own quartz crystal and IC production obviously have a clear advantage. They are not only able to offer products with reliable quality but also significantly shorter delivery times.*

BY JOCHEN NELLER, TECHNICAL EXPERT  
INDUCTORS AT RUTRONIK

**K**Hz quartz crystals, also known as clock quartz or tuning fork crystals, are suitable, e.g., for the discrete design of an oscillator with a controller or RTC IC (real-time clock). The key parameters of such a design are the negative resistance (oscillator gain) and the load capacitance of the overall circuitry necessary to satisfy the phase and amplitude condition ( $k \cdot v > 1$ ) of a self-oscillating oscillator.

The supply situation for kHz quartz crystals has been plagued by shortages over the last two years. Suppliers who produce quartz crystals themselves are generally still able to deliver, while many others who buy in the raw material have had to increase their delivery periods from around 16 weeks to up to two years. The fact that many well-known suppliers have removed kHz quartz crystals from their portfolios over the years further complicates the situation.

*In-house production increases reliability in terms of quality and delivery time*

One supplier that produces its quartz crystals completely in-house is Epson. They are produced in the company's own autoclaves from self-grown synthetic quartz crystals. Epson is, therefore, not only able to ensure availability but also reliable, consistent quality.

In the meantime, Epson focuses entirely on the SMD design for kHz quartz crystals, available in particularly small designs with welded metal covers (FC3215AN, FC2012AN, and FC1610AN series). Plastic encapsulated cylinder housings are also still part of the portfolio. However, they are no longer recommended for

new projects, as the trend in production planning and capacity expansion continues to move toward smaller designs.

For the FC2012AN and FC3215AN series, Epson has been able to lower the maximum equivalent series resistance (ESR) to an attractive level of 50 k $\Omega$ , which counters the usual increase in ESR with smaller sizes. For these and the FC-12M and FC1610AN series, delivery times have now been reduced to 18 weeks (as of September 2022).

## *MHz quartz crystals*

The insatiable appetite for ever greater volumes of data and thus higher transmission speeds inevitably leads to increased demand for higher frequencies. MHz quartz crystals are also available in increasingly smaller packages (FA-128, FA-118T, and FA1210AN series) as development of this technology also follows the goals of increasing efficiency and minimizing costs.

QMEMS, a wafer-based process, combines the high stability and precision of quartz crystals with MEMS technology to achieve high performance in compact packages. In the photolithographic process, the thickness shear mode oscillators (AT cut) become washed, cut chips with a fine structure. These chip shapes have a larger electrode area and thus lower electrical resistance values and come in small designs. Special further processing using high fundamental frequency (HFF) technology gives them high mechanical stability even with low crystal thickness. The result is fundamental wave oscillators with frequencies of up to 500 MHz.

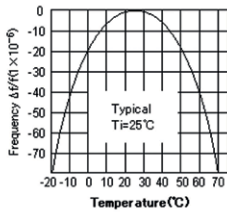

$$\Delta f/f = B(T_i - \theta X)^2$$

$\theta X$ : specified temperature, B: Parabolic coefficient

Figure 1: Flexural vibrations and temperature behavior of a typical kHz quartz crystal.

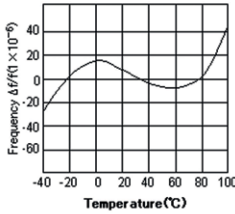
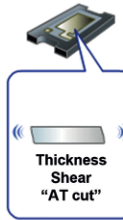

$$\Delta f/f = \alpha (\theta X - 25)^3 + \beta (\theta X - 25)^2 + \gamma (\theta X - 25)$$

$\theta X$ : specified temperature

Figure 2: MHz quartz crystal with AT cut and typical temperature-based vibration behavior.

Often, the current market delivery times for MHz quartz crystals are two years or more. However, for some series (e.g. FA-128, FC-12M, and FA-20H) and technical parameters, Epson is able to deliver the products after approx. 18 weeks (as of September 2022).

### SPXOs – programmable oscillators

SPXOs (simple packaged crystal oscillators) are the simplest crystal oscillators without compensation or temperature control. They consist of a quartz crystal unit and an oscillating circuit.

For models that exhibit very low jitter (phase noise) even at high frequencies, Epson uses only quartz crystals as the fundamental wave

oscillator in addition to specially developed low-noise oscillator ICs, either using HFF quartz crystals or with a PLL (phase-locked loop; Fig. 3).

With this self-developed oscillator IC compensating for the frequency or temperature coefficient of the HFF quartz crystal, the new SG2520 series achieves low phase noise and improved frequency stability of 25 ppm (SG2520\_EGN/VGN) and 20 ppm (SG2520\_EHN/VHN) at -40 to +125°C.

PLL technology ensures programmable frequencies of between 0.67 MHz and 170 MHz. This allows the modules to be set to a specific frequency (with six decimal places) as required, which significantly improves availability. The SG-8018 series also has a low deviation of 50 ppm at -40 to +105°C, including aging stability over ten years. Even more accurate is the SG-8101 series with a tolerance of 15 ppm, thanks to integrated temperature compensation. Due to its programmable spread spectrum capability, the SG-9101 series is particularly well-suited for reducing EMI problems. It is available with operating voltages ranging from 1.62 to 3.63 V in various package sizes.

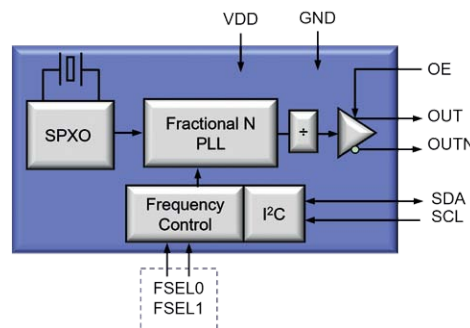

Figure 3: Programmable oscillators can generate any desired frequency using a phase-locked loop.

In recent years, the demand for SPXOs has risen sharply. Suppliers like Epson with their own development and production operations obviously have a competitive advantage. Due to the high level of demand, it is recommendable to plan projects in good time.

### TCXOs – temperature-compensated crystal oscillators

Temperature-compensated crystal oscillators (TCXOs) are available for sensitive applications that require stable frequencies even with large temperature fluctuations or over a wide temperature range (Fig. 4). By providing its own ICs, Epson can also produce the ASICs for its TCXOs and optimally match the individual components, such as the control voltage generator, correction circuitry, and oscillator core. In addition to TCXOs with CMOS outputs, Epson's portfolio primarily includes those with clipped sine wave outputs. As the name suggests, their sinusoidal signal is clipped and thus generates significantly fewer harmonics in relation to CMOS, resulting in better EMI behavior. Offering the highest stability and low phase noise, the TG2016SxN and TG-2025SxN series are ideal for use in wireless communication devices.

SPXOs and TCXOs have been particularly affected by supply chain disruptions. And the massive fire that destroyed the semiconductor factory of Asahi Kasei Microdevices (AKM) in 2020 is still aggravating this situation. The Japanese IC manufacturer had a market share of between 80 and 90% in temperature-compensated crystal oscillators (TCXOs). The result of the fire was a global shortage of all oscillator types. Since Epson has equipped almost all TCXO lines with ICs developed and produced in-house for several years, the supplier

## Industrial embedded storage solutions since 1988

SSD | DRAM | SD Card | μSD Card | CFAST | USB | eMMC



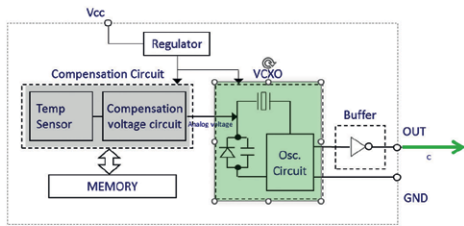

measure temperature, adjust frequency

**TCXO output: Green curve**

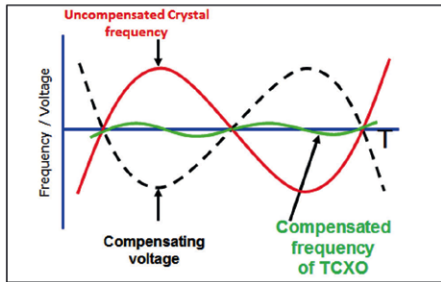

Figure 4: TCXOs achieve a temperature-stable frequency thanks to a compensating voltage.

has been able to meet many targets. In the meantime, Epson has almost doubled its production capacity, so that delivery times of approx. 18 weeks (as of September 2022) or faster are now the norm.

*RTCs – real-time clocks*

A discrete design with oscillators enables customized solutions but also requires an understanding of the individual components. Hence, errors often occur that result in a lot of time being spent on design corrections. It is actually much easier to use ready-made real-time clocks (RTCs).

Epson offers complete modules including quartz crystals, semiconductors, oscillators, and other components for many additional features (wakeup timer, alarm, timestamp, battery charging function, flexible pin assignment FOUT/timestamp) in a package with I<sup>2</sup>C protocol, but also with 3- or 4-wire SPI. This not only reduces development time, but usually also space requirements and power consumption.

Highly accurate RTCs also include a DTCXO (digital temperature-compensated crystal oscillator). The deviation of the output frequency is compensated with the help of this digital circuitry. For example, RX8900CE and

RX8804CE achieve a maximum deviation of 9 s/month at -40 to +85°C and 21 s/month at -40 to +105°C, respectively.

The latest RX8901CE series achieves a standby current of typically just 240 nA despite temperature compensation up to 105°C and also includes a maximum number of additional functions for the most versatile applications.

As demand for RTCs continues to grow to meet the increased temperature requirements, standby times, and functionality of many applications, it is recommended to plan and phase projects carefully. This helps to avoid delivery times of six to twelve months (as of September 2022).

**Publishing details**

Editorial staff:

Andreas Mangler – Rutronik, Director Strategic Marketing and member of the extended management board (Editor-in-Chief, responsible for all content), phone +49 7231 801 0  
 Markus Krieg – Rutronik, Chief Marketing Officer  
 Christine Schulze – Christine Schulze PR | Kommunikation  
 Andreas Brenner – Rutronik, PR Manager  
 Dr. Alena Kirchenbauer – Rutronik, Team Leader International Communication

Advertising Manager: Ipek Baskurt – Rutronik, Communication Designer  
 Final editing: Achim Grolman, Markt&Technik  
 Layout and Design: Wolfgang Bachmaier, Markt&Technik; Pierre Ittner, Markt&Technik

Print: L.N. Schaffrath Druck Medien, Marktweg 42–50, 47608 Geldern

Publisher and general address: Rutronik Elektronische Bauelemente GmbH, Industriestr. 2, 75228 Ispringen, Germany, phone +49 7231 801 0, fax +49 7231 82282

Copyright: All articles published in Rutroniker, powered by Markt&Technik are copyrighted. We reserve all rights to all such texts, including translations. Any kind of duplication, whether photocopies, microfilm or recording in data processing systems is only permitted following written approval by the publisher and editor.

An operated solution or used description should not be constructed as free from industrial proprietary rights on the basis of this publication.

Liability: In the event that Rutroniker, powered by Markt&Technik contains inaccurate information or if published programmes or advertisements contain errors, the publisher, its employees or the editor shall only be liable in case of gross negligence.

Circulation: 27,000 (German) + 1,000 (English)

Special thanks:

Kathrin Scheider – Rutronik, Project Coordinator, Strategic Marketing  
 Achim Grolman, Markt&Technik  
 Christian Stadler, Markt&Technik

**List of advertisers**

Apacer Technology B.V. ....	89
Bosch Sensortec GmbH ....	13
Christine Schulze PR   Kommunikation ....	73
C&K Components SAS.....	7
Eaton Electrical Products Ltd ....	31
F&S Elektronik Systeme GmbH ....	63
INFINEON Technologies AG ....	92
INTEL Corporation (UK) LTD ....	46–47, 91
JAE Europe Ltd. ....	9
Kingstate Electronics Corporation ....	15
Kioxia Europe GmbH ....	5
Kontron Europe GmbH ....	75, 79
KYOCERA AVX Components Corporation ....	19
Littelfuse Europe GmbH ....	51
Lumberg Connect GmbH ....	3
Melexis Technologies NV ....	65
Molex Interconnect GmbH ....	17
Murata Electronics Europe B.V. ....	21
Nordic Semiconductor ASA ....	61
Omron Electronic Components Europe B.V. ....	27
Ramses Keystone Electronics ....	83
RECOM Power GmbH ....	35
Renata AG ....	77
ROHM Semiconductor GmbH ....	59
Saft Batterien GmbH ....	33
Samsung Electro-Mechanics GmbH ....	49
Sensirion AG ....	37
Solidigm™ ....	41
TDK - Micronas GmbH ....	85
Transcend Information Trading GmbH ....	67
Vishay Europe Sales GmbH ....	43
Yageo Corporation ....	2

Ethernet transformers

# High quality due to automated production

*As the interface between the device and the Ethernet cable, Ethernet transformers perform a key role. Thanks to a new design, they are now available in large quantities and high quality for the fast-growing market of Ethernet networks.*

BY JOCHEN NELLER, TECHNICAL EXPERT  
INDUCTORS AT RUTRONIK

Based on the advances in production technology and the introduction of efficient coding processes, modern-day Ethernet networks can achieve transmission rates of up to 40 Gbit/s and 100 Gbit/s for copper and fiber-optic networks respectively. The widespread use of Ethernet enables the most cost-effective digital networks. So, it comes as no surprise that the number of Ethernet networks is increasing all the time. Consequently, the vast majority of end devices for industrial, communication, transportation, and consumer markets is interconnected via Ethernet networking.

A critical component used in Ethernet networks is the transformer. As the interface between the device and the Ethernet cable, it performs a key role: It provides safety-relevant galvanic isolation between digital circuitry, which forms the data link layer for Ethernet systems, and PHY (physical layer)

(Fig. 1), which converts digital signals to analog ones. At the same time, the Ethernet transformer is responsible for impedance matching and data transmission. The transmit and receive signals should be attenuated as little as possible.

The transformer consists of four windings, of which two windings are used on the primary side for the digital interface, and the other two windings are on the secondary side connected to twisted pair wires via the RJ45 connector.

The H1190NL transformer from Pulse, which provides 1,500 V rms or 2,250 V DC electrical isolation as specified by IEEE 802.XX, derived from IEC standard 62368-1, eliminates potential high-voltage exposure caused, for example, by electrical shorts in building wiring. This is accomplished by a magnetic coupling that allows transfer of electrical signals

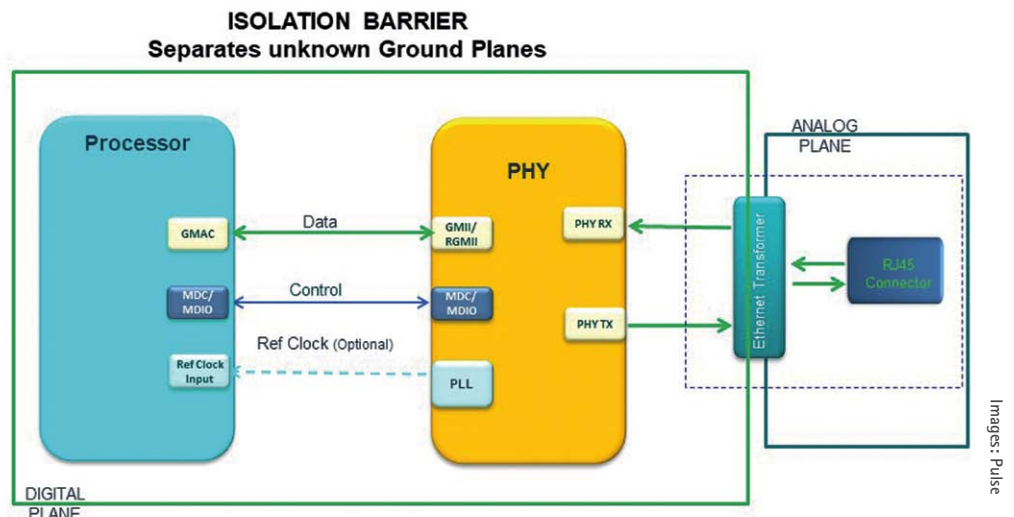

Figure 1: The transformer isolates digital circuitry from PHY (physical layer).



Figure 2: Transformers wound semi-automatically (a) and fully automatically (b).

from the primary to the secondary side while providing the required safety function.

*Higher quantities and improved quality thanks to automated production*

Until quite recently, the amount of manual labor involved in the production of ferrite toroidal core transformers was still relatively high, since the magnet wires had to be connected to the contacts and pins by hand – a time- and cost-intensive process. Further, the risk of impedance mismatch is very high in manual production processes, which can cause a decrease in both the maximum usable bandwidth and the data transmission rate. To meet the increasing demand for transformers while improving component quality, Pulse invested in automated transformer winding equipment for the production of the T-chip series (TC1000/2500/5000/10000) (Fig. 2). The transformers are now wound fully automatically onto a bobbin-shaped core with plated contacts for wire terminations. Another advantage of fully automated production: A visual inspection to ensure correct winding is no longer required.

In addition to lower costs resulting from shorter production times and improved production yield, the T-chip series transformers offer many other advantages. The technology integrates the mechanical package around the ferrite core, thereby eliminating the need for a plastic housing. The transformers are thus lighter and smaller compared to traditional toroidal core models.

Generally speaking, T-chip transformers support the same data rates as toroidal core designs. Moreover, they meet standards IEEE 802.3xx for data transmission rates of 100 Mbit/s to 10 Gbit/s and provide up to 600 mA of PoE (power over Ethernet) to power remote end devices.

*Quality features of T-chip transformers*

In addition to crosstalk, common mode rejection, and return loss, a decisive quality feature

of transformers is insertion loss. It describes the loss of transmission power from the power source to the load and represents the transmitted signal power that is lost between input and output. The insertion loss is closely related to the possible range or cable length.

The diagrams in Fig. 3 illustrate the insertion loss of 1 Gbit/s transformers, once with a toroidal and once with a T-chip design. The measurement curves show that LAN transformers with a T-chip design have a reduced scatter of electrical parameters and better values.

*Summary*

T-chip technology enables the production of high-quality Ethernet transformers for a myriad of networking applications. Beside the quality of the components, an EMC or RF-compatible environment and an appropriate PCB layout are crucial factors to guarantee top-quality Ethernet networks.

Figure 3: Comparison of insertion loss for toroidal and T-chip transformers.

**1Gbps transformer Insertion Loss using Toroidal core**

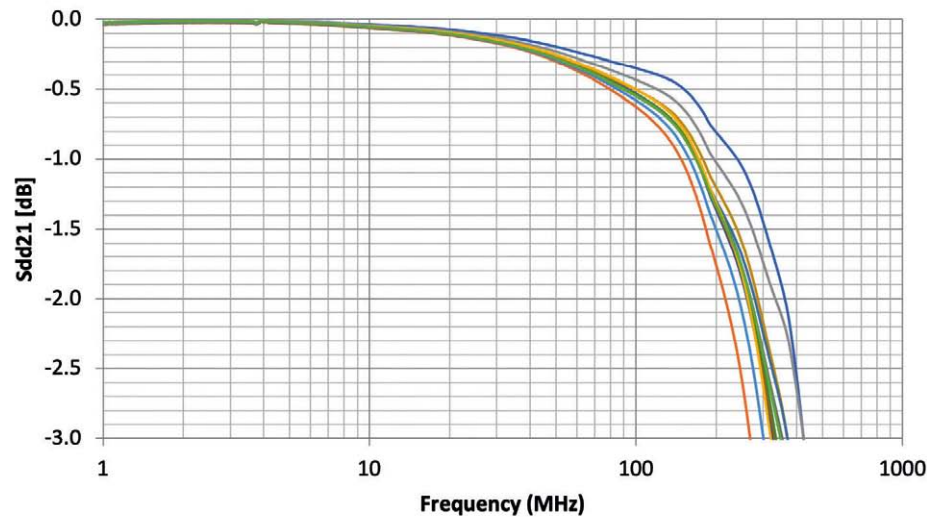

**1Gbps transformer Insertion Loss using T-Chip Technology**

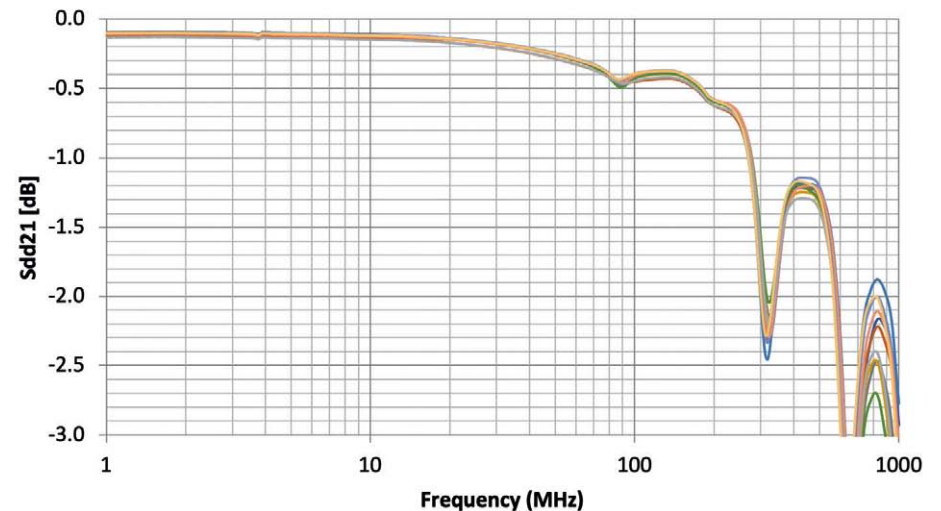

Taking a look at the electronics supply chain

# “The market has to become more resilient”

*Everyone knows that the situation has been challenging in recent months. Now things seem to be easing up a little. Nonetheless, our infrastructure will need to be more resilient in the future. We talked to Jan Stoll, Project Coordinator Strategic Marketing at Rutronik, and Andreas Mangler, Director Strategic Marketing and Member of the Extended Executive Board at Rutronik, about the key factors, measures, and developments.*

**Jan, Andreas, what can those involved in the electronics supply chain do to prevent the kind of delays and price hikes that we have seen in recent months?**

*Jan Stoll:* Companies have limited room to maneuver. This quickly becomes evident when you take a look at the influencing factors that have contributed to the current situation.

**Do you mean the COVID-19 crisis and the war in Ukraine?**

*Stoll:* They are crucial external factors. However, the fact that they have had such an extreme impact is down to the actual electronics market. It commences right at the very start of the value chain, with the raw materials. They can only be found in certain countries, thus creating a great deal of dependence. Roughly 60% of the rare earths are mined in China. Vietnam, where the strong influence of China, Brazil, and India can be felt, also plays a key role. Russia contributes a large share of platinum-group metals. Empty stocks caused by mounting sanctions will also lead to shortages and price hikes in this sector.

**Nothing can be done about where these elements and minerals are found.**

*Stoll:* That is true. However, it is primarily the political conflicts that are causing the problems. And there is definitely a dominance of a few companies and countries along the value chain of the semiconductor industry: Worldwide, for example, there are only a handful of wafer suppliers. Most of them are located in Asia; GlobalFoundries, for instance, is the only US company. Taiwan alone accounts for more than 66% of global semiconductor production, and so the country obviously plays a major strategic role.

**The EU Chips Act is an attempt to reduce this level of dependence. What is your opinion on this?**

*Stoll:* I believe it is a wise step. In Germany, for example, the Federal Ministry for Economic Affairs has also launched a range of programs to attract electronics suppliers. This type of investment support is necessary since development of a semiconductor fab costs between \$15 and \$20 billion. That is also the reason for the concentration: To earn economic profit from these investments, semiconductor fabs need to operate at no less than 80 to 90% capacity. This means, on the one hand, that they inevitably have to serve the global market to achieve the necessary quantities and, on the other hand, that there is hardly any room for maneuver to increase production. Moreover, it takes years to construct new semiconductor fabs. That is why the EU Chips Act will only have an impact in the long run.

But even then, we should not expect too much, since numerous other countries are also offering subsidies and tax breaks to companies: for example, the USA with the Chips and Science Act, China with “Made in China 2025”, as well as Korea, Taiwan, and Japan. The USA can also boast initial successes with some noteworthy investments from TSMC, Samsung, Intel, and Micron. In Europe, Intel, GlobalFoundries, and STMicroelectronics are all planning new plants. This also shows that it is often non-European companies that are setting up operations here, something that reduces our dependence to a limited extent only.

**Why are so few European businesses involved?**



Andreas Mangler,  
Director Strategic Marketing at Rutronik

“Maybe the momentum will continue, and we will enter a period of constant ups and downs.”

*Stoll:* Semiconductor production is an extremely complex process; roughly 1,500 steps are required to produce one chip. This obviously requires a very high standard of knowledge – there is a reason why suppliers spend about 20% of their total expenditure on research and development. And this know-how is basically only available in manufacturing companies. The smallest structures are produced by TSMC. In other countries, the company generally uses older production processes – thereby ensuring the expertise remains in Taiwan.

The processes are, by the way, also very sensitive. For example, the cold snap in Texas during the winter of 2021/22 forced the shutdown of production at some electronics companies. And seeing as this can cause irreparable damage to the wafers, they usually have to be disposed of and production completely restarted. This means the usual production period of more than 20 weeks is accompanied by huge losses and waste – with



Jan Stoll, Project Coordinator  
Strategic Marketing at Rutronik

“The dip in growth and the many investments in new semiconductor fabs will certainly cause prices to fall in the long term.”

corresponding delivery issues and price increases. This is also true in countries, for instance in the ASEAN region, that experience heat waves, earthquakes, floods, or typhoons. The local concentration of companies aggravates this situation. Greater regional distribution and more independence are thus essential! For this to succeed, students must be equipped with the necessary skills and knowledge at local universities and be retained here once they have graduated.

**It will take years or decades before this knowledge translates into products. Will Europe remain dependent on Asia and America until that point?**

*Stoll:* This needs to be considered in a differentiated way, since semiconductor suppliers also have to deal with dependencies. We have already talked about the raw materials, and wafer production is also very energy intensive. It is, therefore, possible that the war in Ukraine will have a direct impact on prices in the medium term. If there were to be a shortage of gas that also affected gas supplies to industrial customers, it would hit the entire electronics industry hard.

A further problem is that machines and systems for wafer production are also supplied by a very small number of highly specialized companies, which basically have a monopoly in this field. One of them, ASML, is located in Europe, while several others are based in the USA. This is where the cat bites its own tail: Because ASML only produces small quantities, the company is a typical distribution customer. If chip and component suppliers primarily supply their major direct customers, resulting in distribution shortages, their own suppliers may be affected. Nevertheless, it is important to make a distinction between components and markets.

**Are there any to which this does not apply?**

*Mangler:* The differences are rather gradual. What my colleague just described applies, above all, to very small designs and structure sizes as used in the PC and consumer goods market. The industrial and automotive markets tend to use larger designs and structures, such as those produced by European companies like Infineon, ams Osram, and Elmos. There are overlaps in some applications, though. For example, the camera systems or graphics cards for driver assistance systems in cars and for PCs are practically the same, albeit in different qualities.

In the power sector, too, the focus is on larger structures, such as those produced by Rohm with SiC or Infineon with GaN. Once again there are overlaps, as the products are used, for example, in applications in the fields of renewable energies and electromobility, as well as in power supplies for laptops, etc. The fact that they are also produced in Europe is advantageous for these segments. However, they will only benefit to a limited extent from the current easing up of shortages.

**Why?**

*Stoll:* Because it mainly affects PCs, smartphones, and consumer goods. Working and schooling from home caused demand for these devices to skyrocket before the market slumped by 60% year-over-year in the first quarter of 2022. The demand for servers and high-end processors for the generation of crypto currencies has also witnessed a sharp decline, as interest rate hikes have led many investors to turn increasingly to traditional forms of investment. However, the industrial and automotive market is hardly able to make use of the freed-up capacities due to the different designs and structure sizes. And suppliers are not really in a position to start making demands: The European automotive industry accounts for a share of just 3% of the global market for electronic components. And the share of the European market as a whole is only 8%. In comparison: That is roughly the same amount of electronic components that Samsung or Apple alone require.

**What else can European companies do?**

*Mangler:* Second source or redesigns could be a selective solution. Some of them are dealing in the gray market but obviously have to accept the very real risks of receiving counterfeit or defective goods. As mentioned, the options are limited, the market reacts too sluggishly, and is just not resilient enough. You can compare it with road traffic: Each vehicle travels

independently, but they all use the same road and are, therefore, dependent on each other – and the greater the volume of traffic, the higher the level of dependence. If only one vehicle is forced to slow down too much, it can quickly cause a very long tailback. This inflexibility is also due in part to the inventory control systems and their parameterization in the procurement processes.

**Please continue ...**

*Mangler:* They employ insufficient dynamic, customizable functions and too many static limits. Further, long-term planning horizons of one to two years are important. However, this also requires awareness of what is currently going on and a good understanding of the market in order to assess the various factors properly. But ultimately, there also needs to be a "frozen window" within which the forecast is no longer changed and the order is fixed.

**Let us take another look at the current situation. What new developments can we expect to see?**

*Mangler:* We are seeing a trend toward normalization emerging. This is clearly illustrated, for example, by the Purchasing Managers Index (PMI), for which data are compiled by IHS Markit for more than 40 economies worldwide. The indices vary from 0 to 100, with 50 being a neutral number of no change. In July 2022, the figure was just below 50 for Europe and Germany, as well as for China, down from around 60. Demand is, therefore, normalizing worldwide and will stagnate or achieve slight growth in 2023. Gartner has lowered its growth forecast for semiconductor revenue from 13 to 7.4%. Growth segments can certainly be identified, such as industrial robotics, but also saturated markets, such as PCs or smartphones, with a forecast increase of just 3%.

The actual delivery situation has also improved: Ports are basically back to normal operation, goods are arriving on time, and container prices and freight costs have fallen. These developments will lead to higher availability and shorter delivery times for some components by 2023 at the latest, but there will be an allocation of many other goods for longer.

**Will this also translate into falling prices for components?**

*Stoll:* The dip in growth and the many investments in new semiconductor fabs will certainly cause prices to fall in the long term. However, based on our observations, the price



increases should have been even higher than they actually were due to the sharp rise in energy and raw materials prices. It is, therefore, possible that prices will again rise marginally, albeit with a slight delay. Falling prices could also become a threat to some companies in the current situation.

#### **What are your thoughts on this?**

*Mangler:* In 2021, there was a 25% increase in the semiconductor sector. We saw strong growth in prices but very restrained unit growth, which led to a sharp rise in the value of a warehouse. And now, every company with stock has to see how it can sell expensive goods at a reasonable price. It is quite possible that this will cause cash flow problems for certain companies in the value chain.

Something else that stands out when you think of storage: For the first time ever, the inventory value in distribution is at the same level as in the global EMS sector. This is due to the fact that many EMS companies bought a lot of goods as a precaution; however, some things have remained in stock, since production is still hampered by other missing parts. An exact analysis of volumes and purchase price trends is important to get an accurate picture of the current situation. That is the only way to make a reliable assessment of the extent to which the forecasts for the next three quarters remain valid.

#### **Are you prepared to make a long-term forecast?**

*Mangler:* Making predictions is never easy – especially at the moment. The scenarios outlined assume a situation in which there is sufficient gas to go round and there are no more military conflicts. It is therefore essential to keep a very close eye on the global political situation. Maybe the momentum will continue, and we will enter a period of constant ups and downs. However, there is relative agreement among market researchers regarding the long-term average. They predict an average increase in the semiconductor sector of 8 to 13% over the next few years – in other words, good, healthy growth.

The sector of passive and electromechanical components will also benefit from this level of growth; as a broadliner, we can add to this. In the wireless and embedded IIoT sector, we see even more positive developments on the horizon. ■

# Lorem ipsum...

...dolor sit amet, consectetur adipiscing elit. Aenean commodo ligula eget dolor. Aenean massa. Cum sociis natoque penatibus et magnis dis parturient montes, nascetur ridiculus mus. Donec quam felis, ultricies nec, pellentesque eu, pretium quis, sem.

## SO THAT THIS DOES NOT HAPPEN TO YOU:



Christine Schulze

[WWW.CHRISTINE-SCHULZE.COM](http://WWW.CHRISTINE-SCHULZE.COM)

Components for onboard chargers

# What is actually needed to ensure efficient charging of electric vehicles?

*Every all-electric vehicle has one and it often determines the charging time at the AC Wallbox: the onboard charger (OBC). High-performance components are needed to make it compact, lightweight, efficient, and quiet.*

BY RALF HICKL,  
PRODUCT SALES MANAGER  
AUTOMOTIVE BUSINESS UNIT (ABU)  
AT RUTRONIK

**F**or BEVs (battery-electric vehicles), low power (kWh/km) is a must. Its calculation often not only includes the power from the battery but also the power required by the AC Wallbox to charge the battery. Charging losses in the OBC therefore impact this figure directly. To ensure a low power BEV, it is essential to have the most efficient charger possible onboard.

The block diagram (Figure) shows a bidirectional, 3-phase onboard charger. Beside battery charging, bidirectional chargers also allow the reverse flow of power from the vehicle battery to the grid. BEVs can thus help buffer the grid at peak load times. Yet another option is to use the vehicle as a power generator in isolated operation, a method Sono Motors is pursuing for its Sion, for example.



Image: shutterstock.com/smile fight



Supplier	Series	Properties/description
Panasonic	ECQUA	Film, Class X2
Vishay	AY1	Ceramic Disc, Class X1, Y1
Vishay	AY2	Ceramic Disc, Class X1, Y2
Kemet	R53	Film, Class X2

Table 1: Series proposals for interference suppression capacitors (Y, X) qualified to DIN IEC 60384-14 and AEC-Q200

Supplier	Series	Properties/description
Rohm	SCT3xxx, SCT4	SiC Power MOSFET, 650 V, 1,200 V, 1,700 V
Bosch	BT1Mxxxx	SiC Power MOSFET, 750 V, 1,200 V
Infineon	CoolMOS CPA, CFDA	Si Power MOSFET, 600 V, 650 V
Infineon	CoolSiC MOSFET	SiC Power MOSFET, 1,200 V

Table 2: Power MOSFETs

In this case, an OBC with four main blocks is recommended.

*Block 1:  
Filter and PFC*

Block 1 contains the filter for suppressing conducted electromagnetic interference (EMI filter). With regard to grid impacts, the OBC must comply with standard IEC 61851-21-1 (Electric vehicle onboard charger EMC requirements for conductive connection to AC/DC supply).

Together with the transistors of the grid inverter, the inductors are also part of the power factor correction (PFC).

*Block 2:  
Grid inverter*

Block 2 consists of the grid inverter. Depending on the direction of power flow, it works as a rectifier or inverter. Through pulse width modulation (PWM) of the input transistors, it

simultaneously ensures high power factor correction (PFC) in interaction with the inductors in the phase lines.

Basically, the trend is toward higher switching frequencies (carrier frequency of PWM). The higher the switching frequency,

- the smaller the passive components can be,
- the quieter the vehicle (anyone who has walked passed a StreetScooter in idle mode or an active first generation high-power charger knows what is meant),
- the greater the power density of the overall system,
- and, unfortunately, the greater the switching losses.

High switching frequencies are enabled by wide-bandgap semiconductors, i.e. diodes and MOSFETs made of silicon carbide (SiC) or gallium nitride (GaN). Automotive-qualified SiC-based MOSFETs are offered by Rohm and Infineon, for example (Table 2).

Image: Rutronik

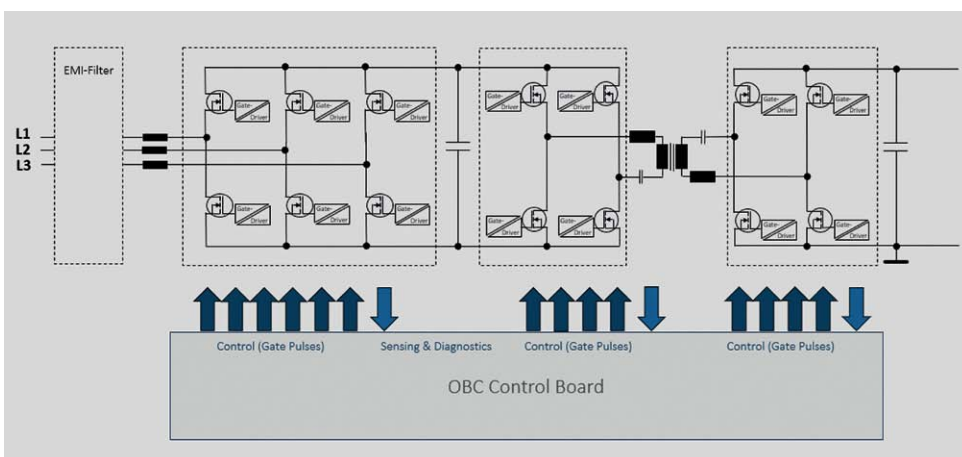

Simplified block diagram of a bidirectional charger.

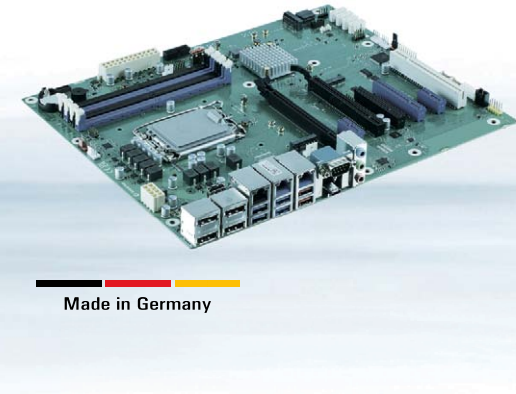

Increase the performance of your application with the new ATX Motherboard K3851-R ATX supporting the 12th Gen. Intel® Core™ i series processors

### HIGHLIGHT FEATURES:

- ▶ Impressive power through Intel® Multi-core technology  
Up to Core i9 processors with 16 cores & R680E chipset
- ▶ High expandability for demanding applications  
3x M.2 (Key-M & Key-E), PCI Express® Gen5 with 16 Lanes
- ▶ Extended network interfaces for high speed data transfer  
Triple LAN 1GbE/2.5GbE incl. Teaming and TSN support

[www.kontron.com](http://www.kontron.com)

Supplier	Series
Rohm	BM61S/MxxRFV
Infineon	EiceDriver

Table 3: Isolated gate drivers

Supplier	Series	Properties/description
Wima	DC-Link MKP4	Film, THT
Vishay	MKP1848 DC-Link	Film, THT
Vishay	MKT1820	Film, THT
TDK	CeraLink	ceramic, THT, SMD, high temperatures, low ESL

Table 4: Power film capacitors

Supplier	Series
Wima	MKP10, FKP1
Vishay	MKP385
TDK Epcos	B32641B ... B32643B

Table 5: Resonance capacitors for CLLC circuit

Supplier	Series	Properties/description
Infineon	Traveo T2G	32-bit microcontroller with core(s) from Arm
Infineon	Aurix A2G	32-bit microcontroller with Infineon Tricore(s)

Table 6: Microcontrollers for control electronics

They are available with ever smaller  $R_{DSon}$  and lower gate-drain capacitance to gate-source capacitance ratio. Small  $R_{DSon}$  counteracts conductivity losses, while small parasitic capacitances in the MOSFET benefit switching losses and switching behavior. The possible elimination of negative gate voltages simplifies the circuitry design for the gate driver and is easy on the budget.

Rohm supports its latest generation of SiC MOSFETs with a half-bridge evaluation board (e.g. P04SCT4018KE-EVK-001), which can be flexibly configured for various gate voltages.

SiC MOSFETs require suitable gate drivers with galvanic isolation between switching and control potential. They provide the necessary gate voltages and currents to reliably switch the MOSFET on or off. Some models also feature additional functions, e.g. monitoring for overcurrent or desaturation (DESAT) with feedback of the diagnosis to the control electronics (Table 3).

The grid inverter feeds the DC link on the grid side. There is also a DC link on the battery side, namely that of the traction inverter. The voltages in both DC links are smoothed and buffered with capacitors. The alternating currents (ripple currents) caused by the grid inverter and the DC/DC converter flow through these DC link capacitors. Important selection criteria for low power loss and heat generation are,

therefore, low ESR (equivalent series resistance) in the switching frequency range and low ESL (equivalent series inductance). Film capacitors meet these property requirements. Alternatively, new ceramic capacitors with a special dielectric from TDK Epcos are available (CeraLink). Unlike conventional ceramic capacitors, their capacitance is not reduced by a high charge with DC voltage (DC bias) but increases up to the nominal voltage level (Table 4).

.....  
*Block 3:  
 DC/DC converter*  
 .....

Block 3 is the DC/DC converter in CLLC topology. It consists of a half-bridge, an AC-coupled pulse transformer, and a synchronous rectifier (half-bridge) on the battery side.

The DC/DC converter adjusts the voltage levels of the grid-side DC link and battery, transferring power from the primary to the secondary side (charging) or vice versa (generator / isolated operation or grid feed-in). The pulse transformer also galvanically isolates the electrical system from the public grid. Together with the capacitors of the series resonant circuits, the pulse transformer has a significant impact on the efficiency and power loss of the converter since the entire transmitted power flows through both components. An important selection criterion for resonant capacitors is,

therefore, their loss factor  $\tan \delta$ . The smaller the loss factor, the lower the capacitor power loss and the better the efficiency. Together with the capacitance required for the resonant frequency, these conditions usually lead to the choice of film capacitors (Table 5).

Like the resonant capacitor, the pulse transformer is also a high-performance component. To achieve high efficiency, it must also generate as little heat as possible, i.e. offer low power loss. The power loss is composed of core and copper losses. While eddy current losses and remagnetization losses contribute to core losses, copper losses are determined by the ohmic resistance of the winding according to  $P = I^2R$ . Due to the skin effect, the resistance depends on the frequency and increases with rising frequency.

The core material of the pulse transformer should be characterized by high saturation field strength and low remanence with high permeability. The higher the permeability of the core material, the fewer windings a coil requires to achieve a given inductance. Shorter coil wires, which have a lower resistance, are sufficient for a coil with less windings. A high saturation field strength allows for the core material to be designed in a highly controlled manner. Thus, a large portion of power can be transferred per period. High electrical resistance of the core counteracts eddy current losses. Its design ideally ensures defined leakage inductances on the primary and secondary side. Together with the resonant capacitor, the leakage inductance forms the resonant circuit. Alternatively, a low-leakage core can also be used. However, in this case, separate resonant inductances are required.

The densest possible winding, a rectangular conductor cross section, or a band result in a short conductor length and a high degree of filling of the coil former.

A pulse transformer with a compact design is advantageous for automatic printed circuit board assembly. Rutronik helps its customers find the pulse transformer that ideally matches the individual design. Sometimes a bespoke design is necessary. The suppliers TDK, Vishay, and Pulse are at hand as development partners for such pulse transformers.

.....  
*Block 4:  
 Control electronics*  
 .....

Block 4 shows the control electronics. Based on measured values, a microcontroller gener-

Supplier	Type	Properties/description
Vishay	VOMA617A	Optocoupler with photo transistor output, AEC-Q
Vishay	VOA300	Linear optocoupler, AEC-Q version of IL300
Toshiba	TLX9xxx	Transistor or IC output, AEC-Q

Table 7: Signal isolators

Supplier	Series	Type	Properties
Amphenol	ExcellMate	HVSL xxx	for high voltages, Safety Lock, LV-215

Table 8: Plug-in connectors for high voltage applications

ates the control signals for the power semiconductor in the inverter, the DC/DC converter, and the synchronous rectifier. Depending on the functional safety requirements, derivatives from Infineon's Traveo T2G series (up to ASIL B) or from the Aurix A2G series (up to ASIL D) are suitable (Table 6).

On their way from the high-voltage side to the control side with non-hazardous low voltage, the signals must be galvanically isolated. Components for the galvanic isolation of signals are, e.g., optocouplers from Vishay or Toshiba. Vishay's VOA300 is an optocoupler for the transmission of analog signals and the automotive variant of the well-known IL300. It includes a transmit LED and a pair of matched receive LEDs. If one of the receive LEDs is included in a negative feedback circuit on the control side, good linearity of the current transfer characteristic between the transmit LED and the second receive LED is achieved (Table 7).

### HV connectors

The HV connectors from Amphenol (Table 8) must be mentioned in this respect. They ensure compatibility with Webasto's Vehicle Interface Box, which is used by numerous OEMs and conversion specialists.

### Evaluation boards

As with the design of a bidirectional HV switch for 800 V/50 A (page 53), Rutronik Automotive is collaborating with its partners on a reference design for an OBC. The design of the HV switch combines the functions of a conventional fuse with those of a switch. Cutting-edge 1,200 V SiC MOSFETs provide low conductivity losses and low power loss, thus making passive cooling sufficient. Until Rutronik's new reference design for the OBC has been completed, Infineon's REF-DAB-

11KIZSICSYS illustrates the implementation of a bidirectional 11 kW DC/DC converter in CLLC topology with 1,200 V and 1,700 V Cool-SiC MOSFETs.

### Summary

The long-term development of the OBC is quite exciting: Does it migrate into the charging cable as a kind of plug-in power supply thanks to modern components with high power density? Will it be just an equipment option in the future due to the development and spread of the charging infrastructure? Since during the journey it is basically just useless ballast. It competes with DC charging stations that bypass it and with battery swap technology. But as long as it is needed, it should be as efficient as possible. ■

Advertisement

# We develop batteries for smart, industrial and medical needs.

We are a worldwide leading Swiss manufacturer and supplier of primary and secondary batteries. We draft, develop and produce standard and customized battery solutions for customer's needs. For more information contact us:

[www.renata.com](http://www.renata.com) | [sales@renata.com](mailto:sales@renata.com) | +41 619 75 75 75



Lithium primary thin film cells for smart cards, smart patches and logistic tracking labels



Lithium-ion pouch and coin cells for energy harvesting and portable devices



High performance silver oxide coin cells for medical sensors and fitness devices



High performance primary coin cells for applications such as medical, automation, timekeeping and remote devices

**renata**  
batteries

Charging port for electric vehicles

# Why charging is not just Refueling 2.0

*What's so special about a charging port for electric vehicles compared to the fuel nozzle for conventional ones? Not much at first glance, and as such the charging plug was simply placed behind the tank cap on the first electric vehicle models. But this is not ideal, especially with regard to safety aspects.*

BY THOMAS KEPČIJA, CORPORATE PRODUCT  
MANAGER ANALOG & SENSORS  
AT RUTRONIK,  
JENS SCHUBERT, PRODUCT LINE MANAGER  
DIRECT ANGLE, AND  
BERKO KLETZANDER, PRODUCT LINE  
MANAGER EMBEDDED CONTROLLER,  
BOTH AT TDK-MICRONAS

**T**he biggest difference between a fuel filler flap and a charging flap is their frequency and time of use. While a fuel filler flap is opened and closed maybe once or twice a week on average, it happens on a daily basis with a charging flap. The charger is unplugged at the start of a trip and plugged back in at the end of the day. And if you are on the road a lot or take longer trips, you will also

have to open the flap somewhere along the way for recharging.

*First impressions count*

In this context, another aspect plays a vital role. With an internal combustion engine vehicle, the first contact is always opening the

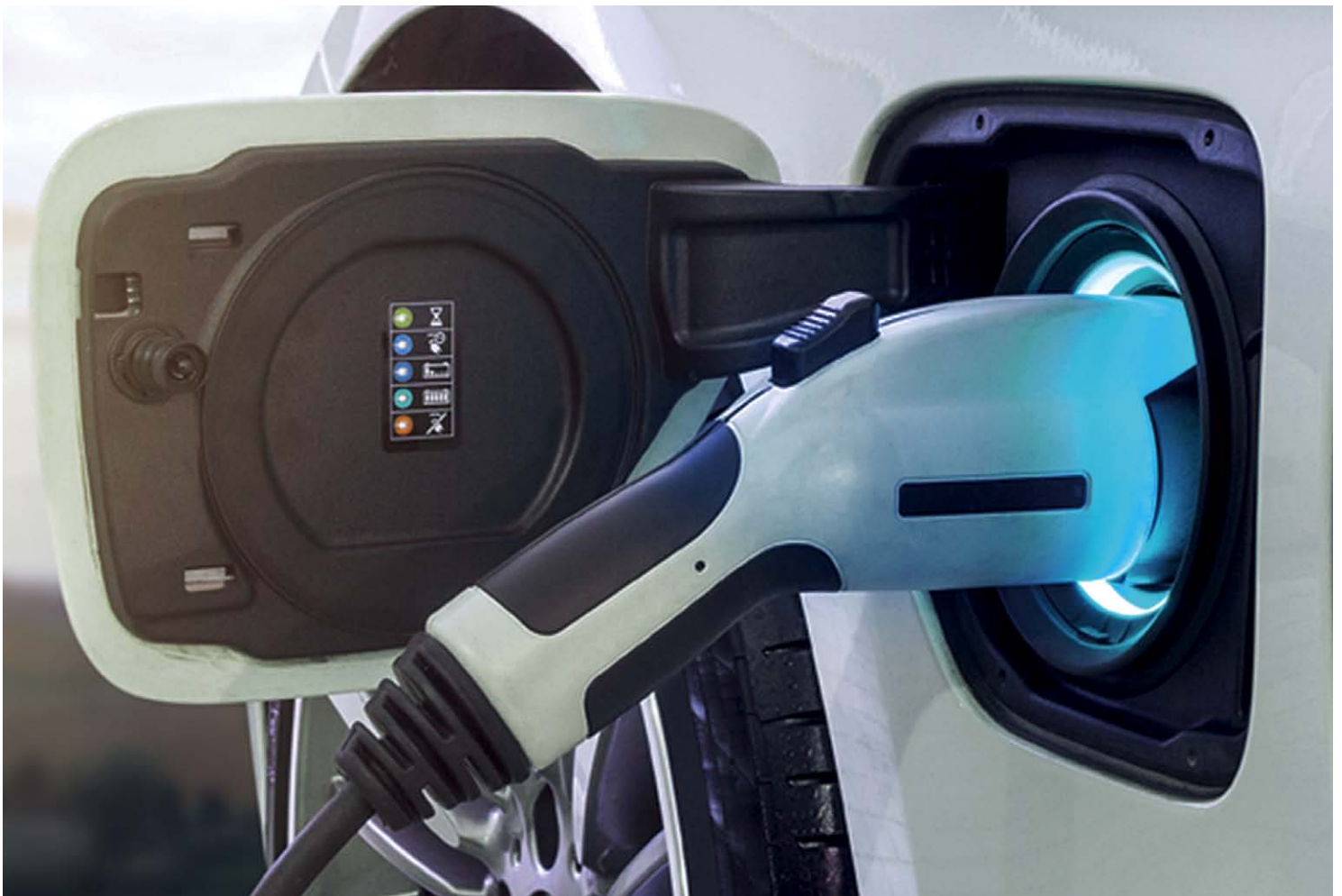

Image: TDK-Micronas

# KSWITCH

## D10 MMT FAMILY



door and getting into the driver's seat. That is the reason why car manufacturers go to great lengths to make it a positive experience – after all, there is no second chance for a good first impression! This is different with electric cars: In this case, the driver should first disconnect the charging cable before getting into the car, otherwise it is going to be somewhat of a short ride. This obviously turns the charging flap into the vehicle's calling card. Car manufacturers have recognized this fact and are trying to make the charging experience as positive as possible, especially for high-end vehicles.

First and foremost, it includes ensuring that the charging port meets vehicle safety requirements. To protect users from electric shock, the port must be waterproof.

---

### *Firm connections are decisive*

---

In addition, the plug must remain connected during the charging process. After all, there is hardly anything more annoying for electric car drivers than approaching a presumably fully charged vehicle only to find that the plug has become loose or someone else has unplugged it and the car is only partially charged. This makes the locking of the charging plug one of the most important parts of the charging port. Electronics integrated in the actuator control this process and enable the current status to be queried.

However, disconnecting the plug during the charging process is not just annoying for the driver. It can also damage the charging electronics and cause an arc, destroying the connector plug or causing skin burns. Therefore, a functional safety rating of ASIL applies to the charger; the requirements for the application being addressed may vary between a QM product and a product with "ASIL B ready" as a prerequisite.

---

### *Key components*

---

All charging ports require at least two electronic components that are not required in vehicles with an internal combustion engine: an actuator for locking and a plug sensor.

The charging plug is securely locked by the movement of a metal pin inside the charging socket via an electric actuator. To control the motors that move such pins, TDK offers various integrated Arm Cortex-M3 motor controller ICs through its HVC-4x family. They are

capable of controlling DC, BLDC, and stepper motors while connected to a LIN bus (automotive version). Six motor outputs enable the control of up to three independent DC motors, e.g. for locking the plug and the charging flap or for electrically opening the charging flap. Seven general-purpose IO pins can be used to control warning and charging LEDs and to interface with various sensors, such as the sensor that ensures the locking pin is actually inserted into the plug.

This safety check can also be implemented using a Hall effect sensor. To do so, the TDK portfolio includes several 3D position sensors, e.g. Micronas HAC 373x or HAC 3930. They can measure either the rotation of a gear (in combination with a solenoid) or the linear movement of the locking pin (together with an attached solenoid). Both are ASIL B ready according to ISO 26262 and therefore suitable for applications that need to meet ASIL B requirements. Additionally, both sensors support PWM and SENT interfaces for communicating with the integrated electronics. They feature a small leaded transistor package (TO92UF) with integrated protection capacitors, which enables cost-efficient lead frame assembly and thus more compact actuators.



### INDUSTRIAL ETHERNET SWITCHES WITH TSN-FUNCTIONALITY

- ▶ Full Time Sensitive Networking feature set and management
- ▶ Support of all TSN standards (e.g. IEEE 802.1 AS, 802.1Qci etc.)
- ▶ 6x 1000/100/10Base-T Ethernet plus 2x 2500/1000/100/10Base-T Ethernet or 2x SFP+ Ports
- ▶ Optional: Netconf implementation for TSN network functions
- ▶ Extended supply voltage and temperature range (-40 °C - 75 °C)
- ▶ Compact, robust metal design
- ▶ Consistent single-chip design

[www.kontron.com](http://www.kontron.com)

DC/DC converters

# Electromobility in harsh environments

*Perhaps the most fascinating example of electromobility occurred in April 2021: the maiden flight of the Ingenuity helicopter on Mars. Although electric vehicles on Earth do not have to operate in such harsh environments, their power electronics still need to work reliably in difficult conditions.*

BY AXEL STANGL, CORPORATE PRODUCT MANAGER POWER AT RUTRONIK, AND STEVE ROBERTS, INNOVATION MANAGER AT RECOM



**W**hen Ingenuity took off on Mars, it was nearly 300 million kilometers away from Earth; the round-trip transmission time of a radio signal exceeded 32 minutes. During its flight, the helicopter consumed about 350 watts of power. The rechargeable lithium-ion batteries driving its two rotors were solar-powered.

The environment on Mars is harsh, with extreme temperatures and low atmospheric pressure, meaning much can be learned about the reliability and durability of the power electronics under challenging conditions through Ingenuity's flight.

*Terrestrial vehicles also have it tough*

There are off-highway vehicles on Earth that operate in harsh environments, too. They include pallet/forklift trucks, loaders, tractors, and excavators, as well as an array of smaller machines for automated tasks or passenger transport. Like Ingenuity, they require motor drives, on-board and off-board chargers, and DC/DC converters to convert the voltage level between the drive battery and 12 V or 24 V for auxiliary equipment. These converter modules typically operate at outdoor temperatures of between  $-40^{\circ}\text{C}$  and  $+75^{\circ}\text{C}$  and are protected against the ingress of dust and water. Cooling is often only provided by a base plate; fans are hardly ever used due to their service life and noise-related properties.



*Electronics to automotive quality standards*

Many advances in the field of power electronics focus on electric vehicle solutions for people and goods. Improving efficiency to increase the range of the vehicles and to reduce the size and weight of the converters is a key factor of this work. This also applies to low-voltage DC/DC converters that also need to work reliably for many decades in the demanding environment of electric vehicles.

Self-driving electric vehicles can be seen as mobile data processors. They are equipped with components typically required for this, such as CPUs, FPGAs, and SoCs, all of which demand low-voltage precision power rails. They are usually provided by point-of-load (PoL) converters. Converters that qualify for this application must ensure the highest level of reliability, e.g. through surface-mount solder connections with wettable flanks.

Further, the operating environment of an electric vehicle is susceptible to EMC (electromagnetic compatibility), and switching frequencies in the AM range can be problematic. The converters must, therefore, be kept within limited frequency ranges, which obviously restricts the circuitry design.

Vibrations and both physical and thermal shocks also pose particular challenges. Recom's high-efficiency RPX series (Fig. 1) is designed to withstand them (according to MIL-STD-883D). It can also be obtained from Rutronik as a Q-version, which meets the re-

quirements of the automotive industry. The RPX is housed in an ultra-miniaturized, 3 mm x 5 mm QFN package that is just 1.6 mm tall with an over-molded flip chip on a leadframe. The output voltage can be trimmed from 0.8 to 30 V, while the input range is 4 to 36 V. It additionally provides comprehensive monitoring and control, something that is essential for electric vehicle applications.

Chargers for electric vehicles, whether for on the road or at home, must be small and should have the least possible impact on the environment. This again requires a high level of efficiency, not only in the main stage of the AC/DC charger, but also in a number of commonly available AC/DC and DC/DC auxiliary power supplies.

Off-board chargers generally operate in an environment of overvoltage category 3 (OVC III). Off-the-shelf AC/DC chargers are, therefore, often not suitable, especially if the charger needs to be bidirectional. The Recom subsidiary Power Control Systems (PCS) specializes in customized products for high-kW applications. The power supplies available through Rutronik meet all relevant standards and feature an operating temperature range from -40°C to +85°C. Beside low noise and low ripple, they are characterized by a high level of efficiency.

*Strict rules for rail electronics*

While helicopters on distant planets do not have to meet international standards on functionality and safety, eMobility applications on

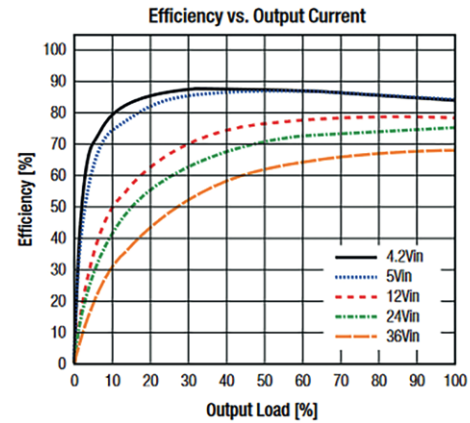

Images: Recom

Figure 1: The RPX-DC/DC converter from Recom is highly efficient (the 1.8 V output version is shown in the diagram).

Earth are often heavily regulated. A prime example is the rail sector: DIN standard EN 50155 is the general standard here; while other standards regulate EMC, insulation systems, shock/vibration, fire protection, and electrical safety features. These standards ensure that power sources for drive, control, comfort, and communication devices operate reliably despite power problems and disturbances, such as transients, spikes, brownouts, and total mains failures, as well as a nominal supply voltage varying between 24 V and 110 V DC (Fig. 2).

To meet these standards, modular converters require a high level of electrical and environmental protection, although only contact cooling is usually available. The DC/DC converters of Recom's RMD family satisfy all these requirements. They are available for applications in the range of 150 W to 1 kW.

The Ingenuity helicopter is certainly an inspiration – but probably very few people outside the energy technology community realize that the technology that made its maiden flight possible is also used in electric vehicles down on Earth.

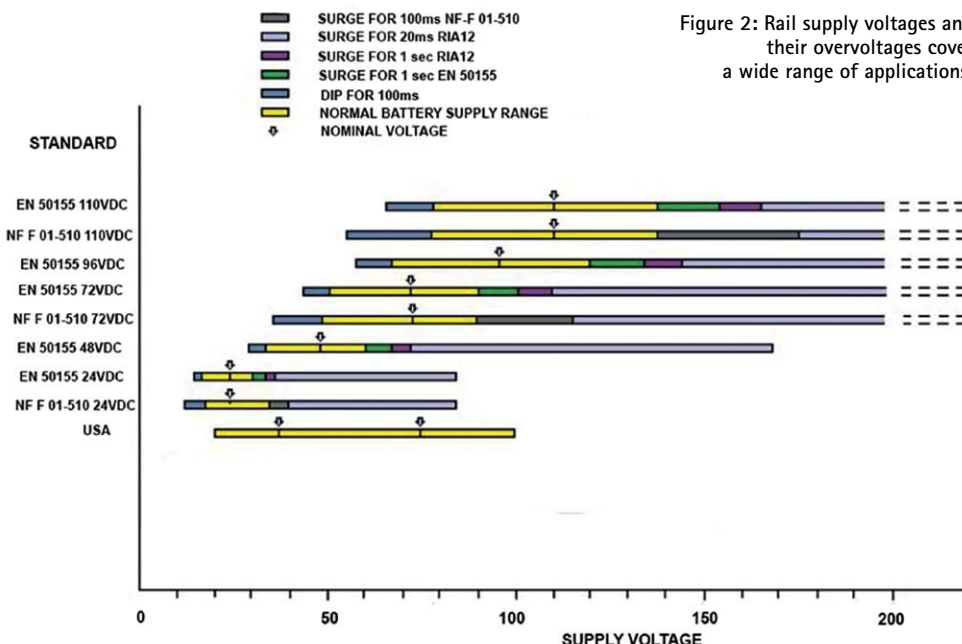

Figure 2: Rail supply voltages and their overvoltages cover a wide range of applications.



Use the QR code or visit [www.rutronik.com/recom](http://www.rutronik.com/recom) to discover more information about Recom, new products, application examples, and how to order from Rutronik.

Greater functional safety in cars

# Mastering ESD for interference-free data transmission

Electronic components currently make up roughly one-third of the value of a passenger car, and this figure is set to rise. Seventeen percent of semiconductor failures in cars are due to electrostatic discharge (ESD). Appropriate protective measures are therefore a must.

By EMILIA MANCE, CORPORATE PRODUCT SALES MANAGER STANDARD PRODUCTS AT RUTRONIK

In everyday life, experiencing a tingling in your fingers or a static shock when touching a car door may be annoying, but for some electronic assemblies, electrostatic discharges can mean total failure. The smaller the semiconductor structures and the higher the impedance of the analog and digital I/O pins, the more susceptible they are. Possible consequences include thermal breakdown of a p/n junction, oxide breakdown (dielectric breakdown), and melting of the metalized layer.

They, in turn, lead to malfunctions, shortened service life and, ultimately, total failure of the semiconductor. Often, the damage is first detected by the customer and then causes high costs for repairing or replacing the device or application.

And this also holds true for automotive applications. The number of electronic systems inside a vehicle has increased rapidly in recent decades. They can be found in engine and transmission control systems, in many control units, in safety technology, and chassis optimization, and even in information and communication technology.

Bus systems are a very central element since they ensure communication between the various systems. Each bus system is optimized for specific properties, such as networking a larger number of ECUs and high data rates (CAN), low-cost implementation, high bandwidth (Ethernet), use in safety-relevant distributed controllers (FlexRay), or low-cost integration of sensors and actuators (LIN).

## Protecting vehicle networks

Numerous suppliers offer ESD diodes specifically designed for each of these systems. In contrast to TVS diodes, they not only protect against voltage spikes but also against data loss.

With Data Line Protection, Diodes has put together a whole range of protection components that strike a chord with users due to

Image: Rutronik

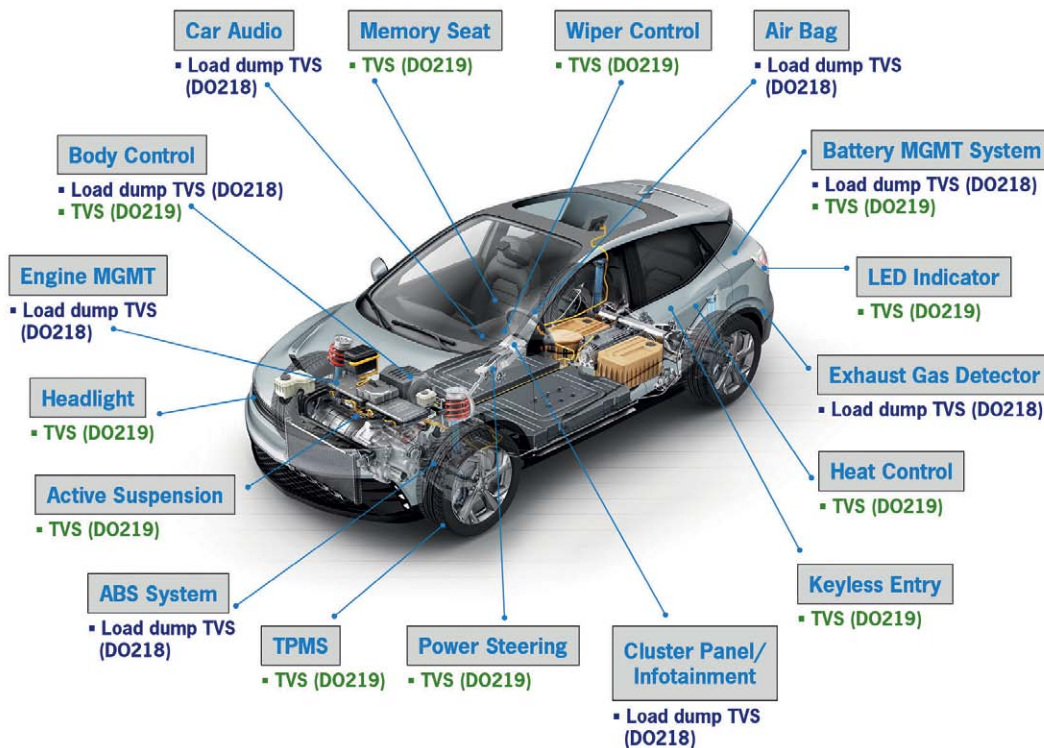

ESD-sensitive applications in the car.

outstanding ESD performance in their class and numerous package options for customer-specific requirements. They are characterized by a low-channel input capacitance. Their breakdown voltage is also designed for car use; the series with the suffix Q are AEC-Q qualified. This includes, for example, DES-D1LIN2WSQ. The bidirectional TVS diode is suitable for protecting the LIN bus; one channel provides ESD protection according to IEC 61000-4-2, i.e. up to  $\pm 30$  kV for air and contact. It is AEC-Q101 qualified, PPAP capable, and produced in IATF-16949 certified facilities.

Littelfuse's AQHVxx-01LTG series, also AEC-Q101-qualified, has been specifically designed for ultra-fast, high-performance surge protection components for the CAN and LIN data bus. The series protects against damage caused by ESD as well as other transient over-voltages. It can safely pass on periodic over-voltage surges above the maximum level according to IEC standard 61000-4-2 (level 4,  $\pm 8$  kV contact discharge) without any loss in performance. Moreover, it ensures safe transmission of induced surge currents of up to

10 A (AQHV12) (IEC 61000-4-5 (2nd Edition):  $t_p = 8/20 \mu s$ ) with an ultra-low clamp voltage.

Vishay also offers a range of AEC-Q101 qualified unidirectional or bidirectional ESD diodes specifically designed to protect the CAN, LIN, or FLEX bus. The VCUT05E1-SD0 ESD diode with an operating range of  $\pm 5.5$  V, for instance, has a low leakage current of less than  $0.1 \mu A$  and a low load capacitance of less than  $14$  pF. Its CLP0603 package is only  $0.27$  mm tall and requires three times less space on the PCB than a 1006 package.

The performance of the bidirectional ESD diodes of the VLIN1616-02G series is specially adapted to the LIN bus. They are available in the small SOD323 package; their operating range is  $\pm 16$  V, their leakage current less than  $0.05 \mu A$ , and their load capacitance less than  $24$  pF. ■

Type of semiconductor	Electrostatic voltage (V) (ESD sensitivity)
V-MOS	30...1,800
MOSFET	100...200
EPROM	100...500
Junction FET	140...1,600
Operational amplifier (FET)	150...500
Operational amplifier (bipolar)	190...2,500
CMOS	250...2,000
Schottky diodes	300...2,500
Film resistor	300...3,000
Schottky TTL	300...2,500
Transistor, bipolar	380...7,000
Thyristor	680...2,500

Semiconductor sensitivity: Electronic components react to electrostatic discharge (ESD) with varying degrees of sensitivity.

Advertisement

IT'S WHAT'S ON THE INSIDE THAT COUNTS

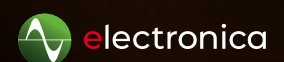

Booth B2.343

European Headquarters: [www.keyelco.com](http://www.keyelco.com) • 33 (1) 46 36 82 49 • 33 (1) 46 36 81 57

Smart eFuse for automotive applications

# More safety for 48 V electrical system architectures

An ever-increasing number of vehicles are equipped with both a 48 V and a 12 V electrical system to operate small and large consumers more efficiently. To ensure safe circuitry, Vishay has developed a high-performance, low-loss smart eFuse board.

BY EDGAR SCHÄFER,  
FIELD APPLICATION ENGINEER AUTOMOTIVE BUSINESS UNIT (ABU)  
AT RUTRONIK

**D**ue to the integration of the 48 V electrical system and the 48 V standard in mild hybrids, protection against over-currents or short circuits also needs to be reassessed, since a greater distance is required between the relay contacts at 48 V (supply voltage) than at 12 V in order to extinguish the arc that occurs when the protective relay is switched. This results in a delayed shutdown and faster wear of the contacts.

Therefore, conventional 48 V relays are replaced with eFuses. They are based on semiconductors and do not have contacts whose wear is fundamentally linked to switching devices. This leads to a longer service life. Furthermore, their faster switching behavior, diagnostic capabilities, and lower tolerances ensure significantly greater safety.

Vishay has developed a smart eFuse that is designed to continuously switch loads up to 200 A at 48 V. The maximum current can be set between 1 and 200 A. If the set value is

exceeded, the eFuse switches within 1  $\mu$ s. In contrast to a conventional fuse, the eFuse can be reset, meaning it does not need to be replaced after tripping.

Even at a switching capacity of 200 A, its power loss does not exceed 14 W. In other words, passive cooling is sufficient up to an ambient temperature of 100°C. Active cooling is only required at higher ambient temperatures.

voltage, the second stage, also known as pre-charging, takes place.

To prevent excessive current caused by capacitive components on the consumer side when the eFuse is switched on, the components are pre-charged via a series resistor until the output voltage corresponds to 85% of the input voltage. Upon reaching this value, the eFuse is switched on.

## Two-stage switch-on behavior

The smart eFuse operates with a two-stage switch-on procedure. The short-circuit test is performed first. During the test, a 13  $\mu$ s pulse is applied via a resistor connected in series. If the output voltage is below 10% of the input voltage, a short circuit is assumed and the eFuse switches off again. However, if the output voltage is above 10% of the input

## Main components of the smart eFuse

At the core of the smart eFuse are 20 N-channel SQJQ160E MOSFETs from Vishay. They are based on the latest TrenchFET Gen-IV technology, which enables a very low  $R_{DSon}$  of just 0.8 m $\Omega$ . As bidirectional MOSFETs, they prevent reverse-current flow when the eFuse is switched off. They come in a compact PowerPAK-8x8L package and operate reliably within a -55°C to +175°C temperature range.

Very low power loss is guaranteed by the high number of MOSFETs connected in parallel with a total  $R_{DSon}$  of 0.3 m $\Omega$ . The temperature of the MOSFETs does not rise to more than 65°C above the ambient temperature.

The WSLP3921L3000FEA shunt from Vishay allows accurate current measurement with minimal power loss, ensuring safe fuse shut-

Figure 1: Vishay's SQJQ160E compact MOSFETs enable efficient operation of the smart eFuse due to their extremely low drain-source ON resistance.





Figure 2: Allows safe shutdown of the smart eFuse with accurate current measurement and minimal power loss: the WSLP3921L3000FEA shunt from Vishay.



Figure 3: Vishay's AEC-Q 200 certified NTC thermistor NTCS0805E3103JMT is used to monitor the board's temperature.

down. Its AEC-Q200 certification and 1% accuracy at  $0.0003 \Omega$  resistance make WSLP3921L3000FEA ideal for safety-related applications.

Temperature monitoring of the board also contributes to an increased level of safety. It is implemented with Vishay's NTC thermistor NTCS0805E3103JMT. It, too, is AEC-Q200 certified and has  $10 \text{ k}\Omega$  resistance with a deviation tolerance of 5%.

The components are located on a double-sided FR4 (flame-retardant) board measuring  $125 \text{ mm} \times 60 \text{ mm}$  in size. The smart eFuse can be controlled both via control elements on the board and via an external microcontroller or mechanical switch. The board's power consumption is  $53 \text{ mA}$  when the eFuse is disabled and  $95 \text{ mA}$  when it is conductive.

With these features, the smart eFuse from Vishay enables modern circuitry concepts and thus paves the way for the development of future-oriented vehicles. ■



## HAL<sup>®</sup> 39xy

### Stray-Field Robust 3D Position Sensors with Digital Output Interface

HAL 39xy is a Hall sensor family from TDK-Micronas addressing the need for programmable stray-field robust position sensors as well as for ISO 26262 compliant development. Product variants with integrated caps and a dual-die version are also available.

- ◆ Accurate angular measurement up to  $360^\circ$  and linear position detection
- ◆ 3D position detection
- ◆ Robust against magnetic stray-fields
- ◆ ASIL B ready
- ◆ Supply voltage:  $3.0 \text{ V}$  to  $18 \text{ V}$
- ◆ Digital output interfaces
  - SENT acc. to SAE J 2716
  - SPC
  - SPI
  - PSI5 acc. to rev. 2.2
  - 2-wire PWM
- ◆  $T_A = -40 \text{ }^\circ\text{C}$  up to  $150 \text{ }^\circ\text{C}$
- ◆ Packages: SOIC8, TO92UF, or SSOP16

Want to know more about our direct-angle sensors? Explore [www.micronas.tdk.com](http://www.micronas.tdk.com) for more details.



Automotive-qualified MEMS microphone

# The car is all ears

*Cars are learning to listen – not only in the passenger compartment but also in their external environment. Since acoustic signals from the vehicle environment can provide key information about other road users, thereby enhancing the ever-increasing driver assistance systems and automated driving features.*

BY RALF HICKL, PRODUCT SALES MANAGER AUTOMOTIVE BUSINESS UNIT (ABU)  
AT RUTRONIK

**M**icrophones have become the norm in vehicle interiors; all newer vehicles are equipped with at least the mandatory eCall system for audio communication in the event of an emergency. New applications are now being added, such as:

- Active noise cancellation (ANC) by producing a counter sound wave
- Recording of the road condition
- Spectrum analysis of engine/driving noise for preventive maintenance as well as condition and fault detection
- Detection of emergency vehicles with their siren turned on, including direction recognition

Infineon's AEC-Q103-qualified IM68A130A MEMS (microelectromechanical system) microphone is all ears when it comes to helping: It provides an analog output signal and features an integrated low-noise preamplifier (Fig. 1). As a result, it achieves a low noise floor of only  $-106$  dBV(A) and a high signal-to-noise ratio of  $68$  dB(A). At the same time, the limit for the acoustic overload point is at  $130$  dB SPL (sound pressure level). These performance characteristics contribute to a wide dynamic range for acoustic signals and provide intelligibility and signal fidelity for both very quiet or distant sounds and very loud or close sounds.

Together with a straight frequency response of between  $10$  Hz and  $16$  kHz, IM68A130A features excellent recording quality.

For voice recognition algorithms, the MEMS microphone provides processable data thanks to its high signal-to-noise ratio. Thus, even quietly spoken commands result in a good signal. When used outside the vehicle, the high



Image: Gmman/stock.adobe.com



Figure 1: The IM68A130A MEMS microphone in the TLGA package.

signal-to-noise ratio favors picking up sound from a distance, for example approaching emergency vehicles with their sirens turned on.

*Multiple microphones for more options*

Using multiple microphones at the same time opens up further options. Since in a microphone array, the sound from one source arrives at the individual microphones with varying intensities and time offsets. The direction of the sound source can be inferred from the difference in the signals. Digital signal processing can then be used to set a desired directional characteristic from the microphone array signals (beamforming). Thanks to its narrow tolerances for sensitivity and phase response, IM68A130A is also ideally suited for use in arrays.

*Faster time to market with the A<sup>2</sup>B evaluation kit*

When it comes to testing and optimizing such an array with multiple automotive-qualified MEMS microphones, Infineon's A<sup>2</sup>B evaluation kit is the ideal choice. It contains all the components required for a multi-microphone system networked via A<sup>2</sup>B bus (Fig. 2). Each slave module accommodates four microphones. The packages of the slave modules are magnetic and adhere to the sheet metal of the vehicle body (Fig. 3). A 32-bit Aurix series microcontroller in the master unit is responsible for digital signal processing. Sample software for various configurations (different number of slaves or active microphones in a slave) is also included in the evaluation kit.

Target applications for the A<sup>2</sup>B evaluation kit contain siren detection, hands-free or voice

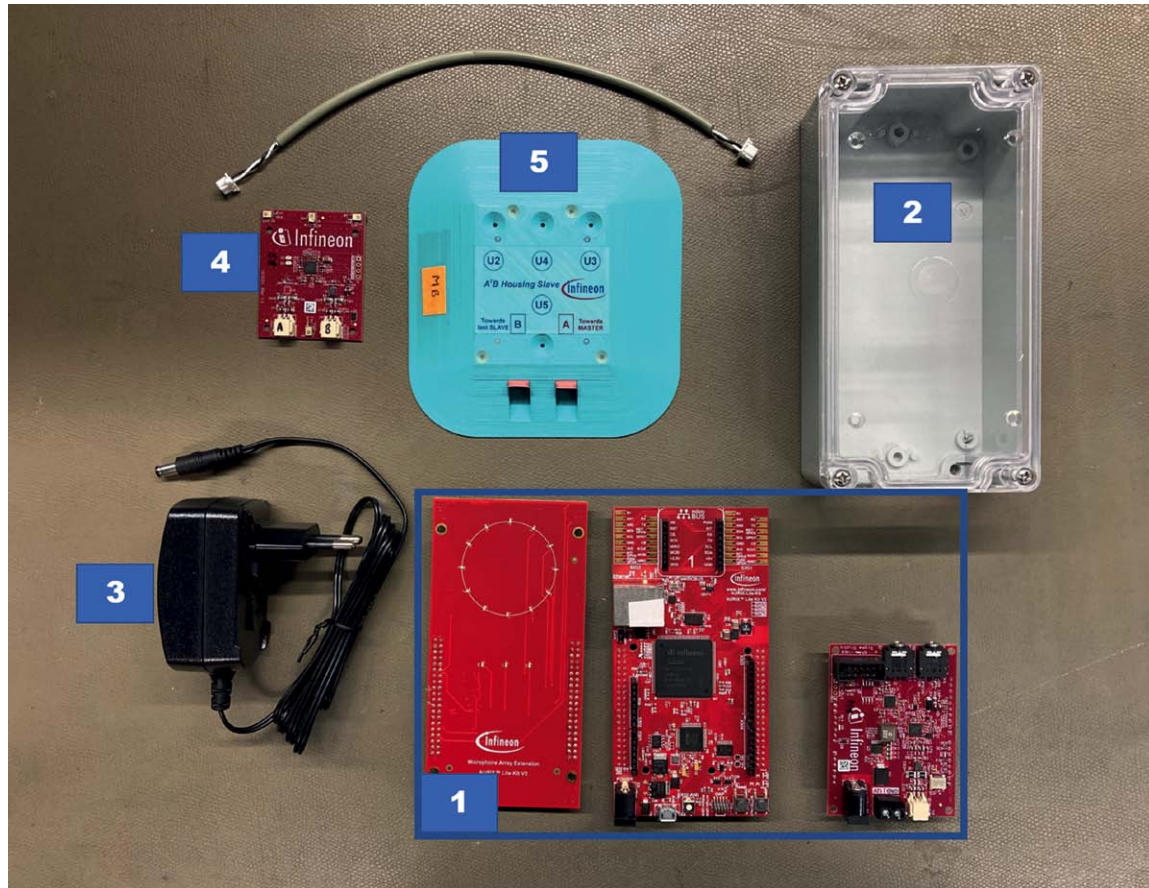

Figure 2: The A<sup>2</sup>B evaluation kit from Infineon and its components: (1) ECU master unit with microcontroller from the Aurix series, (2) package, (3) 12 V plug-in power supply, (4) one of up to four slave modules, (5) magnetic package for a slave module.

control, as well as beamforming and active noise cancellation.

*Summary*

The more human – and other – senses the vehicle adopts, the greater the advances in the automation of driving. Infineon's high-performance analog xenon MEMS microphones, e.g. IM68A130A, can ensure a sense of hearing for

acoustic environment detection. Rutronik's portfolio additionally includes further sensors for automotive use that pave the way for autonomous driving.

**ECU Master Unit:**

- Inside the car
- AURIX microcontroller
- A<sup>2</sup>B transceiver
- Power supply

**Slave modules (1-4 pcs):**

- Attached to outside of car
- 1-4 MEMS microphones
- A<sup>2</sup>B transceiver

**A<sup>2</sup>B connection:**

- Flexible cable length up to 15m between nodes

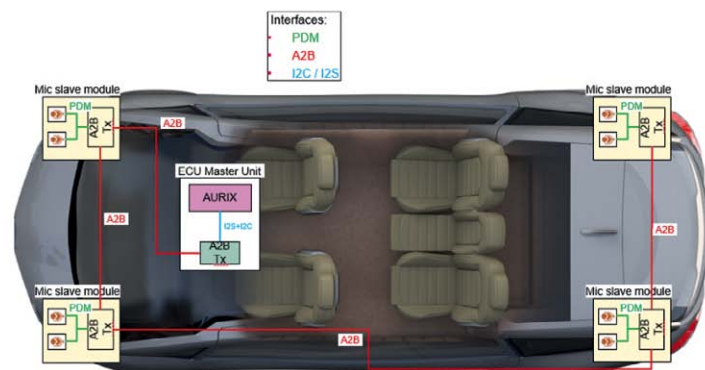

> 1, 2 or 4 microphones could be used per corner module, depending on the algorithm needs

Figure 3: Example of the distribution of four slave modules on the vehicle's exterior.

Electronic load protection with the Infineon PROFET Load Guard

# Guardians of automated mobility

*Becoming increasingly important in the future: intelligent power distribution in vehicle electrical systems. This is now much easier thanks to new components from Infineon. PROFET Load Guard is the latest family member of protected high-side switches with functions specifically designed to protect electronic loads and distribution architectures.*

BY RALF HICKL, PRODUCT SALES MANAGER AUTOMOTIVE BUSINESS UNIT (ABU) AT RUTRONIK

The trend toward advanced driver assistance systems (ADAS) and automated driving requires an intelligent and safe supply of the constantly growing number of control units. This demands the protection of the electrical system from defective consumers that cause overcurrent or even short circuits.

This protection can be provided in several ways: On the one hand, by taking measures to limit the current of individual consumers, and, on the other hand, by quickly disconnecting defective power consumers or faulty electrical system sections from the rest of the system before prolonged voltage drops occur in the electrical system. Prolonged voltage drops can otherwise force ECUs for vital ADAS functions into an undervoltage reset, temporarily disabling safety-relevant functions.

Conventional fuses and relays are unsuitable for this task as their switching speed is 100 times lower than that of intelligent semiconductor modules. This puts sensitive loads and power supplies at risk of overload. Further, melted fuses must be replaced and cannot be reset like semiconductor modules. This is not an option, especially in future zone architectures.

## New functionalities

Infineon's new PROFET Load Guard family offers an excellent combination of protection and diagnostic functionalities for designing future ADAS systems. The flexible high-side power switch covers various functions, such as power supply protection, load control and protection, self-protection, and wire protection. Since the PROFET Load Guards limit the inrush surges, they are also suitable for switching capacitive loads. Capacitive load switching mode (CLS mode) also allows large capacitors to be switched on quickly without thermally overloading the module. Due to the adjustable current limitation, the component also protects sensitive filter components in the supply line of sensors (keyword: power over coax). The close tolerance ratio ( $k_{ILIS}$ ) of the actual current value also allows precise diagnosis of the load conditions.

Fig. 1 shows an example application: Two ADAS ECUs (in this case for cameras) are supplied via power over coax. The signal (in the figure: data) and the voltage supply are separated by filters. If a camera causes a short circuit, the PROFET Load Guard (blue in the fig-

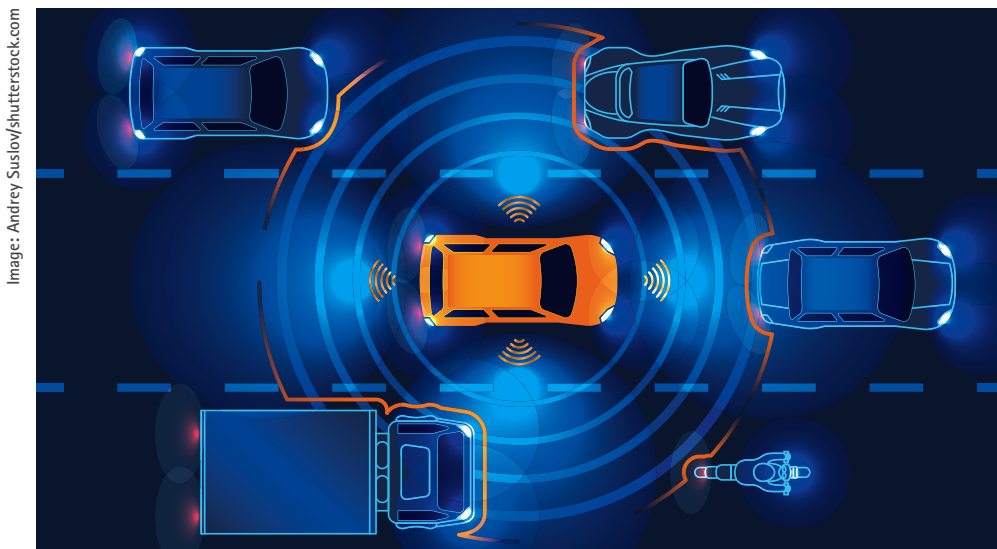

Image: Andrey Suslov/shutterstock.com



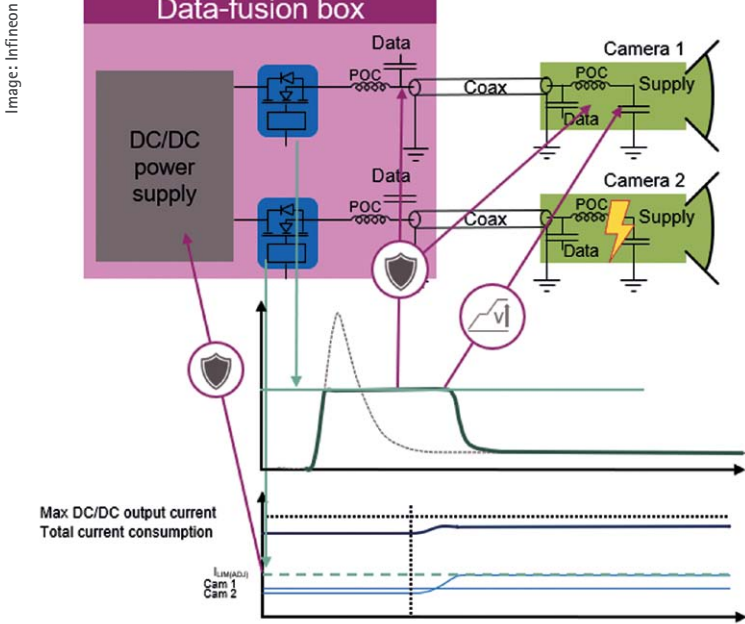

Figure 1: Use case for PROFET Load Guard 12V: power over coax for ADAS cameras.

ure) limits the load current to a preset value. On the one hand, this current limitation protects the filter coils (PoC) from overheating on the load side. On the other hand, the DC/DC power supply also remains within the specified load range and can continue to supply the other camera without any problems. The current limitation thus ensures freedom from interference between the load circuits.

*Latest development with adjustable current limitation*

Fig. 2 shows the block diagram of the BTG7090-2EPL member of the PROFET Load Guard family with its internal function blocks. The overcurrent limitation block is new. Compared to its predecessors, the PROFET Load Guard does not simply switch off in the event of overcurrent but continues to operate and limits the output current to a preset limit.

To do so, it is equipped with adjustable current limitation. An external resistor is used to configure the maximum current. In the event of an overload, the output current is limited to the limit current programmed with the resistor, and the output transistor of the PROFET Load Guard goes into linear operation. The resulting power loss in the transistor heats up the component. The component only switches off the affected channel to protect itself when the chip temperature or the temperature gradient reaches a certain maximum value. Then the retry strategy comes into play, a combination of auto-restart and latch-off: After switching off, the chip temperature drops

# Apacer

## Industrial SSD & DRAM Solutions for Healthcare Applications

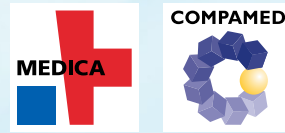

**DÜSSELDORF, GERMANY**  
**14-17 NOVEMBER 2022**

Visit us at  
**Hall 8a/E15**



Apacer Technology B.V.  
[sales@apacer.nl](mailto:sales@apacer.nl)

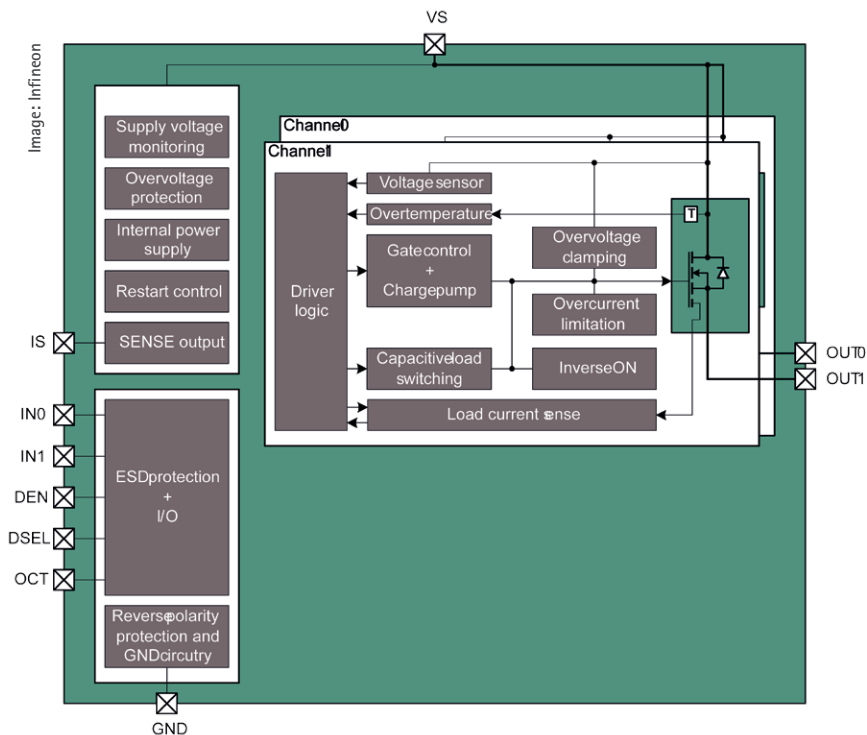

Figure 2: Block diagram of PROFET Load Guard BTG7090-2EPL.

again and the PROFET Load Guard is switched back on automatically (assuming a continuous high signal at the control input). After six unsuccessful restart attempts, the output stage switches off permanently (latch-off). A low-high sequence at the control input resets the internal retry counter and switches the output back on.

Due to the adjustable current limitation, the module offers high flexibility in the application, as the functionality can be adapted to changing requirements through the choice of the resistor.

For self-protection, the switch relies on its temperature monitor with switch-off due to overtemperature. Needless to say, the controlling microcontroller can also switch off the PROFET Load Guard. The diagnostic feedback signals on the sense pin are used as the basis for its decisions. The module thus also provides precise feedback ( $\pm 5\%$ ) on the current power consumption of the load.

*Dealing with return current reduces power loss*

PROFET Load Guards can only switch off the current in one direction. In the other direction, the intrinsic body diode of the MOSFET conducts even if the channel itself does not. Return current exists, for example, in regenerative motors as a load. High power losses

can occur in the body diode and heat up the chip and possibly also adjacent channels, causing them to switch off.

The InverseOn product feature allows the internal MOSFET to be switched on as long as the return current is within certain limits. The advantage: The power loss that occurs in the channel of the MOSFET is smaller than that which would occur in the body diode.

Thanks to the Capacitive Load Switching (CLS) function block, the PROFET Load Guard is also suitable for fast charging and switching on large capacitive loads. For this purpose, the input is controlled with specific PWM. This PWM signal puts the module into CLS mode with the continuous auto-restart switch-off strategy. The switching cycles "Switch on and supply with limit current" and "Switch off due to protection against steep temperature rise" are repeated until the voltage drop at the output transistor, in ON state, falls below a cer-

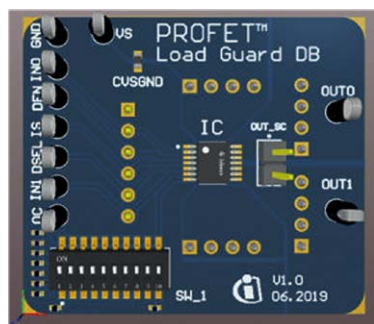

Figure 4: Daughterboard with PROFET Load Guard.

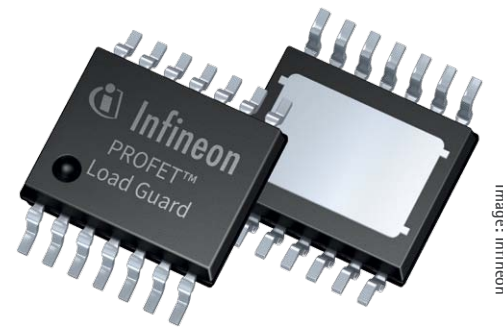

Figure 3: PROFET Load Guard with two channels in the TSDSO package with 14 pins.

tain value. In this case, the capacitive load is considered to be sufficiently charged. After that the PWM is permanently switched through and can be replaced by a high level at the control input. Advantage: The module remains in the specified safe operating area (SOA) during this period.

*Availability, simulation capabilities, and evaluation boards*

PROFET Load Guards are ISO-26262-ready. Infineon, therefore, provides information in a safety application note (SAN) that helps to integrate the component into a functionally safe system. The first derivative is the dual-channel BTG7090-2EPL; samples are available from Rutronik upon request. Large-scale production is set to start in late 2022. Interested parties can find the data sheet, simulation models, and other tools at [www.infineon.com/profetloadguard](http://www.infineon.com/profetloadguard).

For evaluation purposes, Infineon offers two boards for assembling a kit: the motherboard PROFET ONE4ALL MB V1 and the daughterboard BTG7090-2EPL DAUGH BRD (Fig. 4).

Together with Infineon's  $\mu$ IO-Stick and the Config Wizard GUI, the module can be configured, controlled, and tested.

*Summary*

ADAS require a reliable power supply within the vehicle electrical system. To achieve this, the electrical system must be protected from other defective consumers with excessive current requirements. With its current-limiting function that can be adapted to system requirements, the PROFET Load Guard does not allow hazardous short-circuit currents and peak currents at its outputs in the first place, thus protecting the load and the 12 V power supply against overload.

Intel® NUC 12 Pro Mini PCs, Kits, & Boards

# Small Size. Big Business Performance.



## Intel® NUC Pro form factors

Available as mini PCs or customizable kits, every device is qualified for 24x7 operation and comes with three-year availability and a three-year warranty.



### Intel® NUC 12 Pro Mini PCs

Small PCs and compact workstations, loaded with Windows and ready to use right out of the box. Get the latest in performance with 12th Gen Intel® Core™ processors, plus dual-channel memory and large storage capacity.



### Intel® NUC 12 Pro Kits

Kits include a range of 12th Gen Intel® Core™ processors, chassis, and board. They are easy to customize with the right operating system, memory, and storage to meet different customer needs.



### Intel® NUC 12 Pro Boards

Choose from Intel® NUC board, compute, and chassis elements to create unique integrated or embedded compute solutions.

## Powerful Performance. Perfect Fit.

Intel® NUC 12 Pro Mini PCs, Kits, and Boards raise the bar for performance and connectivity in a 4x4 device for productivity, collaboration, and edge compute. 12th Gen Intel® Core™ processors—plus up to 64GB dual-channel memory and massive SSD capacity—drive enterprise-class performance in a pint-sized PC. Collaboration is faster and easier than ever with lightning-fast wired and wireless connectivity options. Select SKUs come with Intel vPro® technology for remote manageability, hardware-enhanced security features, and platform stability to help businesses cut IT costs and boost uptime.

The systems are built to deliver great experiences at the edge, with their small size, numerous ports front and back, dual LAN expansion module (select SKUs), and these added features:

- Intel Watchdog Utility: Monitors and can automatically restart applications.
- Display emulation: Enables emulation of displays for one or both HDMI ports when a display is not attached or is temporarily disconnected.
- Client management interface: HDMI CEC can be queried and configured via the WMI interface.

Every Intel® NUC 12 Pro Mini PC, Kit, and Board is qualified for 24x7 operation and designed to last with a three-year warranty from Intel. For performance, connectivity, and reliability in a small footprint, these 4x4s are tough to beat.

### Features

- 12th Gen Intel® Core™ i7/i5/i3 processors
- Intel vPro® Enterprise with 12th Gen Intel® Core™ i7/i5 processors
- Up to 64GB dual-channel DDR4-3200 memory
- Intel® Iris® Xe graphics or Intel® UHD graphics
- M.2 slots for PCIe x4 Gen 4 NVMe SSD and second SSD (select SKUs support third SSD)
- 2x Thunderbolt™ 4 ports (select SKUs),
- 3x USB 3.2 ports, 1 USB 2.0 port,
- 2x HDMI 2.1 TMDS Compatible
- Intel® i225-V Ethernet for speeds up to 2.5 Gbps and Intel® Wi-Fi 6E AX211 (Gig+)
- Tall SKU available with second Ethernet port (Intel® i225-V) and two additional USB 2.0 ports
- Tolerates 0–40° C external ambient operating temperature
- All USB ports with individual USB power control
- Intel three-year warranty
- Three-year product availability

#### Productivity

Including business computing and home office

#### Collaboration

Including video conferencing and huddle rooms

#### Edge compute

Including digital signage, digital kiosks, intelligent vending, and edge appliances

Connect up to  
**one 8K or four 4K  
displays**

Qualified for  
**24/7 operation**

Intel® NUC 12 Pro: **Go Small for Big Performance**



# ModusToolbox™

ModusToolbox™ software is a modern, extensible development environment supporting a wide range of Infineon microcontroller devices. Provided as collection of development tools, libraries, and embedded runtime assets architected to provide a flexible and comprehensive development experience.

## Development workflow

ModusToolbox™ provides an adaptable work environment with options for various IDEs, command-line tools with GUI options, and a make-based build system.

## Middleware management

The middleware libraries within the ModusToolbox™ Library Manager, can be imported directly into your project structure and seamlessly incorporated into the build environment.

## Functional API levels

ModusToolbox™ includes peripheral drivers and functional APIs including a HAL for maximizing portability, and a Peripheral Driver Library for maximizing code efficiency and device capabilities.

## Application portability

Application portability is facilitated through the availability of HAL APIs, code generators, and Board Support Packages.

Develop the way you want to develop, with the workflow you get to define.



[www.infineon.com/modustoolbox](http://www.infineon.com/modustoolbox)

