

AC Filter, High Symmetrical Attenuation

new



Protection class II Case UL



Bolt and nut M4 Case PK



Wire leads Case PI

See below:  
[Approvals and Compliances](#)

**Description**

- 1-stage-line-filter with high attenuation
- Version with ground line choke
- Protection class II variants
- 4 designs
  - N) excellent symmetrical noise attenuation
  - P) high symmetrical noise attenuation
  - Q) standard symmetrical noise attenuation
  - HP) high performance

**Unique Selling Proposition**

- Excellent symmetrical attenuation
- Compact and cost optimized
- Completely closed steel housing
- Optional wire leads

**Characteristics**

- Compact filter with high symmetrical attenuation
- Designed for universal industrial applications
- Especially designed for applications with symmetrical noise caused by switching semiconductors
- Suitable for use in equipment according to IEC/UL 62368-1
- Suitable for use in medical equipment according to IEC/UL 60601-1 (1 MOOP, 1 MOPP), (Protection class II: 2 MOOP, 2 MOPP)

**Other versions on request**

- Version with wire connection
- Version with varistor for overvoltage protection

**Weblinks**

[pdf data sheet](#), [html datasheet](#), [General Product Information](#), [Approvals](#), [Distributor-Stock-Check](#), [Detailed request for product](#), [Microsite](#)

**Technical Data**

Ratings IEC	1 - 60A @ Ta 40 °C / 250 VAC; 50Hz
Ratings UL/CSA	1 - 60A @ Ta 40 °C / 125/250VAC; 60Hz
Leakage Current	industrial < 1 mA (250V / 60Hz) standard < 0.5 mA (250 V / 60 Hz) medical (M5) < 5 µA (250 V / 60 Hz) medical (M80) < 80 µA (250 V / 60 Hz)
Dielectric Strength	> 1.7 kVDC between L-N > 2.7 kVDC between L/N-PE Protection class II: >5.6kVDC between L/N-metal housing Test voltage (2 sec)
Allowable Operation Temperature	-40 °C to 100 °C
Climatic Category	40/100/21 acc. to IEC 60068-1
Protection Class	Suitable for appliances with protection class I or II acc. to IEC 61140
Terminal	Quick connect terminal 6.3 x 0.8 mm Bolt and nut
Material	Nickel plated steel

Surge protection	320 VAC 420 VDC 67 J
Line Filter	Standard, medical and industrial version, IEC 60939, UL 1283, CSA C22.2 no. 8 <a href="#">Technical Details</a>
MTBF	> 200'000h acc. to MIL-HB-217 F

**Approvals and Compliances**



Detailed information on product approvals, code requirements, usage instructions and detailed test conditions can be looked up in [Details about Approvals](#)

SCHURTER products are designed for use in industrial environments. They have approvals from independent testing bodies according to national and international standards. Products with specific characteristics and requirements such as required in the automotive sector according to IATF 16949, medical technology according to ISO 13485 or in the aerospace industry can be offered exclusively with customer-specific, individual agreements by SCHURTER.

**Approvals**



The approval mark is used by the testing authorities to certify compliance with the safety requirements placed on electronic products.

Approval Reference Type: FMAB NEO

Approval Logo	Certificates	Certification Body	Description
	<a href="#">VDE Approvals</a>	VDE	Certificate Number: 40041643
	<a href="#">UL Approvals</a>	UL	UR File Number: E72928

**Product standards**

Product standards that are referenced

Organization	Design	Standard	Description
	Designed according to	IEC 60939	Passive filters for suppressing electromagnetic interference
	Designed according to	UL 1283	Electromagnetic interference filters
	Designed according to	CSA C22.2 no. 8	Electromagnetic interference (EMI) filters





**Application standards**

Application standards where the product can be used

Organization	Design	Standard	Description
	Suitable for applications acc.	IEC/UL 62368-1	Audio/video, information and communication technology equipment - Part 1: Safety requirements

**Compliances**

The product complies with following Guide Lines

Identification	Details	Initiator	Description
	<a href="#">CE declaration of conformity</a>	SCHURTER AG	The CE marking declares that the product complies with the applicable requirements laid down in the harmonisation of Community legislation on its affixing in accordance with EU Regulation 765/2008.
	<a href="#">UKCA declaration of conformity</a>	SCHURTER AG	The UKCA marking declares that the product complies with the applicable requirements laid down in the British Amendment of Regulation (EC) 765/2008.
	RoHS	SCHURTER AG	Directive RoHS 2011/65/EU, Amendment (EU) 2015/863
	China RoHS	SCHURTER AG	The law SJ / T 11363-2006 (China RoHS) has been in force since 1 March 2007. It is similar to the EU directive RoHS.
	REACH	SCHURTER AG	On 1 June 2007, Regulation (EC) No 1907/2006 on the Registration, Evaluation, Authorization and Restriction of Chemicals 1 (abbreviated as "REACH") entered into force.

**Dimension [mm]**

Case PG with quick connect terminals

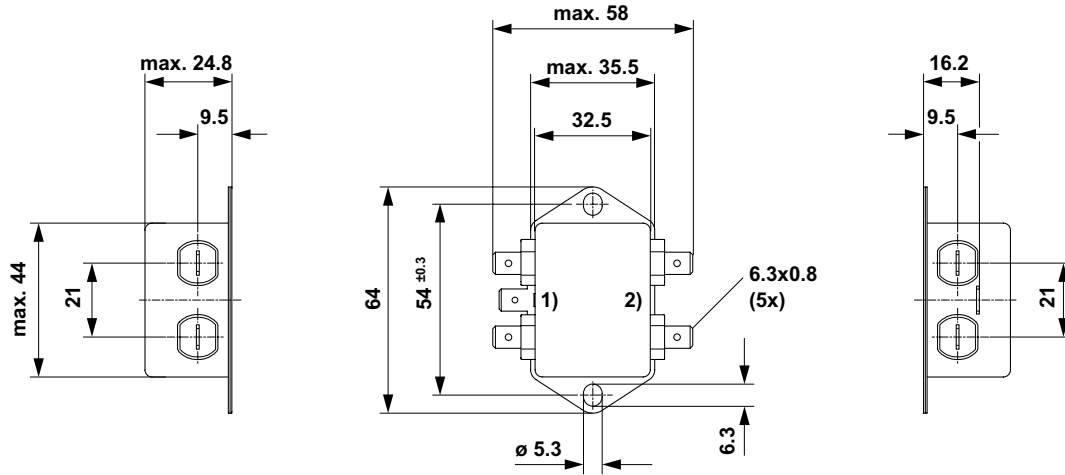

- 1) Line
- 2) Load

Case PH with quick connect terminals

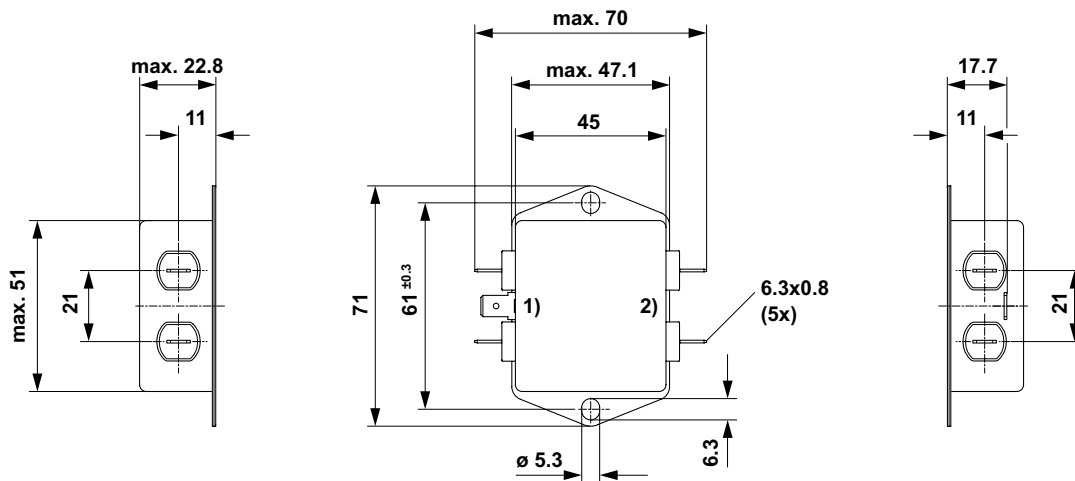

- 1) Line
- 2) Load

Case PI with quick connect terminals

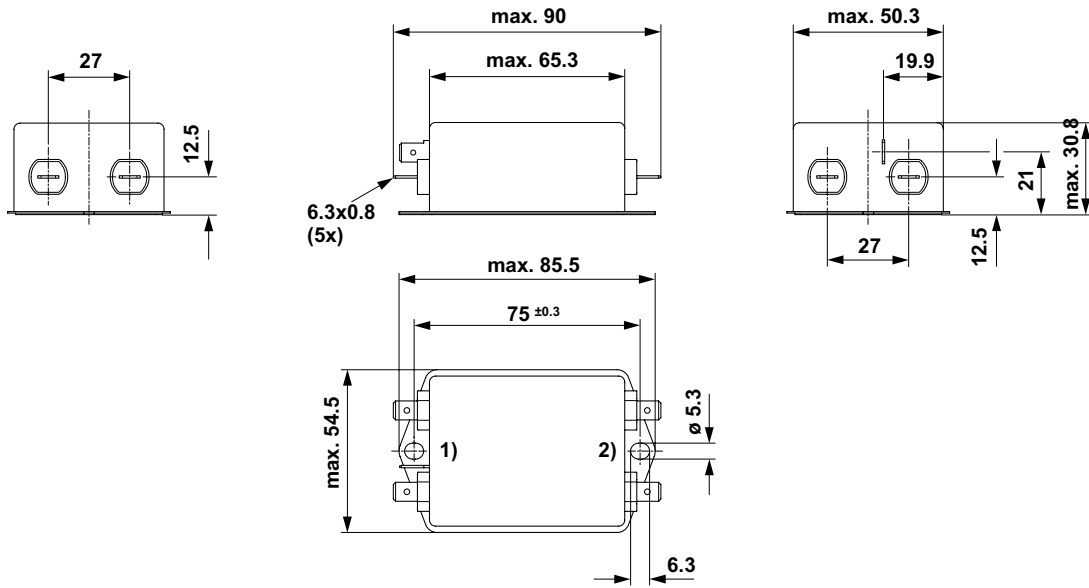

- 1) Line
- 2) Load

Case PK with quick connect terminals

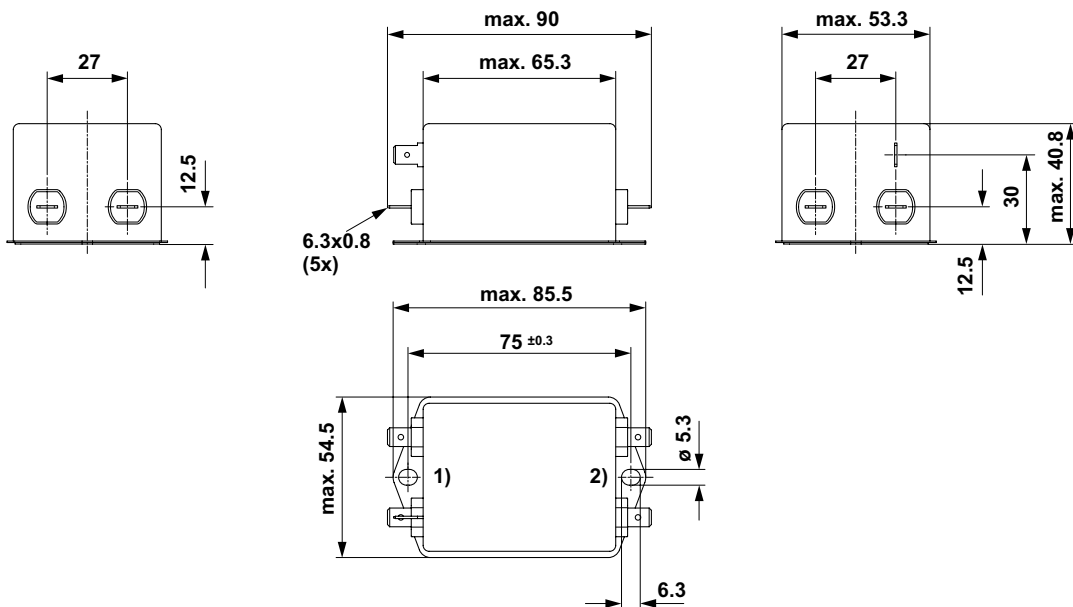

- 1) Line
- 2) Load

Case PK with bolt and nut

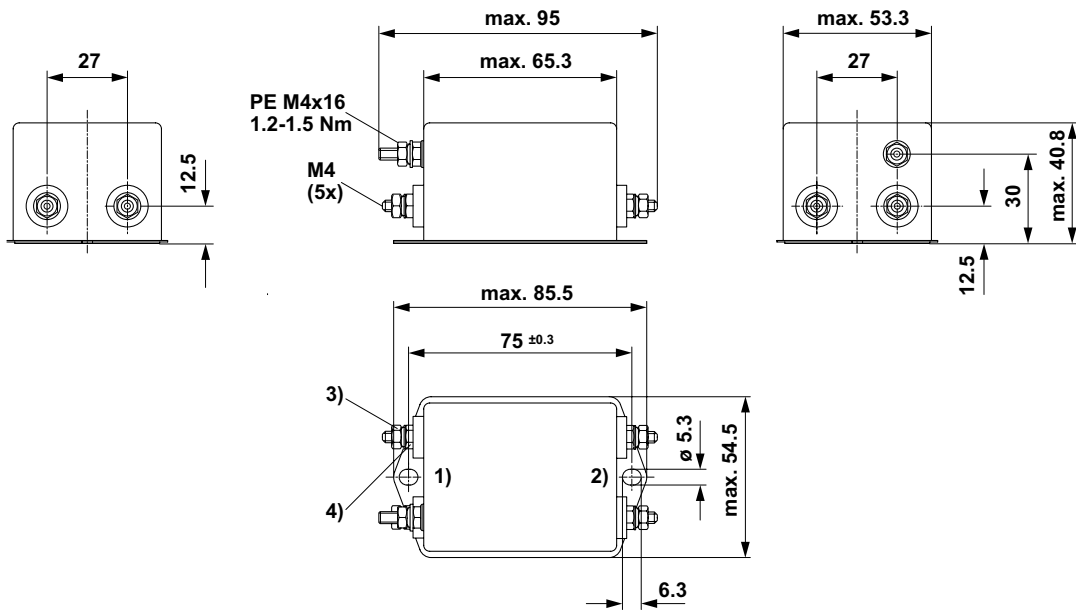

- 1) Line
- 2) Load
- 3) Nut torque 0.8...1 Nm, keep lock-nut fastened
- 4) Lock-nut do not unscrew

Case QC with quick connect terminals

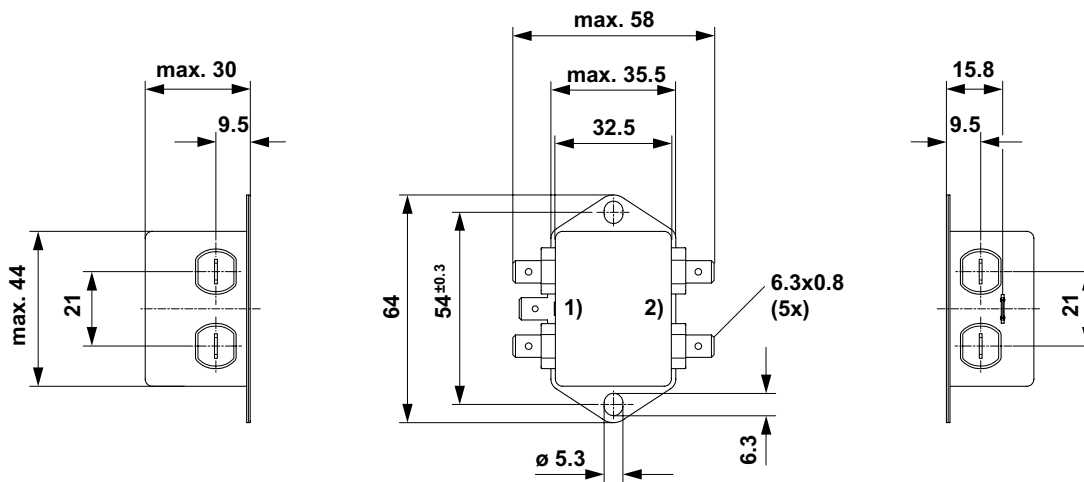

- 1) Line
- 2) Load

## Case QD with quick connect terminals

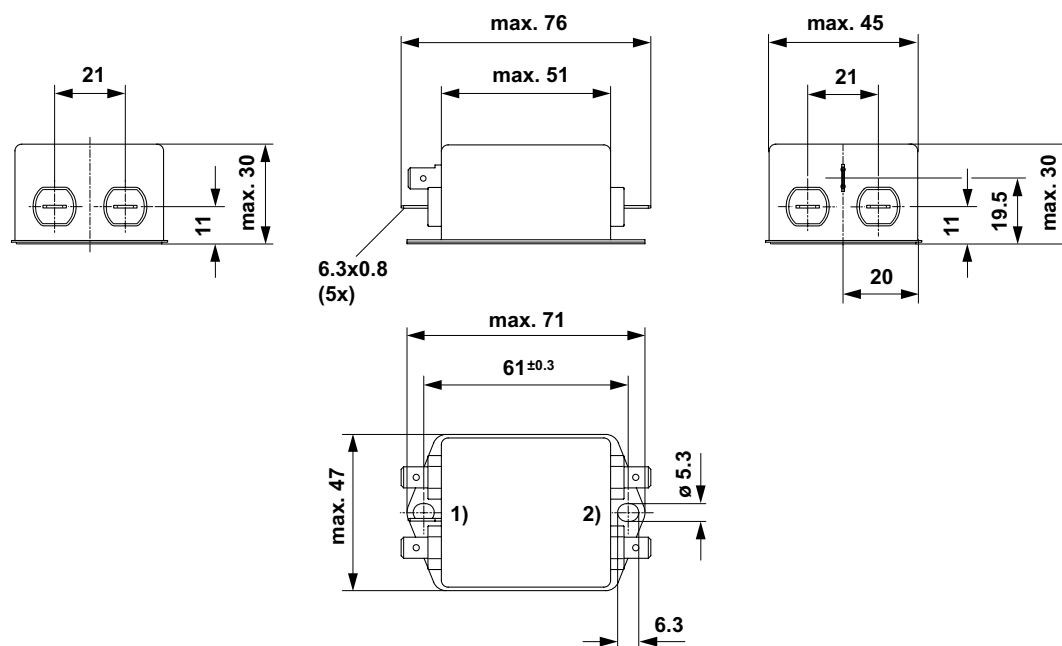

- 1) Line
- 2) Load

## Case QE with bolt and nut

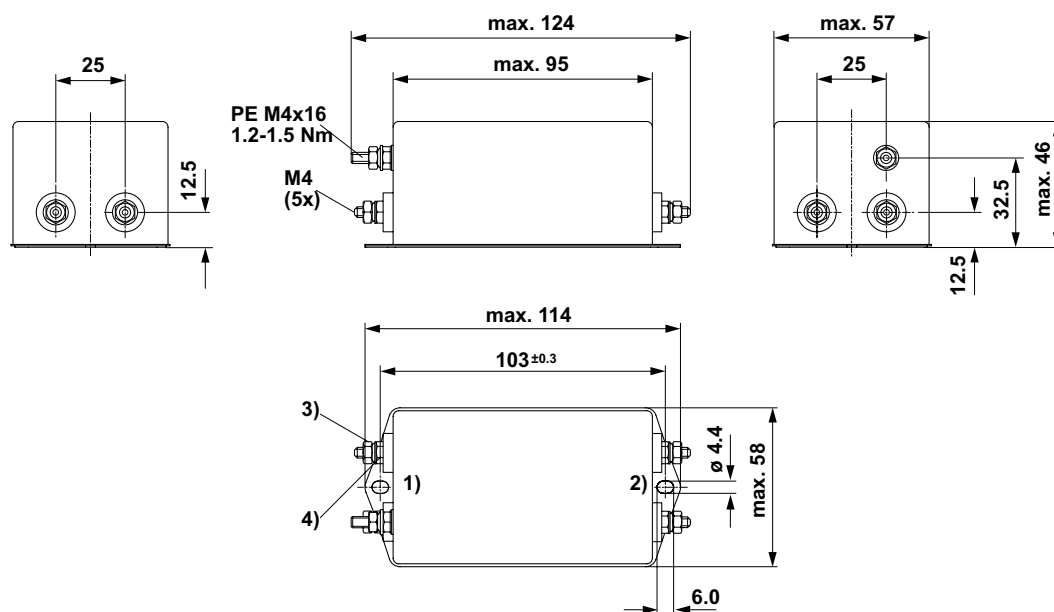

- 1) Line
- 2) Load
- 3) Nut torque 0.8...1 Nm, keep lock-nut fastened
- 4) Lock-nut do not unscrew

Case QF with bolt and nut

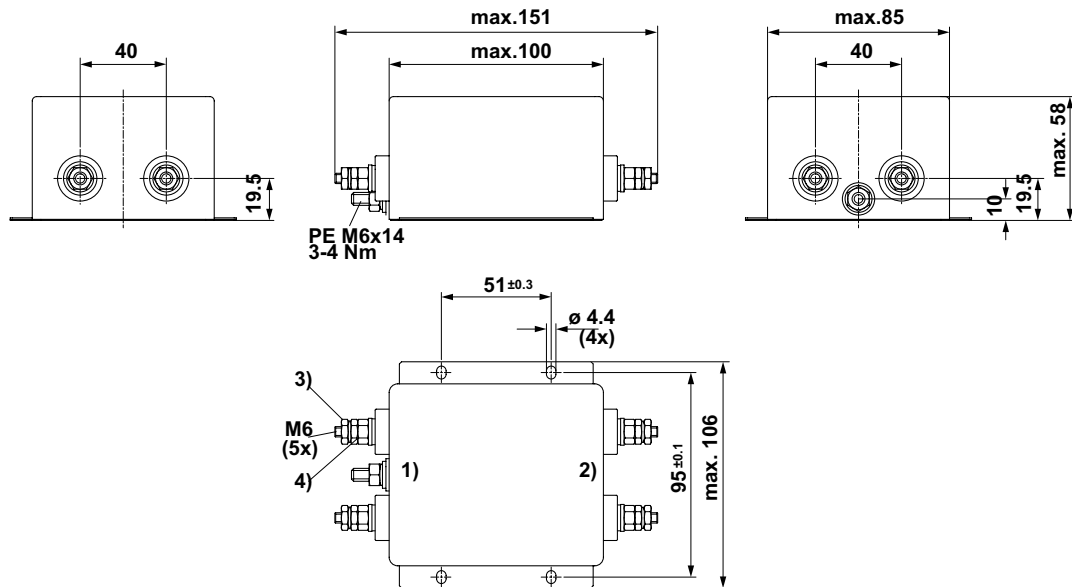

- 1) Line
- 2) Load
- 3) Nut torque 0.8...1 Nm, keep lock-nut fastened
- 4) Lock-nut do not unscrew

Case with wire leads

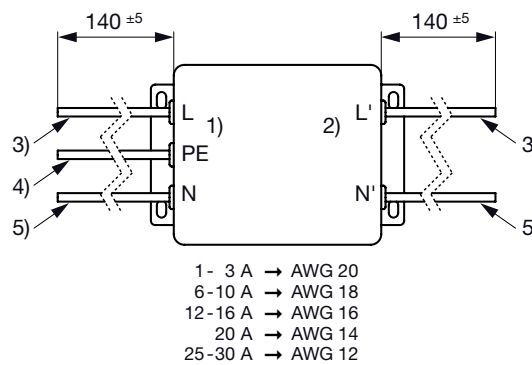

- 1) Line
- 2) Load
- 3) Brown
- 4) Yellow-Green
- 5) Blue

Case UL Protection class II

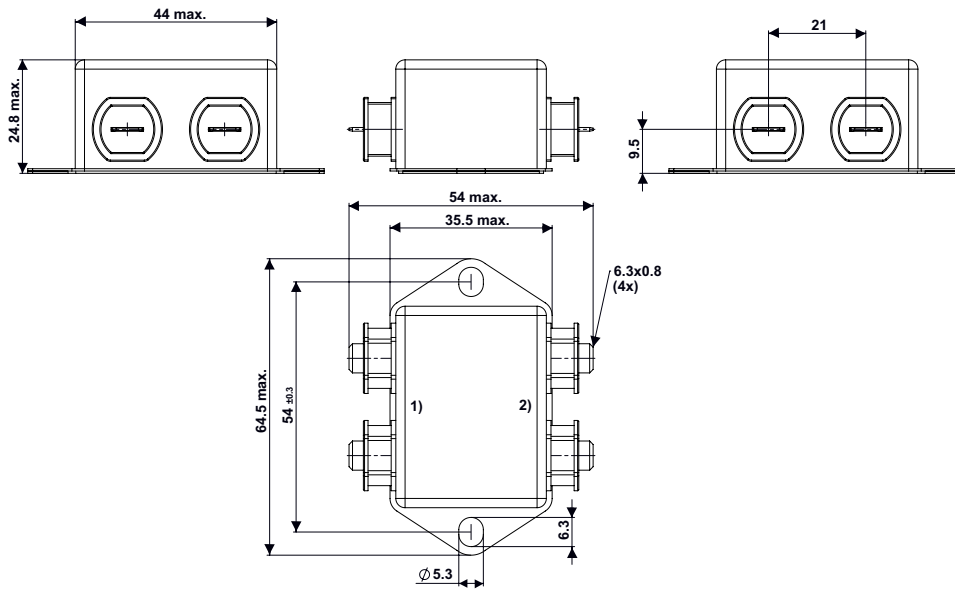

- 1) Line
- 2) Load

Case UM Protection class II

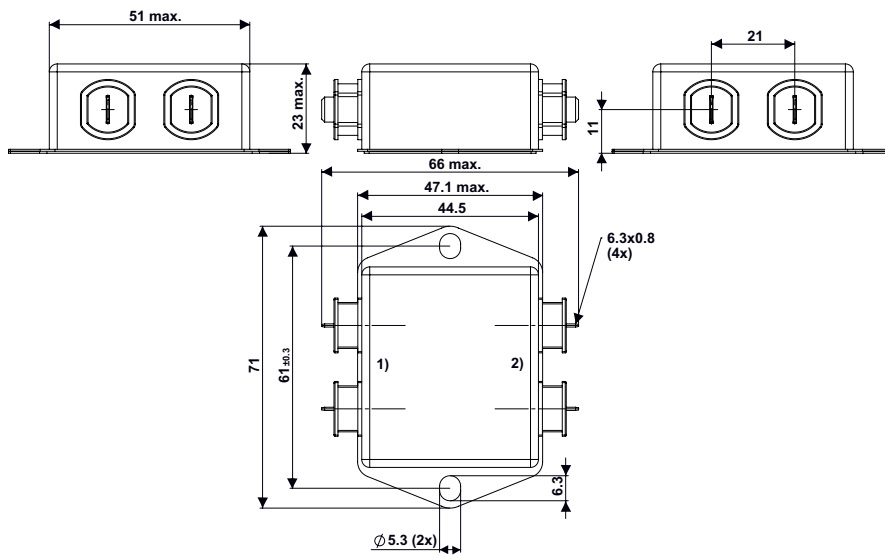

- 1) Line
- 2) Load



Case UN Protection class II

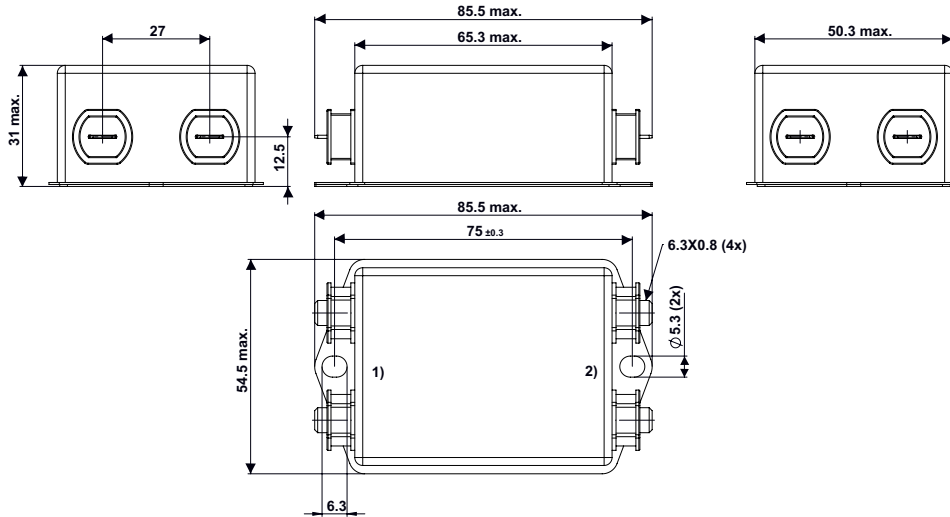

- 1) Line
- 2) Load

Case UO Protection class II

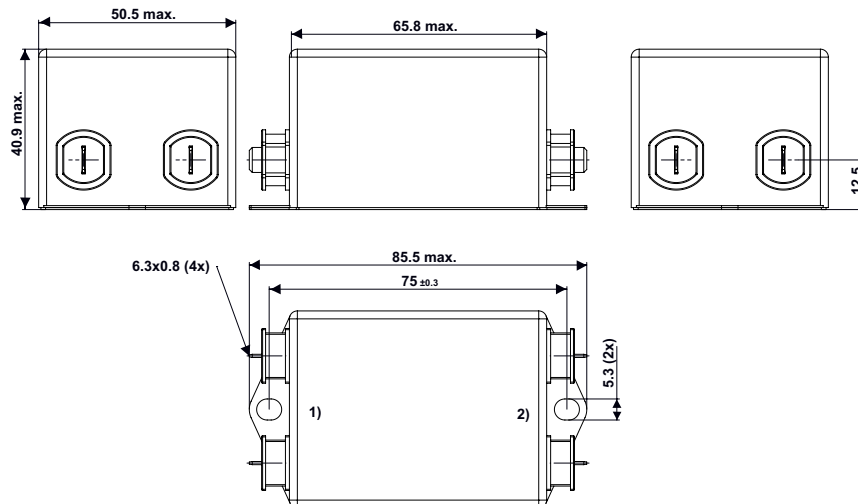

- 1) Line
- 2) Load

Case UG with Ground Line Choke

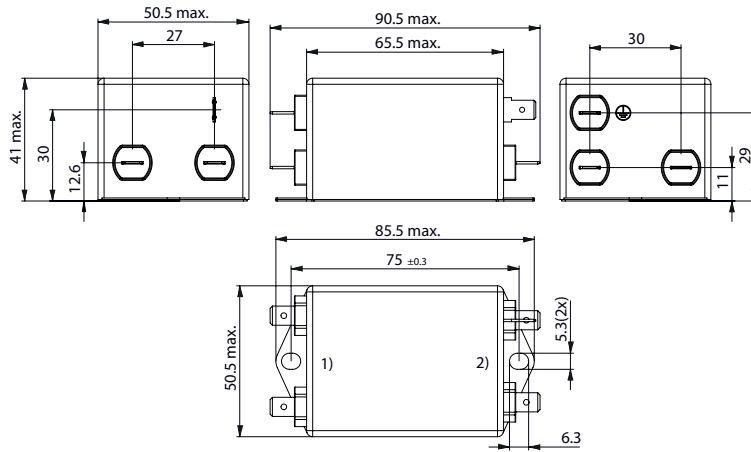

- 1) Line
- 2) Load

Case UI with Ground Line Choke

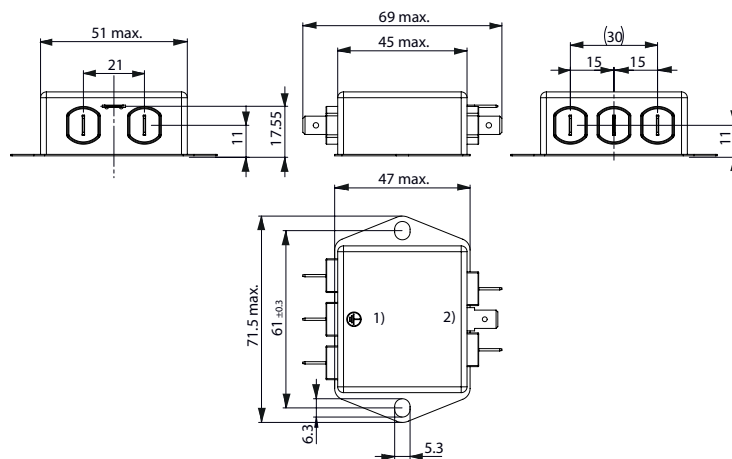

- 1) Line
- 2) Load

Diagrams

Standard Version or medical M80  
 Design N, P

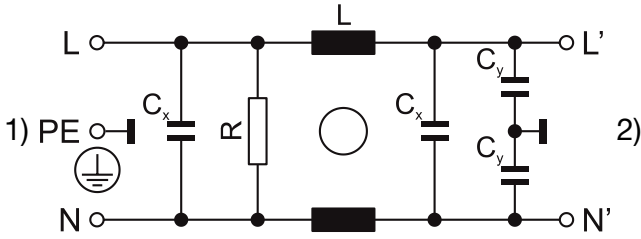

1) Line  
 2) Load

Medical Version (M5)  
 Design N, P

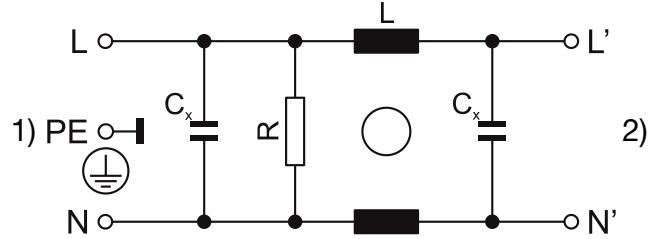

1) Line  
 2) Load

Standard Version or medical M80  
 Design Q

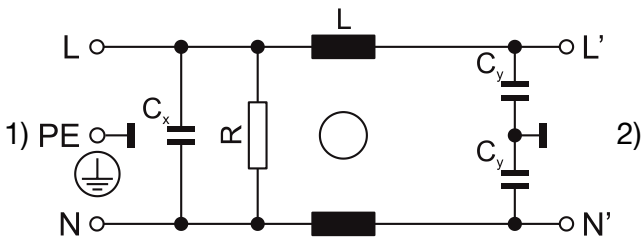

1) Line  
 2) Load

Medical Version (M5)  
 Design Q

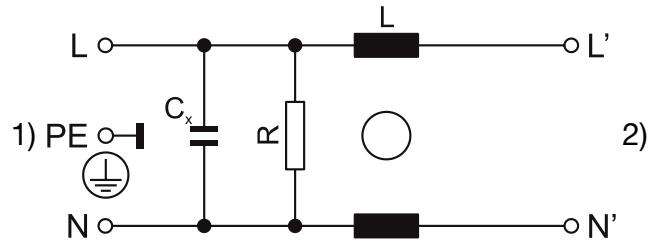

1) Line  
 2) Load

Medical Version (M5)  
 Protection class II

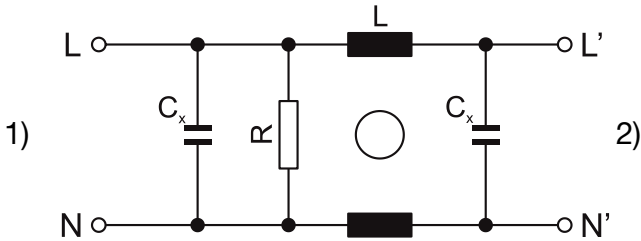

1) Line  
 2) Load

Standard or Medical Version (M80) with ground line choke  
 Design N

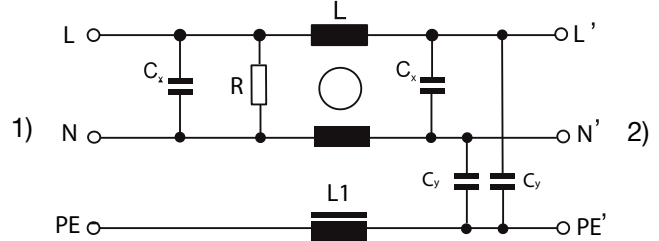

1) Line  
 2) Load

Medical Version (M5) with ground line choke  
 Design N

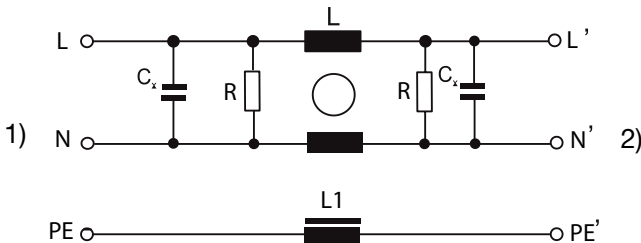

1) Line  
 2) Load

**Attenuation Loss** . . . . 0.1/100Ω differential mode ..... 100/0.1Ω differential mode - - - - 50Ω differential mode \_\_\_\_ 50Ω common mode

Standard version

1 A / Design N

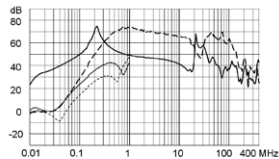

3 A / Design N

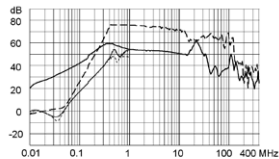

4 A / Design N

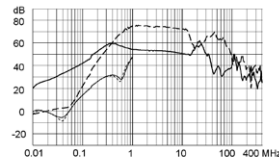

6 A / Design N

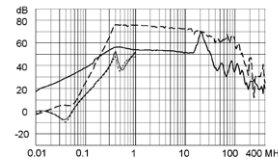

8 A / Design N

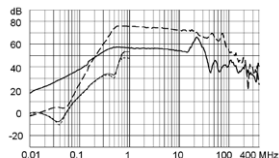

10 A / Design N

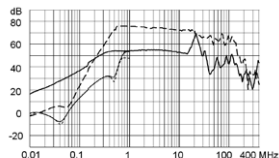

12 A / Design N

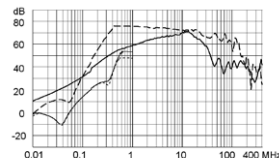

16 A / Design N

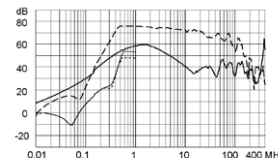

20 A / Design N

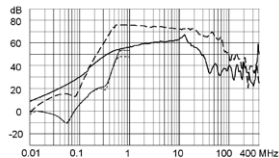

30 A / Design N

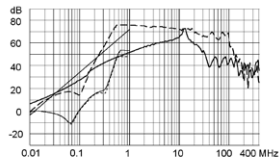

1 A / Design P

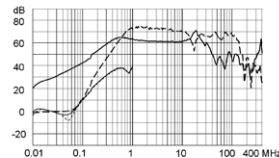

3 A / Design P

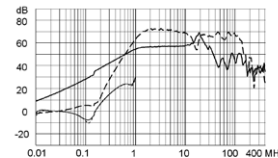

6 A / Design P

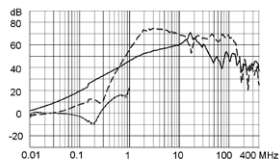

10 A / Design P

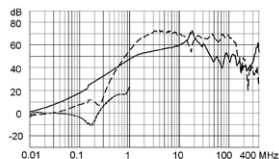

12 A / Design P

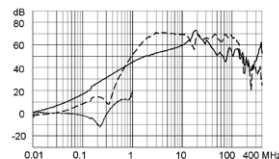

16 A / Design P

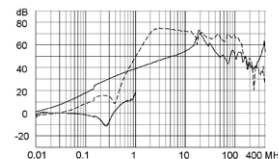

20 A / Design P

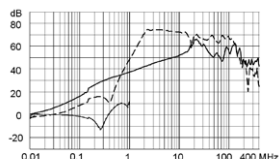

30 A / Design P

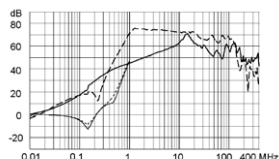

60 A / Design P

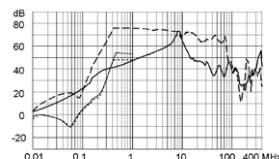

1 A / Design Q

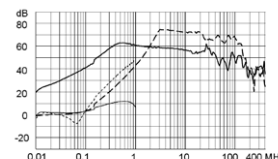

3 A / Design Q

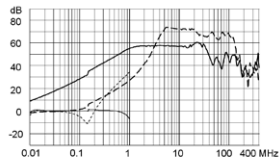

6 A / Design Q

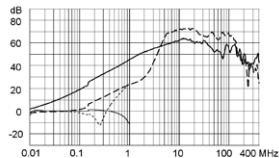

10 A / Design Q

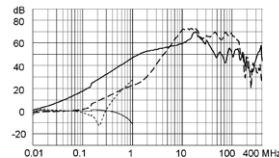

12 A / Design Q

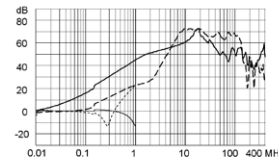

16 A / Design Q

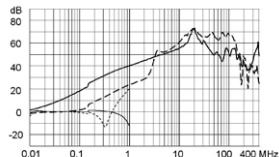

20 A / Design Q

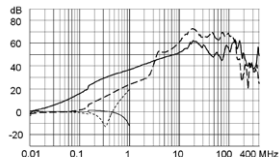

30 A / Design Q

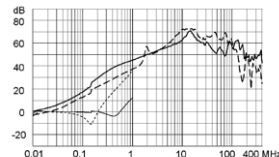

60 A / Design Q

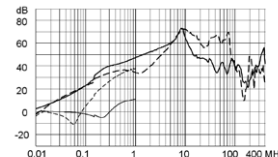



Medical version (M80)

1 A / Design N

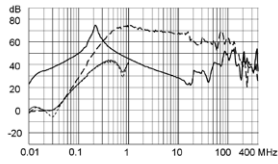

3 A / Design N

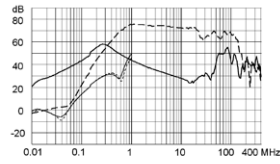

4 A / Design N

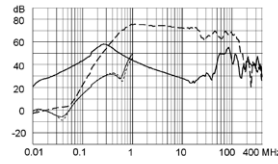

6 A / Design N

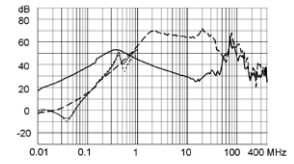

8 A / Design N

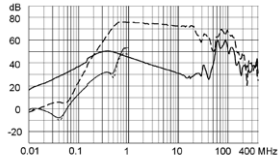

10 A / Design N

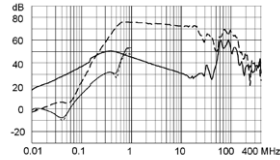

12 A / Design N

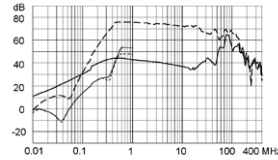

16 A / Design N

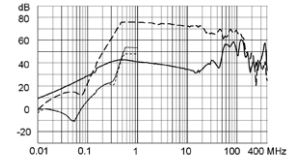

20 A / Design N

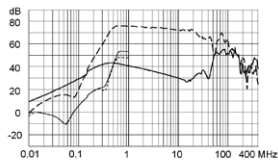

30 A / Design N

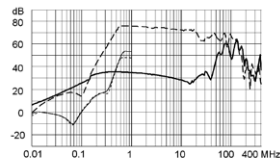

1 A / Design P

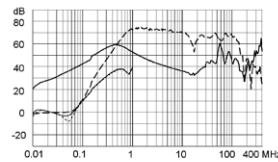

3 A / Design P

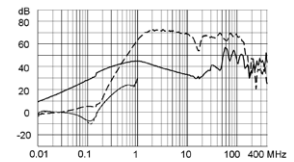

6 A / Design P

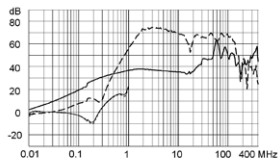

10 A / Design P

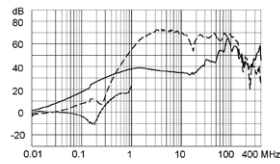

12 A / Design P

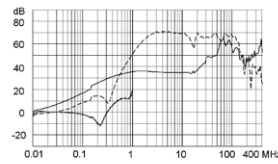

16 A / Design P

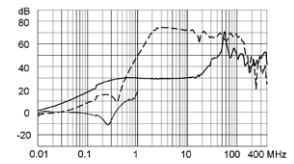

20 A / Design P

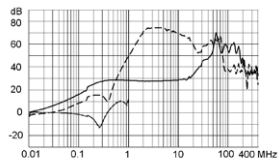

30 A / Design P

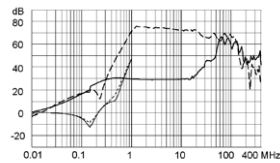

60 A / Design P

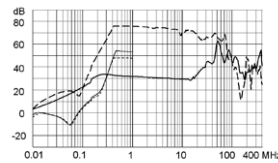

1 A / Design Q

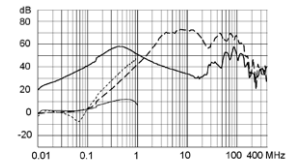

3 A / Design Q

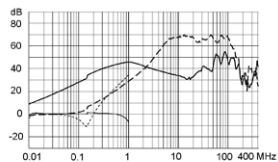

6 A / Design Q

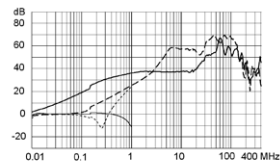

10 A / Design Q

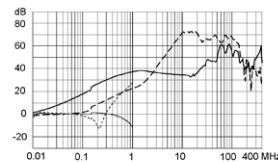

12 A / Design Q

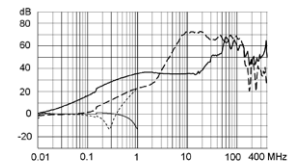

16 A / Design Q

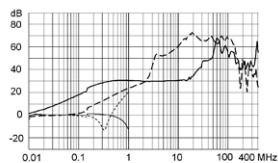

20 A / Design Q

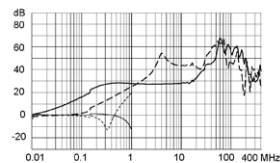

30 A / Design Q

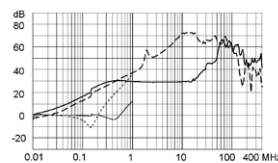

60 A / Design Q

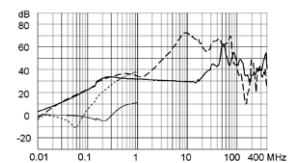

Standard with Earth Line Choke

1 A / Design N

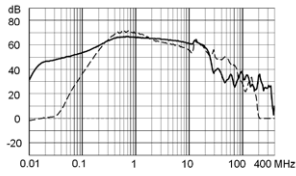

3 A / Design N

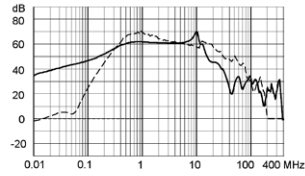

4 A / Design N

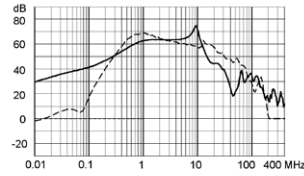

6 A / Design N

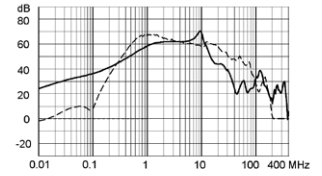

8 A / Design N

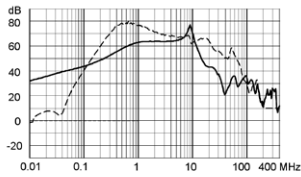

10 A / Design N

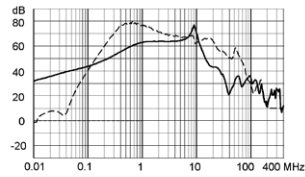

12 A / Design N

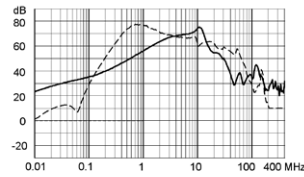

16 A / Design N

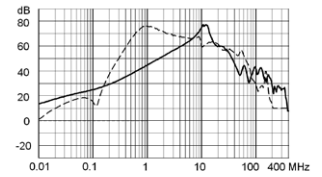

20 A / Design N

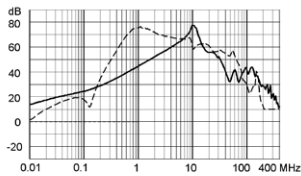

Medical (M5) with Earth Line Choke

1 A / Design N

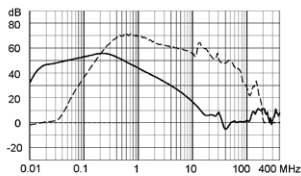

3 A / Design N

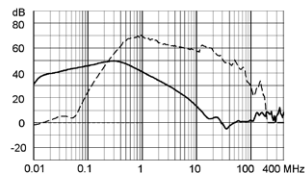

4 A / Design N

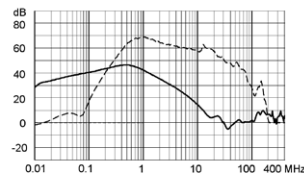

6 A / Design N

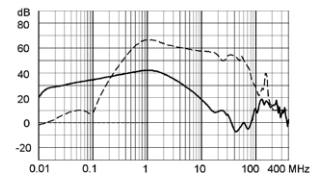

8 A / Design N

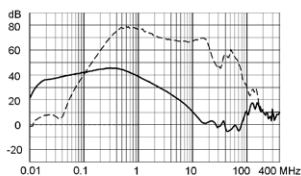

10 A / Design N

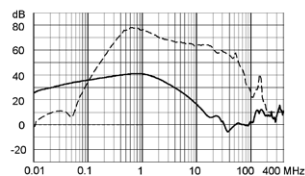

12 A / Design N

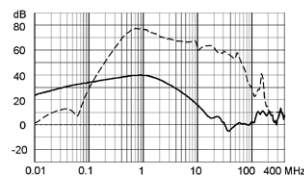

16 A / Design N

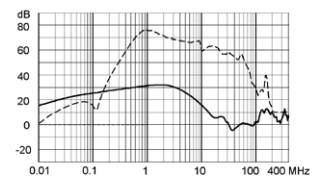

20 A / Design N

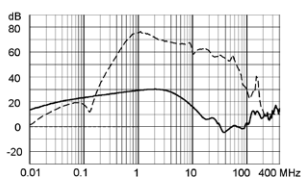

Medical (M80) with Earth Line Choke

1 A / Design N

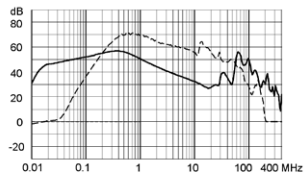

3 A / Design N

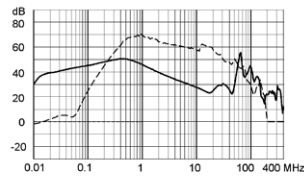

4 A / Design N

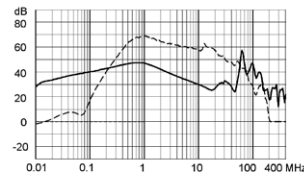

6 A / Design N

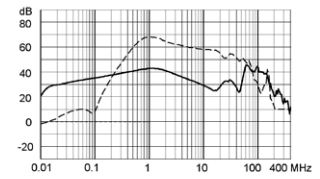

8 A / Design N

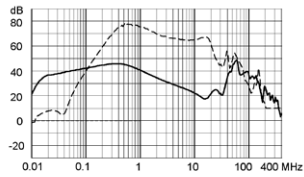

10 A / Design N

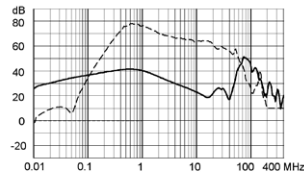

12 A / Design N

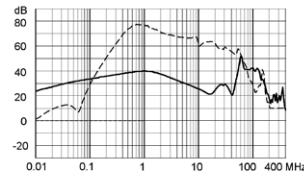

16 A / Design N

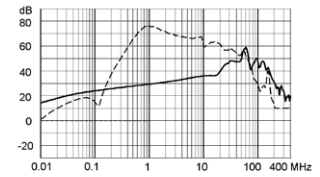

20 A / Design N

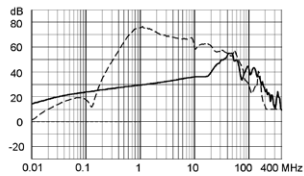

Standard HP

1 A

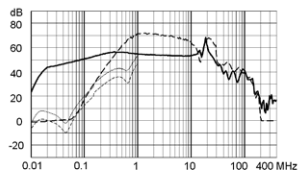

3 A

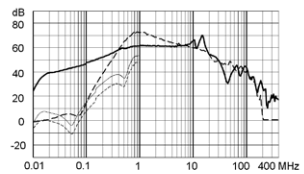

4 A

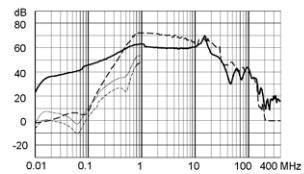

6 A

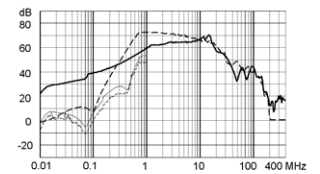

8 A

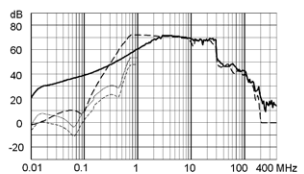

10 A

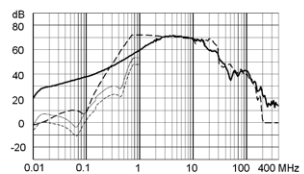

12 A

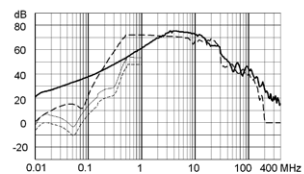

16 A

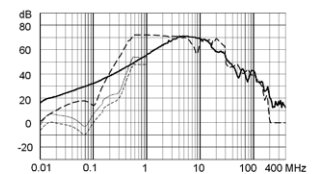

20 A

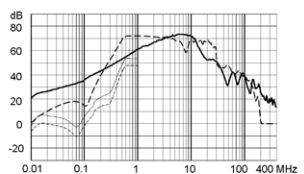

30 A

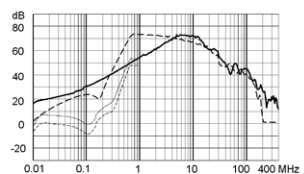



Medical (M5) HP

1 A

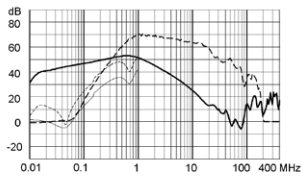

3 A

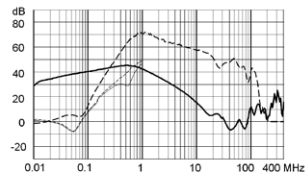

4 A

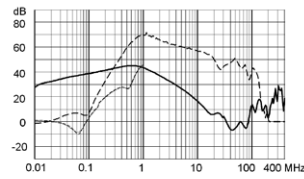

6 A

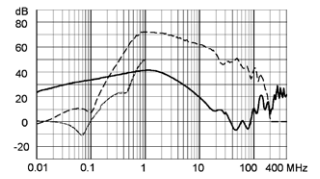

8 A

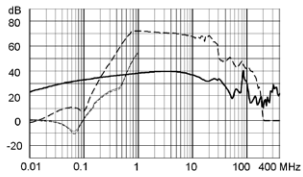

10 A

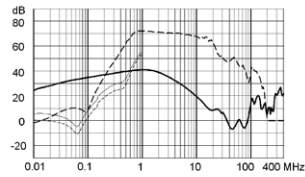

12 A

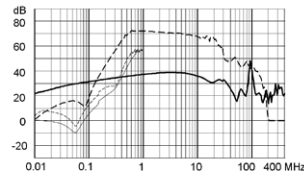

16 A

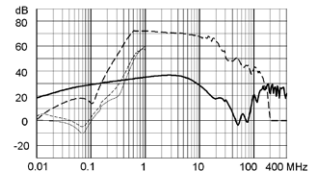

20 A

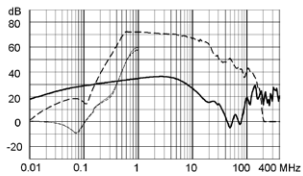

30 A

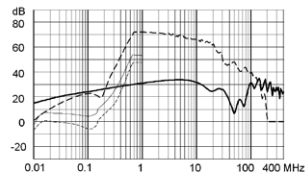

Medical (M80) HP

1 A

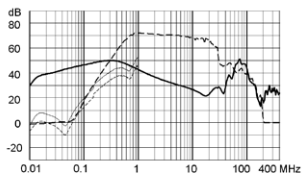

3 A

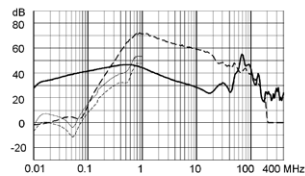

4 A

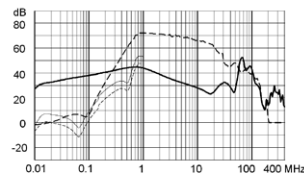

6 A

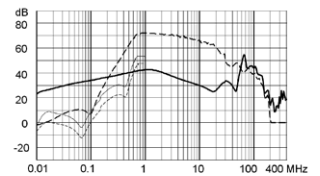

8 A

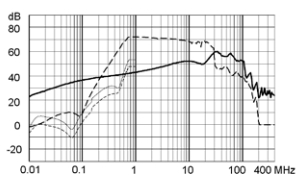

10 A

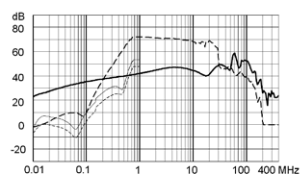

12 A

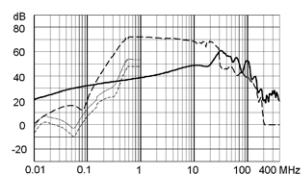

16 A

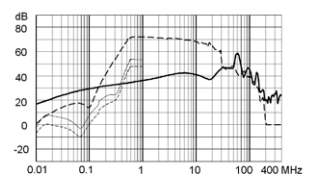

20 A

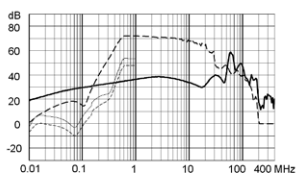

30 A

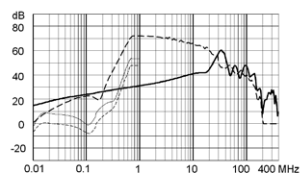

All Variants

Rated current	Filter-Type	Terminal	Design	Pro-tection Class	Leakage Current	Ri	Power Loss	Surge pro-tection	Weight	Housing	Packa-ging	Order Number
[A]					[mA]	[mΩ]	[W]		[g]		[ST]	
1	Standard version	QC 6.3 x 0.8 mm	N	I	0.5	475	1	-	72g	PG	15	5500.2630.01
1	Standard version	QC 6.3 x 0.8 mm	N	I	0.5	475	1	VDR	72g	PG	15	5500.2630.21
1	Standard version	QC 6.3 x 0.8 mm	P	I	0.5	320	0.65	-	80g	QC	15	5500.2640.01
1	Standard version	QC 6.3 x 0.8 mm	Q	I	0.5	320	0.65	-	66g	PG	15	5500.2650.01
3	Standard version	QC 6.3 x 0.8 mm	N	I	0.5	83	1.5	-	104g	PH	15	5500.2631.01
3	Standard version	QC 6.3 x 0.8 mm	N	I	0.5	83	1.5	VDR	104g	PH	15	5500.2631.21
3	Standard version	QC 6.3 x 0.8 mm	P	I	0.5	36	0.65	-	81g	QC	15	5500.2641.01
3	Standard version	QC 6.3 x 0.8 mm	Q	I	0.5	36	0.65	-	70g	PG	15	5500.2651.01
4	Standard version	QC 6.3 x 0.8 mm	N	I	0.5	53	1.7	-	108g	PH	15	5500.2632.01
4	Standard version	QC 6.3 x 0.8 mm	N	I	0.5	53	1.7	VDR	108g	PH	15	5500.2632.21
6	Standard version	QC 6.3 x 0.8 mm	N	I	0.5	32.5	2.4	-	109g	PH	15	5500.2633.01
6	Standard version	QC 6.3 x 0.8 mm	N	I	0.5	32.5	2.4	VDR	109g	PH	15	5500.2633.21
6	Standard version	QC 6.3 x 0.8 mm	P	I	0.5	12	0.86	-	80g	QC	15	5500.2642.01
6	Standard version	QC 6.3 x 0.8 mm	Q	I	0.5	12	0.86	-	100g	PG	15	5500.2652.01
8	Standard version	QC 6.3 x 0.8 mm	N	I	0.5	29.2	3.8	-	190g	PI	10	5500.2634.01
8	Standard version	QC 6.3 x 0.8 mm	N	I	0.5	29.2	3.8	VDR	190g	PI	10	5500.2634.21
10	Standard version	QC 6.3 x 0.8 mm	P	I	0.5	5	1	-	87g	QC	15	5500.2643.01
10	Standard version	QC 6.3 x 0.8 mm	Q	I	0.5	5	1	-	90g	QC	15	5500.2653.01
12	Standard version	QC 6.3 x 0.8 mm	P	I	0.5	4	1.2	-	92g	QC	15	5500.2644.01
12	Standard version	QC 6.3 x 0.8 mm	Q	I	0.5	4	1.2	-	90g	QC	15	5500.2654.01
16	Standard version	QC 6.3 x 0.8 mm	P	I	0.5	2	1	-	138g	QD	15	5500.2645.01
16	Standard version	QC 6.3 x 0.8 mm	Q	I	0.5	2	1	-	136g	QD	15	5500.2655.01
20	Standard version	QC 6.3 x 0.8 mm	P	I	0.5	1.9	1.5	-	206g	PI	10	5500.2646.01
20	Standard version	QC 6.3 x 0.8 mm	Q	I	0.5	1.9	1.5	-	204g	PI	10	5500.2656.01
1	Standard Version with Ground Line Choke	QC 6.3 x 0.8 mm	N	I	1.57	390	1	-	100g	UI	15	3-137-000
3	Standard Version with Ground Line Choke	QC 6.3 x 0.8 mm	N	I	1.57	62	1.2	-	104g	UI	15	3-137-001
4	Standard Version with Ground Line Choke	QC 6.3 x 0.8 mm	N	I	1.57	36	1.3	-	108g	UI	15	3-137-002
6	Standard Version with Ground Line Choke	QC 6.3 x 0.8 mm	N	I	1.57	21	1.6	-	110g	UI	15	3-137-003
8	Standard Version with Ground Line Choke	QC 6.3 x 0.8 mm	N	I	1.57	29	3.8	-	280g	UG	10	3-137-004
10	Standard Version with Ground Line Choke	QC 6.3 x 0.8 mm	N	I	1.57	13	2.6	-	295g	UG	10	3-137-005
12	Standard Version with Ground Line Choke	QC 6.3 x 0.8 mm	N	I	1.57	9	2.6	-	300g	UG	10	3-137-006
16	Standard Version with Ground Line Choke	QC 6.3 x 0.8 mm	N	I	1.57	3.3	2.8	-	310g	UG	10	3-137-007
20	Standard Version with Ground Line Choke	QC 6.3 x 0.8 mm	N	I	1.57	1	3.5	-	322g	UG	10	3-137-008
1	Standard version HP	QC 6.3 x 0.8 mm	N	I	0.74	286	0.57	-	72g	PG	15	3-143-596
3	Standard version HP	QC 6.3 x 0.8 mm	N	I	1.07	55	0.99	-	104g	PH	15	3-143-597
4	Standard version HP	QC 6.3 x 0.8 mm	N	I	1.07	33	1.06	-	108g	PH	15	3-143-598

Rated current	Filter-Type	Terminal	Design	Pro-tection Class	Leakage Current	Ri	Power Loss	Surge pro-tection	Weight	Housing	Packa-ging	Order Number
[A]					[mA]	[mΩ]	[W]		[g]		[ST]	
6	Standard version HP	QC 6.3 x 0.8 mm	N	I	1.07	20.5	1.48	-	109g	PH	15	3-143-599
8	Standard version HP	QC 6.3 x 0.8 mm	N	I	1.57	21.6	2.76	-	190g	PI	10	3-143-600
10	Standard version HP	QC 6.3 x 0.8 mm	N	I	1.57	15.5	3.1	-	200g	PI	10	3-143-601
12	Standard version HP	QC 6.3 x 0.8 mm	N	I	1.57	11	3.17	-	201g	PI	10	3-143-602
16	Standard version HP	QC 6.3 x 0.8 mm	N	I	2.36	6.9	3.53	-	308g	UB	10	3-143-603
20	Standard version HP	QC 6.3 x 0.8 mm	N	I	2.36	6.2	4.96	-	322g	PK	10	3-143-604
30	Standard version HP	QC 6.3 x 0.8 mm	N	I	2.36	2.9	5.2	-	355g	PK	10	3-143-605
60	Industrial version	Bolt and nut M6	P	I	1	1	7.2	-	1220g	QF	1	5500.2648.03
60	Industrial version	Bolt and nut M6	Q	I	1	1	7.2	-	1220g	QF	1	5500.2658.03
10	Industrial version	QC 6.3 x 0.8 mm	N	I	1	22.8	4.6	-	200g	PI	10	5500.2635.01
10	Industrial version	QC 6.3 x 0.8 mm	N	I	1	22.8	4.6	VDR	200g	PI	10	5500.2635.21
12	Industrial version	QC 6.3 x 0.8 mm	N	I	1	13.2	3.8	-	201g	PI	10	5500.2636.01
12	Industrial version	QC 6.3 x 0.8 mm	N	I	1	13.2	3.8	VDR	201g	PI	10	5500.2636.21
16	Industrial version	QC 6.3 x 0.8 mm	N	I	1	7.2	3.7	-	308g	PK	10	5500.2637.01
16	Industrial version	QC 6.3 x 0.8 mm	N	I	1	7.2	3.7	VDR	308g	PK	10	5500.2637.21
20	Industrial version	QC 6.3 x 0.8 mm	N	I	1	6.0	4.8	-	322g	PK	10	5500.2638.01
20	Industrial version	QC 6.3 x 0.8 mm	N	I	1	6.0	4.8	VDR	322g	PK	10	5500.2638.21
30	Industrial version	Bolt and nut M4	N	I	1	2.9	5.2	-	355g	PK	10	5500.2639.03
30	Industrial version	Bolt and nut M4	P	I	1	1	1.8	-	450g	QE	5	5500.2647.03
30	Industrial version	Bolt and nut M4	Q	I	1	1	1.8	-	450g	QE	5	5500.2657.03
1	Medical Version (M5) with Ground Line Choke	QC 6.3 x 0.8 mm	N	I	0.005	390	1	-	100g	UI	15	3-137-009
3	Medical Version (M5) with Ground Line Choke	QC 6.3 x 0.8 mm	N	I	0.005	62	1.2	-	104g	UI	15	3-137-010
4	Medical Version (M5) with Ground Line Choke	QC 6.3 x 0.8 mm	N	I	0.005	36	1.3	-	108g	UI	15	3-137-011
6	Medical Version (M5) with Ground Line Choke	QC 6.3 x 0.8 mm	N	I	0.005	21	1.6	-	110g	UI	15	3-137-012
8	Medical Version (M5) with Ground Line Choke	QC 6.3 x 0.8 mm	N	I	0.005	29	3.8	-	280g	UG	10	3-137-013
10	Medical Version (M5) with Ground Line Choke	QC 6.3 x 0.8 mm	N	I	0.005	13	2.6	-	295g	UG	10	3-137-014
12	Medical Version (M5) with Ground Line Choke	QC 6.3 x 0.8 mm	N	I	0.005	9	2.6	-	300g	UG	10	3-137-015
16	Medical Version (M5) with Ground Line Choke	QC 6.3 x 0.8 mm	N	I	0.005	3.3	2.8	-	310g	UG	10	3-137-016
20	Medical Version (M5) with Ground Line Choke	QC 6.3 x 0.8 mm	N	I	0.005	1	3.5	-	322g	UG	10	3-137-017
1	Medical Version (M80) with Ground Line Choke	QC 6.3 x 0.8 mm	N	I	0.08	390	1	-	100g	UI	15	3-137-018
3	Medical Version (M80) with Ground Line Choke	QC 6.3 x 0.8 mm	N	I	0.08	62	1.2	-	104g	UI	15	3-137-019
4	Medical Version (M80) with Ground Line Choke	QC 6.3 x 0.8 mm	N	I	0.08	36	1.3	-	108g	UI	15	3-137-020

Rated current	Filter-Type	Terminal	Design	Pro-tection Class	Leakage Current	Ri	Power Loss	Surge pro-tection	Weight	Housing	Packa-ging	Order Number
[A]					[mA]	[mΩ]	[W]		[g]		[ST]	
6	Medical Version (M80) with Ground Line Choke	QC 6.3 x 0.8 mm	N	I	0.08	21	1.6	-	110 g	UI	15	3-137-021
8	Medical Version (M80) with Ground Line Choke	QC 6.3 x 0.8 mm	N	I	0.08	29	3.8	-	280 g	UG	10	3-137-022
10	Medical Version (M80) with Ground Line Choke	QC 6.3 x 0.8 mm	N	I	0.08	13	2.6	-	295 g	UG	10	3-137-023
12	Medical Version (M80) with Ground Line Choke	QC 6.3 x 0.8 mm	N	I	0.08	9	2.6	-	300 g	UG	10	3-137-024
16	Medical Version (M80) with Ground Line Choke	QC 6.3 x 0.8 mm	N	I	0.08	3.3	2.8	-	310 g	UG	10	3-137-025
20	Medical Version (M80) with Ground Line Choke	QC 6.3 x 0.8 mm	N	I	0.08	1	3.5	-	322 g	UG	10	3-137-026
60	Medical (M5)	Bolt and nut M6	P	I	0.005	1	7.2	-	1220 g	QF	1	5500.2648.06
60	Medical (M5)	Bolt and nut M6	Q	I	0.005	1	7.2	-	1220 g	QF	1	5500.2658.06
1	Medical (M5)	QC 6.3 x 0.8 mm	N	II	0.005	540	1.08	-	72 g	UL	15	3-134-821
1	Medical (M5)	QC 6.3 x 0.8 mm	N	I	0.005	475	1	-	72 g	PG	15	5500.2630.04
1	Medical (M5)	QC 6.3 x 0.8 mm	P	I	0.005	320	0.65	-	80 g	QC	15	5500.2640.04
1	Medical (M5)	QC 6.3 x 0.8 mm	Q	I	0.005	320	0.65	-	66 g	PG	15	5500.2650.04
3	Medical (M5)	QC 6.3 x 0.8 mm	N	II	0.005	82	1.48	-	104 g	UM	15	3-134-822
3	Medical (M5)	QC 6.3 x 0.8 mm	N	I	0.005	83	1.5	-	104 g	PH	15	5500.2631.04
3	Medical (M5)	QC 6.3 x 0.8 mm	P	I	0.005	36	0.65	-	81 g	QC	15	5500.2641.04
3	Medical (M5)	QC 6.3 x 0.8 mm	Q	I	0.005	36	0.65	-	70 g	PG	15	5500.2651.04
4	Medical (M5)	QC 6.3 x 0.8 mm	N	II	0.005	50	1.6	-	108 g	UM	15	3-134-823
4	Medical (M5)	QC 6.3 x 0.8 mm	N	I	0.005	53	1.7	-	108 g	PH	15	5500.2632.04
6	Medical (M5)	QC 6.3 x 0.8 mm	N	II	0.005	32	2.3	-	110 g	UM	15	3-134-824
6	Medical (M5)	QC 6.3 x 0.8 mm	N	I	0.005	32.5	2.4	-	109 g	PH	15	5500.2633.04
6	Medical (M5)	QC 6.3 x 0.8 mm	P	I	0.005	12	0.86	-	80 g	QC	15	5500.2642.04
6	Medical (M5)	QC 6.3 x 0.8 mm	Q	I	0.005	12	0.86	-	100 g	PG	15	5500.2652.04
8	Medical (M5)	QC 6.3 x 0.8 mm	N	II	0.005	29	3.71	-	188 g	UN	10	3-134-825
8	Medical (M5)	QC 6.3 x 0.8 mm	N	I	0.005	29.2	3.8	-	190 g	PI	10	5500.2634.04
10	Medical (M5)	QC 6.3 x 0.8 mm	N	II	0.005	19	3.8	-	200 g	UN	10	3-134-826
10	Medical (M5)	QC 6.3 x 0.8 mm	N	I	0.005	22.8	4.6	-	200 g	PI	10	5500.2635.04
10	Medical (M5)	QC 6.3 x 0.8 mm	P	I	0.005	5	1	-	87 g	QC	15	5500.2643.04
10	Medical (M5)	QC 6.3 x 0.8 mm	Q	I	0.005	5	1	-	90 g	QC	15	5500.2653.04
12	Medical (M5)	QC 6.3 x 0.8 mm	N	II	0.005	11	3.17	-	200 g	UN	10	3-134-827
12	Medical (M5)	QC 6.3 x 0.8 mm	N	I	0.005	13.2	3.8	-	201 g	PI	10	5500.2636.04
12	Medical (M5)	QC 6.3 x 0.8 mm	P	I	0.005	4	1.2	-	92 g	QC	15	5500.2644.04
12	Medical (M5)	QC 6.3 x 0.8 mm	Q	I	0.005	4	1.2	-	90 g	QC	15	5500.2654.04
16	Medical (M5)	QC 6.3 x 0.8 mm	N	II	0.005	6	3.07	-	310 g	UO	10	3-134-828
16	Medical (M5)	QC 6.3 x 0.8 mm	N	I	0.005	7.2	3.7	-	308 g	PK	10	5500.2637.04
16	Medical (M5)	QC 6.3 x 0.8 mm	P	I	0.005	2	1	-	138 g	QD	15	5500.2645.04
16	Medical (M5)	QC 6.3 x 0.8 mm	Q	I	0.005	2	1	-	136 g	QD	15	5500.2655.04
20	Medical (M5)	QC 6.3 x 0.8 mm	N	II	0.005	5	4	-	322 g	UO	10	3-134-829
20	Medical (M5)	QC 6.3 x 0.8 mm	N	I	0.005	6	4.8	-	322 g	PK	10	5500.2638.04
20	Medical (M5)	QC 6.3 x 0.8 mm	P	I	0.005	1.9	1.5	-	206 g	PI	10	5500.2646.04

Rated current	Filter-Type	Terminal	Design	Pro-tection Class	Leakage Current	Ri	Power Loss	Surge pro-tection	Weight	Housing	Packa-ging	Order Number
[A]					[mA]	[mΩ]	[W]		[g]		[ST]	
20	Medical (M5)	QC 6.3 x 0.8 mm	Q	I	0.005	1.9	1.5	-	204 g	PI	10	5500.2656.04
30	Medical (M5)	Bolt and nut M4	N	I	0.005	2.9	5.2	-	355 g	PK	10	5500.2639.06
30	Medical (M5)	Bolt and nut M4	P	I	0.005	1	1.8	-	450 g	QE	5	5500.2647.06
30	Medical (M5)	Bolt and nut M4	Q	I	0.005	1	1.8	-	450 g	QE	5	5500.2657.06
60	Medical (M80)	Bolt and nut M6	P	I	0.08	1	7.2	-	1220 g	QF	1	5500.2648.09
60	Medical (M80)	Bolt and nut M6	Q	I	0.08	1	7.2	-	1220 g	QF	1	5500.2658.09
1	Medical (M80)	QC 6.3 x 0.8 mm	N	I	0.08	475	1	-	72 g	PG	15	5500.2630.07
1	Medical (M80)	QC 6.3 x 0.8 mm	P	I	0.08	320	0.65	-	80 g	QC	15	5500.2640.07
1	Medical (M80)	QC 6.3 x 0.8 mm	Q	I	0.08	320	0.65	-	66 g	PG	15	5500.2650.07
3	Medical (M80)	QC 6.3 x 0.8 mm	N	I	0.08	83	1.5	-	104 g	PH	15	5500.2631.07
3	Medical (M80)	QC 6.3 x 0.8 mm	P	I	0.08	36	0.65	-	81 g	QC	15	5500.2641.07
3	Medical (M80)	QC 6.3 x 0.8 mm	Q	I	0.08	36	0.65	-	70 g	PG	15	5500.2651.07
4	Medical (M80)	QC 6.3 x 0.8 mm	N	I	0.08	53	1.7	-	108 g	PH	15	5500.2632.07
6	Medical (M80)	QC 6.3 x 0.8 mm	N	I	0.08	32.5	2.4	-	109 g	PH	15	5500.2633.07
6	Medical (M80)	QC 6.3 x 0.8 mm	P	I	0.08	12	0.86	-	80 g	QC	15	5500.2642.07
6	Medical (M80)	QC 6.3 x 0.8 mm	Q	I	0.08	12	0.86	-	100 g	PG	15	5500.2652.07
8	Medical (M80)	QC 6.3 x 0.8 mm	N	I	0.08	29.2	3.8	-	190 g	PI	10	5500.2634.07
10	Medical (M80)	QC 6.3 x 0.8 mm	N	I	0.08	22.8	4.6	-	200 g	PI	10	5500.2635.07
10	Medical (M80)	QC 6.3 x 0.8 mm	P	I	0.08	5	1	-	87 g	QC	15	5500.2643.07
10	Medical (M80)	QC 6.3 x 0.8 mm	Q	I	0.08	5	1	-	90 g	QC	15	5500.2653.07
12	Medical (M80)	QC 6.3 x 0.8 mm	N	I	0.08	13.2	3.8	-	201 g	PI	10	5500.2636.07
12	Medical (M80)	QC 6.3 x 0.8 mm	P	I	0.08	4	1.2	-	92 g	QC	15	5500.2644.07
12	Medical (M80)	QC 6.3 x 0.8 mm	Q	I	0.08	4	1.2	-	90 g	QC	15	5500.2654.07
16	Medical (M80)	QC 6.3 x 0.8 mm	N	I	0.08	7.2	3.7	-	308 g	PK	10	5500.2637.07
16	Medical (M80)	QC 6.3 x 0.8 mm	P	I	0.08	2	1	-	138 g	QD	15	5500.2645.07
16	Medical (M80)	QC 6.3 x 0.8 mm	Q	I	0.08	2	1	-	136 g	QD	15	5500.2655.07
20	Medical (M80)	QC 6.3 x 0.8 mm	N	I	0.08	6.0	4.8	-	322 g	PK	10	5500.2638.07
20	Medical (M80)	QC 6.3 x 0.8 mm	P	I	0.08	1.9	1.5	-	206 g	PI	10	5500.2646.07
20	Medical (M80)	QC 6.3 x 0.8 mm	Q	I	0.08	1.9	1.5	-	204 g	PI	10	5500.2656.07
30	Medical (M80)	Bolt and nut M4	N	I	0.08	2.9	5.2	-	355 g	PK	10	5500.2639.09
30	Medical (M80)	Bolt and nut M4	P	I	0.08	1	1.8	-	450 g	QE	5	5500.2647.09
30	Medical (M80)	Bolt and nut M4	Q	I	0.08	1	1.8	-	450 g	QE	5	5500.2657.09
1	Medical (M5) HP	QC 6.3 x 0.8 mm	N	II	0.005	280	0.56	-	72 g	UL	15	3-134-830
1	Medical (M5) HP	QC 6.3 x 0.8 mm	N	I	0.005	286	0.57	-	72 g	PG	15	3-143-606
3	Medical (M5) HP	QC 6.3 x 0.8 mm	N	II	0.005	50	0.9	-	104 g	UM	15	3-134-831
3	Medical (M5) HP	QC 6.3 x 0.8 mm	N	I	0.005	55	0.99	-	104 g	PH	15	3-143-607
4	Medical (M5) HP	QC 6.3 x 0.8 mm	N	II	0.005	30	0.96	-	108 g	UM	15	3-134-832
4	Medical (M5) HP	QC 6.3 x 0.8 mm	N	I	0.005	33	1.06	-	108 g	PH	15	3-143-608
6	Medical (M5) HP	QC 6.3 x 0.8 mm	N	II	0.005	16.4	1.18	-	110 g	UM	15	3-134-833
6	Medical (M5) HP	QC 6.3 x 0.8 mm	N	I	0.005	20.5	1.48	-	109 g	PH	15	3-143-609
8	Medical (M5) HP	QC 6.3 x 0.8 mm	N	II	0.005	18.5	2.37	-	188 g	UN	10	3-134-834
8	Medical (M5) HP	QC 6.3 x 0.8 mm	N	I	0.005	21.6	2.76	-	190 g	PI	10	3-143-610
10	Medical (M5) HP	QC 6.3 x 0.8 mm	N	II	0.005	12.5	2.5	-	200 g	UN	10	3-134-835
10	Medical (M5) HP	QC 6.3 x 0.8 mm	N	I	0.005	15.5	3.1	-	200 g	PI	10	3-143-611
12	Medical (M5) HP	QC 6.3 x 0.8 mm	N	II	0.005	7.9	2.28	-	200 g	UN	10	3-134-836
12	Medical (M5) HP	QC 6.3 x 0.8 mm	N	I	0.005	11	3.17	-	201 g	PI	10	3-143-612

Rated current	Filter-Type	Terminal	Design	Pro-tection Class	Leakage Current	Ri	Power Loss	Surge pro-tection	Weight	Housing	Packa-ging	Order Number
[A]					[mA]	[mΩ]	[W]		[g]		[ST]	
16	Medical (M5) HP	QC 6.3 x 0.8 mm	N	II	0.005	4.2	2.15	-	310 g	UO	10	3-134-837
16	Medical (M5) HP	QC 6.3 x 0.8 mm	N	I	0.005	6.9	3.53	-	308 g	UB	10	3-143-613
20	Medical (M5) HP	QC 6.3 x 0.8 mm	N	II	0.005	3.4	2.72	-	322 g	UO	10	3-134-838
20	Medical (M5) HP	QC 6.3 x 0.8 mm	N	I	0.005	6.2	4.96	-	322 g	PK	10	3-143-614
30	Medical (M5) HP	QC 6.3 x 0.8 mm	N	I	0.005	2.9	5.2	-	355 g	PK	10	3-143-615
1	Medical (M80) HP	QC 6.3 x 0.8 mm	N	I	0.08	286	0.57	-	72 g	PG	15	3-143-616
3	Medical (M80) HP	QC 6.3 x 0.8 mm	N	I	0.08	55	0.99	-	104 g	PH	15	3-143-617
4	Medical (M80) HP	QC 6.3 x 0.8 mm	N	I	0.08	33	1.06	-	108 g	PH	15	3-143-618
6	Medical (M80) HP	QC 6.3 x 0.8 mm	N	I	0.08	20.5	1.48	-	109 g	PH	15	3-143-619
8	Medical (M80) HP	QC 6.3 x 0.8 mm	N	I	0.08	21.6	2.76	-	190 g	PI	10	3-143-620
10	Medical (M80) HP	QC 6.3 x 0.8 mm	N	I	0.08	15.5	3.1	-	200 g	PI	10	3-143-621
12	Medical (M80) HP	QC 6.3 x 0.8 mm	N	I	0.08	11	3.17	-	201 g	PI	10	3-143-622
16	Medical (M80) HP	QC 6.3 x 0.8 mm	N	I	0.08	6.9	3.53	-	308 g	UB	10	3-143-623
20	Medical (M80) HP	QC 6.3 x 0.8 mm	N	I	0.08	6.2	4.96	-	322 g	PK	10	3-143-624
30	Medical (M80) HP	QC 6.3 x 0.8 mm	N	I	0.08	2.9	5.2	-	355 g	PK	10	3-143-625

Most Popular.

Availability for all products can be searched real-time: <https://www.schurter.com/en/Stock-Check/Stock-Check-SCHURTER>

- 4 designs N) excellent symmetrical noise attenuation
- P) high symmetrical noise attenuation
- Q) standard symmetrical noise attenuation
- HP) high performance

60A medical filter M5 and M80, design P, are only suitable for medical equipment intended for permanently connection to the mains.

## Accessories

### Description



[DIN\\_Rail\\_Kit](#)  
 Mounting accessory for compact 1- and 3-phase filters